



TENDER #3857

RECLADDING

ATLANTIC MEMORIAL - TERENCE BAY ELEMENTARY SITE

Closing Date: FRIDAY SEPTEMBER 30TH, 2016
Closing/Opening Time: 2:00:00 P.M.

Closing Location:
Halifax Regional School Board
33 Spectacle Lake Drive
Dartmouth, N.S. B3B 1X7

Substantial Completion Date:
OCTOBER 31ST 2016

HRSB Contacts:
Jennifer King, Buyer

Tel: (902) 464-2000 #2223
Fax: (902) 464-0161
Email: jlking@hrsb.ca

School Location:
ATLANTIC MEMORIAL
(TERENCE BAY ELEMENTARY SITE)
1714 LOWER PROSPECT RD
TERENCE BAY NS, B3T 1Y6

Operations Contact:
Ted Moore, Regional Manager
Tel: (902) 464-2000 #4398
Email: tmoore@hrsb.ca

A mandatory bidders' site meeting is scheduled for **TUESDAY SEPTEMBER 20TH, AT 10:00AM AT THE FRONT ENTRANCE OF THE SCHOOL – 1714 LOWER PROSPECT RD.**

To obtain documents:
Download tender documents in .pdf format from the School Board's Website:
<http://www.hrsb.ca/about-hrsb/financial-services/purchasing/tenders/tender-listing>

The Halifax Regional School Board encourages equity and affirmative action programs.

SECTION 00 00 01 - TABLE OF CONTENTS

SECTION 00 00 15 - DESCRIPTION OF WORK & LIST OF DRAWINGS..... 3

SECTION 00 05 00 - LIST OF CONSULTANTS 4

SECTION 00 21 13 – INFORMATION FOR BIDDERS 5

SECTION 00 41 13 - TENDER FORM..... 20

SECTION 00 41 73 - TENDER AMENDMENT FORM 27

SECTION 00 52 00 - AGREEMENT BETWEEN OWNER AND CONTRACTOR 28

SECTION 00 52 13 - DEFINITIONS 29

SECTION 00 72 13 - GENERAL CONDITIONS..... 30

SECTION 00 73 00 - SUPPLEMENTARY GENERAL CONDITIONS CCDC2 – 2008..... 31

SECTION 00 73 10 - HRSB GENERAL TERMS & CONDITIONS 51

SECTION 01 11 00 - HRSB SUMMARY OF WORK 61

SECTION 01 11 25 - PRICES..... 68

SECTION 01 11 41 - PROJECT COORDINATION..... 70

SECTION 01 31 19 – PROJECT MEETINGS 73

SECTION 01 33 00 – SUBMITTAL PROCEDURES..... 76

SECTION 01 35 13 – APPENDIX A - SPECIAL PROJECT PROCEDURES 85

SECTION 01 35 29 - OCCUPATIONAL HEALTH & SAFETY REQUIREMENTS..... 95

SECTION 01 37 00 - SCHEDULE OF VALUES..... 101

SECTION 01 41 00 - REGULATORY AGENCIES 104

SECTION 01 45 00 - QUALITY CONTROL 108

SECTION 01 52 00 – CONSTRUCTION & TEMPORARY FACILITIES 112

SECTION 01 61 00 - MATERIAL & EQUIPMENT 115

SECTION 01 77 00 – CONTRACT CLOSEOUT 118

CONTRACTOR’S CHECKLIST 123

HRSB SAFETY PLAN..... 124

ASBESTOS SURVEY – MARITIME TESTING – MARCH 1999 (FOR REFERENCE)..... 129

SECTION 00 00 15 - DESCRIPTION OF WORK & LIST OF DRAWINGS

1. General

- 1.1.** The work of this contract includes the provision of all materials, labour and equipment necessary to complete the **RECLADDING** project at **TERENCE BAY ELEMENTARY SITE**, as per the documentation, drawings and specifications prepared by **Fowler Bauld & Mitchell Ltd.**
- 1.2.** It is the School Board's intent to have all work completed, to point of Substantial Performance, prior to **OCTOBER 31, 2016**. The Building will be occupied during this time period. It is expected that an early award of this contract will enable the Contractor to facilitate shop drawing review and ordering of materials to allow commencement of work immediately following award of tender.
- 1.3.** The whole of the work shall agree in all particulars with the levels, measurements and details contained in the drawings accompanying this specification and with such other drawings or information as may from time to time be supplied by the School Board, or may be supplied by the Contractor and reviewed by the School Board.

2. List Of Drawings

<u>Drawing NO.</u>	<u>Drawing Title</u>
A-0	General Notes
A-1	Floor Plans
A-2	Building Elevations: Existing Conditions
A-3	Building Elevations: New Conditions
A-4	Cladding Details
A-5	Cladding Details

END OF SECTION 00 00 15

##3857 RECLADDING – TERENCE BAY ELEMENTARY

SECTION 00 05 00 - LIST OF CONSULTANTS

Owner: HALIFAX REGIONAL SCHOOL BOARD
33 SPECTACLE LAKE DRIVE, DARTMOUTH NS

Architect: Mark Gammon
Fowler Bauld & Mitchell Ltd.
Phone: 902-429-4100 x 109
Email: gammon@fbm.ca

END OF SECTION 00 05 00

SECTION 00 21 13 – INFORMATION FOR BIDDERS

Invitation:

1. Bid Call

- 1.1.** The HALIFAX REGIONAL SCHOOL BOARD (The Board/HRSB) will receive offers in the form of a bid from Contractors which is signed and received on or before the date and time specified on the cover sheet of this document. HRSB deems the correct time to be the time indicated on the phone clock on the Receptionist's desk at at 33 Spectacle Lake Drive.
- 1.2.** Offers submitted after the closing time/date shall be returned to the bidder unopened.
- 1.3.** Submit completed tender documents for above project in sealed envelope marked as follows: **TENDER #3857 - RECLADDING – TERENCE BAY ELEMENTARY**
- 1.4.** Bids will be opened at the time indicated on the cover sheet of this document. As of April 1, 2014 Public tender openings are no longer held for any tenders relating to goods, services or construction for HRSB. A list of bidders and bid amounts will be posted on the Procurement Services website (<http://novascotia.ca/tenders/tenders/ns-tenders.aspx>) shortly following the closing of the tender. All bid submissions are subject to evaluation after opening and before award of contract. The winning bidder and award amount will be posted on the Procurement Services website (<http://novascotia.ca/tenders/tenders/ns-tenders.aspx>) after award.
- 1.5.** In the event that the HALIFAX REGIONAL SCHOOL BOARD office is closed due to inclement weather or any other reason on the date and at the time of closing, the Closing Date and Time will be extended one (1) business day. Proponents should note that closure of Schools does not necessarily mean closure of the Board's Regional Office.
- 1.6.** Amendments to the submitted offer will be permitted if received in writing prior to bid closing and if endorsed by the same party or parties who signed and executed the offer.
- 1.7.** Emailed/Faxed Bid Submissions **will not** be accepted.

2. Intent

- 2.1.** The intent of this bid call is to obtain an offer to perform all work associated with Tender #3857, **RECLADDING**, at **TERENCE BAY ELEMENTARY SITE** for a Stipulated Price Contract in accordance with the Contract Documents.

3. Scope of work

- 3.1.** Refer to Section 00 00 15 – Description of Work and List of Drawings.

4. Availability

- 4.1.** Bid Documents can be obtained as per the directions on the cover sheet of this document.
- 4.2.** Bid Documents are made available only for the purpose of obtaining offers for this project. Their use does not confer a license or grant for other purposes.
- 4.3.** The HALIFAX REGIONAL SCHOOL BOARD is not responsible for accuracy of documents and project postings obtained from any other source.

5. Examination

- 5.1.** Bid Documents are on display at the offices of the Nova Scotia Construction Association (CANS), Halifax, NS.
- 5.2.** Upon receipt of Bid Documents verify that documents are complete; notify the Board's Buyer by email to ilking@hrsb.ca, should the documents be incomplete, or upon finding discrepancies or omissions in the Bid Documents.
- 5.3.** Bidders shall become fully aware of the content of all tender documents for the preparation of the Bidder's offer.
- 5.4.** Bidders will be deemed to have familiarized themselves with the existing site and working conditions and all other conditions which may affect the performance of the work. No plea of ignorance of such conditions as a result of failure to make all necessary examinations will be accepted as a basis for any claims for extra compensation or an extension of time.

6. Clarification and Addenda

- 6.1.** Notify Jennifer King, Buyer, by email to ilking@hrsb.ca no less than **five (5)** working days before Tender Closing of any questions, omissions, errors or ambiguities found in Contract Documents. If HRSB considers that correction, explanation or interpretation is necessary, a reply will be in the form of an addendum, a copy of which will be posted on the novascotia.ca/tenders and/or HRSB website as applicable, and it is the responsibility of the Bidder to ensure all addenda are received and acknowledged.

##3857 RECLADDING – TERENCE BAY ELEMENTARY

- 6.2. Addenda will be issued no less than three (3) business days before tender closing date and time, and will form part of the Contract Documents.
- 6.3. Verbal answers to queries are not binding. Information must be confirmed by written addenda. The Board and its representatives shall not be bound by or be liable for any representation or information provided verbally. Information obtained by any other source is not official and will not bind the HALIFAX REGIONAL SCHOOL BOARD.
- 6.4. Complete tender form (section 00 41 13) acknowledging that addenda have been received.

7. Product/System Options

- 7.1. Alternatives to specified products and systems will only be considered during the bidding period in the manner prescribed below.
 - 7.1.1. Where the Bid Documents stipulate a particular product, alternatives may be considered by the Consultant up to five (5) working days before tender closing date and time. Bidders must forward their written requests by email to: ijking@hrsb.ca. The Buyer will relay the requests to the appropriate person(s) for review.
- 7.2. The submission must provide sufficient information to enable the Consultant to determine acceptability of such products. Request for an alternate must be accompanied with:
 - 7.2.1. information about how the request affects other work in order to accommodate each alternate;
 - 7.2.2. the dollar amount of additions to or reductions from the Bid Price, including revisions to other Work.

A later claim by the bidder for an addition to the contract price because of changes in work necessitated by use of alternates shall not be considered.
- 7.3. When a request to substitute a product is made and pursuant to consultation with the Consultant, HRSB may approve or disapprove the substitution. The bidder making the request will be notified of the Board's decision and if the alternate is approved, HRSB will issue an Addendum.
- 7.4. Alternates must be submitted in above manner; otherwise, they will not be accepted.

8. Mandatory Bidders' Site Meeting (Site Assessment)

8.1. Bidders will be deemed to have familiarized themselves with existing project site and working conditions and all other conditions, which may affect performance of the Contract. No plea of ignorance of such conditions as a result of failure to make all necessary examinations will be accepted as a basis for any claims for extra compensation or an extension of time.

8.1.1.A Mandatory Bidders' Site Meeting has been scheduled as per the information on the cover sheet of this document. All Bidders are required to attend. Representatives of HRSB and the Consultant will be in attendance;

9. Bidders Registration

9.1. The successful Contractor and Sub-contractors must comply with the Nova Scotia Corporations Registration Act or Partnerships and Business Name Registration Act, or equivalent, before a contract is awarded.

10. Qualifications

10.1. Sub-Contractors

10.1.1. HRSB reserves the right to reject a proposed sub-contractor for a reasonable cause.

10.1.2. Refer to Article GC 3.7.3 of CCDC-2 2008.

11. Bid Submission

11.1. Submissions

11.1.1. Bidders shall be solely responsible for the delivery of their bids in the manner and time prescribed.

11.1.2. Bids must be submitted on the **Bid Form** provided by HRSB (Section 00 41 13 – Bid Form). These forms are to be completely filled out in ink, with the signature in longhand, and corporate sealed as applicable, and the completed form shall be without interlineations, alterations or erasures. Electronic bid submissions sent by facsimile transmission or email will not be accepted.

11.1.3. Fully complete the Tender Bid Form and enter the contract price in both written words and numerals. Where this bid is requested in both words and numbers, and if the two (2) do not represent the identical amount, words shall prevail.

- 11.1.4. Submit the executed offer on the Bid Forms together with the required bid security in a closed opaque envelope, clearly identified with bidder's name, project name and tender number on the outside.
- 11.1.5. Improperly completed information, irregularities in the bid security, may be cause to declare the bid informal.

12. Accuracy of Referencing

- 12.1. Indexing and cross-referencing are for convenience only.

13. Conditions of Tendering

- 13.1. Take full cognizance of content of all Contract Documents in preparation of Tender. Refer to Section 00 41 13 – Tender Form, Subsection 5.0 for a complete list of Contract Documents.

14. Preparation of Tender

- 14.1. Complete Tender Bid Form (section 00 41 13) provided with Contract Documents in ink. Tender all items and fill in all blanks. Have corrections initialed by person signing Tender. Bidders' are required to provide all information as detailed.

15. Amendment or Withdrawal of Tender

- 15.1. Bids may be amended or withdrawn by post, hand or facsimile prior to date and time of closing.
- 15.2. A Tender Price Amendment Form is provided immediately following the Bid Form (section 00 41 73).
 - 15.2.1.1. The Tender Price Amendment Form provided is the standard Master form for submission of all tender price amendments for this project.
 - 15.2.1.2. Copy and complete form, as directed, for all tender price amendments submitted.
- 15.3. Amendments shall not disclose either original or revised total price.
- 15.4. Sign, execute and submit to HRSB Board Office or by facsimile to (902) 464-0161 prior to time of Tender Closing.

16. Bid Ineligibility (reason for rejection)

- 16.1. HRSB may reject a bid which has been received prior to the closing time where:
 - 16.1.1. The bid is not submitted on the required bid form (Section 00 41 13) included herein.
 - 16.1.2. The bid is submitted by electronic transmission.

##3857 RECLADDING – TERENCE BAY ELEMENTARY

- 16.1.3. There are omissions of information that HRSB in its sole discretion deems to be significant.
- 16.1.4. The bid is not signed as required.
- 16.1.5. The bid has conditions attached which are not authorized by the invitation to bid.
- 16.1.6. The bid fails to meet one or more standards specified in the invitation to bid.
- 16.1.7. All addenda have not been acknowledged.
- 16.1.8. Any other defect which, in the opinion of the HRSB brings the meaning of the bid into question.
- 16.1.9. A major irregularity is a deviation from the bid request which affects the price, quality, quantity, or delivery of the project and is material to the award, and is a reason for rejection.
- 16.1.10. A minor irregularity is a deviation from the bid request which affects form, rather than substance. The effect on price, quality, quantity or delivery is not material to the award, and may be waived by the HRSB.
- 16.1.11. The required bid security in the required form is not provided.
- 16.1.12. Bidder failed to attend Bidders' Mandatory Site Meeting.

17. Communications Affecting Bids

- 17.1. Electronic Transmissions, including, but not limited to facsimile transmission:
 - 17.1.1. Bid forms submitted by facsimile and/or e-mail etc. transmission are not acceptable and will be rejected.
 - 17.1.2. Electronic transmissions (facsimile only) modifying bidder supplied information are acceptable when signed by an authorized signatory of the original bid. Submission and receipt of such electronic transmissions is at the risk of the bidder. HRSB assumes no liability for the receipt of the electronic transmission or for their proper inclusion with original bid. There is no requirement for HRSB to follow up upon receipt of an electronic transmission. Electronic submissions will be considered binding on both parties. Electronic submissions must be submitted and received prior to closing time and date specified in the bid documents. HRSB Procurement Department Date and Time stamps will prevail. **HRSB Procurement facsimile number is 902-464-0161.**

18. Right to Accept or Reject any Tender

- 18.1.** The Board reserves the right to reject any bid in its sole and absolute discretion for any reason whatsoever.
- 18.2.** The Board specifically reserves the right to reject all bids if none is considered to be satisfactory in the Board's sole and absolute discretion and, in that event, at its option, to call for additional bids.
- 18.3.** Without limiting the generality of any other provision herein, the Board reserves the right to accept or reject any bid in accordance with bullet #16 above. (Bid Ineligibility)
- 18.4.** Notwithstanding the above, the Board shall be entitled, in its sole and absolute discretion, to waive any irregularity, informality or non-conformance with these instructions in any proposal received by the Board. HRSB reserves the right to reject any or all tenders, or to accept any tender, or portion thereof, deemed in its best interest.
- 18.5.** In the event that a number of Bidders submit bids in substantially the same amount, the Board may, at its discretion, call upon those Bidders to submit further bids or take into consideration any value added services being provide in determination of award.
- 18.6.** No term or condition shall be implied, based upon any industry or trade practice or custom or in a practice or policy of the Board or otherwise, which is inconsistent or conflicts with the provisions contained in these Instructions.

19. Construction Contract Guidelines

- 19.1.** The printed policies of the Nova Scotia Construction Guidelines, dated May 18, 2006 (or latest revisions) are applicable to these bid documents.

20. Bid and Security Forms – Signatures

- 20.1.** All bid forms, bid security forms and performance assurance forms **must** bear the Bidder's original signature and name HRSB as insured.

21. Bid Security

- 21.1.** Submit with Bid one of the following: Bid security in the form of a Certified Cheque, Irrevocable Letter of Credit, or Bid Bond on CCDC Form 220, in the amount of ten percent (10%) of the Bid Price made payable to, or naming HRSB (as obligee), must accompany the tender.
- 21.2.** Where bid bond is provided as bid security:
- 21.2.1.** Provide bond on the standard CCDC Bid Bond Form, latest version, in the amount of not less than ten percent (10%) of the Bid Price.
- 21.2.2.** Bid Bonds, submitted by the general contractor bidder, signed and sealed by the principal (Contractor) and Surety and shall be with an established Surety Company satisfactory to and approved by HRSB.
- 21.2.3.** Where Bid Bond is used as Bid Security, include the cost of providing the Bid Bond in the Bid Price.
- 21.3.** Where certified cheque or bank draft is provided as bid security:
- 21.3.1.** Provide a certified cheque or bank draft, endorsed in the name of HRSB, for a sum not less than ten percent (10%) of the amount of the Bid Price.
- 21.3.2.** Where certified cheque or bank draft is used as Bid Security, include the cost in the Bid Price.
- 21.4.** Where the Irrevocable Standby Letter of Credit is used as bid security:
- 21.4.1.** Provide an Irrevocable Standby Letter, endorsed in the name of HRSB, for a sum not less than ten percent (10%) of the Bid Price
- 21.4.2.** The Irrevocable Standby Letter of Credit shall be issued by a certified financial institution subject to the Uniform Custom and Practices for Documentary Credit (1993 revision or latest revision) International Chamber of Commerce (Publication No. 500).
- 21.4.3.** Where Irrevocable Standby Letter of Credit is used as bid security, include the cost in the Bid Price.
- 21.5.** Return of Bid Security:
- 21.5.1.** The bid security of the unsuccessful bidders will be returned to them after the contract has been signed, or previous to such time, at the discretion of HRSB.
- 21.5.2.** The above shall apply provided a contract is awarded within ninety (90) days from the closing date of the bid.
- 21.5.3.** If no contract is awarded, all bid security will be returned.

22. Contract Security (Performance Assurance)

- 22.1.** All bid forms, bid security forms and performance assurance forms must bear the bidder's original signature and name HRSB as insured.
- 22.2.** Bidder shall maintain performance assurance in force for a period of not less than twelve (12) months after the issue of the substantial performance certificate certified by HRSB and until completion of the contract.
- 22.3.** Endorse Performance Assurance as specified for bid security.
- 22.4.** Should it become apparent that the final cost of the project will exceed the total amount payable by more than 20%, the bidder shall arrange to have their bonds reissued based on the projected final cost.
- 22.5.** Refer to Section 00 72 13 – General Conditions GC11.2 and Section 00 73 00 – Supplementary General Conditions for form of Contract Security. Refer to project documents for amount of Contract Security and alternate type of Contract Security if applicable.
- 22.6.** Submit as Performance Assurance one of the following:
 - 22.6.1.** Where a Bid Bond was used as bid security:
 - 22.6.1.1.** Within ten (10) days after notification of award of the Contract, provide a Performance Bond and a Labour & Material Payment Bond, each in an amount equal to fifty percent (50%) of the amount of the Contract, naming HRSB.
 - 22.6.1.2.** Performance Bond and Labour and Material Payment Bonds, submitted by the bidders, shall be provided at the expense of the bidder and shall be with an established Surety Company satisfactory to and approved by HRSB.
 - 22.6.1.3.** Include the cost of providing the Performance Bond and Labour and Material bond in the Contract price.
 - 22.6.2.** Where a Certified Cheque or Bank Draft is used as Contract Security:
 - 22.6.2.1.** The Certified Cheque or Bank Draft submitted during the bid period will be cashed and the amount retained by HRSB shall serve as Performance Assurance, including the payment of all obligations arising under the Contract.
 - 22.6.2.2.** The Certified Cheque or Bank Draft will be held in lieu of the Performance Bond and Labour and Material Bonds, providing that, at Contract award, the successful Bidder shall supplement their Certified

- Cheque or Bank Draft to maintain an amount of ten (10%) of the total amount payable (Contract Price plus HST) under the contract.
- 22.6.2.3.** The amount remaining will be returned without interest after a period of not less than twelve (12) months after the issue of the substantial performance certificate certified by HRSB and shall serve as performance assurance and not until completion of the contract.
- 22.6.2.4.** Where certified cheque or bank draft is used as Performance Assurance, include the cost of providing the certified cheque in the Contract price.
- 22.6.3.** Where an Irrevocable Standby Letter or Credit is used as Contract Security:
- 22.6.3.1.** The Irrevocable Standby Letter of Credit submitted during the bid period will be retained by HRSB and shall serve as performance assurance, including the payment of all obligations arising under the contract. The irrevocable standby letter of credit shall be issued by a certified financial institution subject to the Uniform Customs and Practices for Documentary Credit (1993 revision) International Chamber of Commerce (Publication No. 500).
- 22.6.3.2.** Where irrevocable standby letter of credit is used as Performance Assurance, include the cost of providing and Irrevocable Standby Letter of Credit in the Contract Price. The contractor shall provide to HRSB documentation throughout the duration of the contract that the irrevocable standby letter of credit remains in full effect at all times as specified,
- 22.6.3.3.** Upon expiry of the Irrevocable Standby Letter of Credit, a separate Irrevocable Standby Letter of Credit shall be provided for work requiring extended warranties for such amounts as are required by the contract.
- 22.6.3.4.** The Irrevocable Standby Letter of Credit is to be in effect for a period of not less than twelve (12) months after the issue of the substantial performance certificate certified by HRSB and shall serve as performance assurance and not until completion of the contract.

23. Insurance

- 23.1.** Refer to Section 00 72 13 -General Conditions of Contract, GC 11.1 – Insurance and Section 00 73 00 – Supplementary General Conditions for form of Insurance. Refer to project documents for amount of insurance, duration of coverage and alternate type of Insurance if applicable.
- 23.2.** General Contractor shall secure and maintain at its expense during the term of the Insurance:
- 23.2.1.** Workers’ Compensation to meet Statuary requirements and/or Employers Liability.
- 23.2.2.** Wrap Up liability Insurance must insure the general contractor(s) and all sub-contractors on this project:
- 23.2.2.1.** including but not limited to, products liability and completed operations, contractual liability, owners and contractors liability, attached machinery extension endorsement, independent contractor, for a combined single limit of no less than \$5,000,000.00 per occurrence.
- 23.2.3.** Commercial Auto Liability insurance covering all owned, non-owned and hired vehicles for a minimum combined single coverage of \$2,000,000.00 per occurrence.
- 23.2.4.** Builders Risk – all risks – in the amount of the project contract stipulated bid price.
- 23.2.5.** Deliver a certificate of insurance evidencing the above prior to work being performed. It is also agreed that the above insurance coverage is primary and must be kept in force during the term of this agreement. Furthermore, HRSB must receive, in writing, at least thirty (30) days’ notice of cancellation or modification of the above insurances. All insurance policies or certification documents shall specify coverage being applicable to this contract. The Contractor shall not do or omit to do or suffer anything to be done or omitted to be done which will in any way impair or invalidate such policy or policies of insurance.
- 23.3.** Primary Insurance- Supplier agrees that the insurance as required above shall be primary and non-contributory.
- 23.4.** No limitation- Supplier is responsible for determining whether the above minimum insurance coverage’s are adequate to protect its interests. The above minimum coverage’s do not constitute limitations upon Supplier’s Liability.
- 23.5.** Endorsements – For the policies in para 23 above, there shall contain an endorsement naming HRSB and its Affiliates as an Additional Insureds, and eliminating and removing any exclusion of liability for:

##3857 RECLADDING – TERENCE BAY ELEMENTARY

- 23.5.1. injury, including bodily injury and death to an employee of the insured or of HRSB, or
- 23.5.2. any obligation of the insured to indemnify, hold harmless, defend, or otherwise make contribution to School Board because of damage arising out of injury, including bodily injury and death, to an employee of HRSB.

24. Proof of Competency of Bidder

- 24.1. Any bidder may be required to furnish evidence satisfactory to the owner that he and his proposed sub-contractors have sufficient means and experience in the types of work called for to assure completion of the contract in a satisfactory manner.
 - 24.1.1. The successful bidder **must** be a member in good standing with CRCA, RCANS; and
 - 24.1.2. Nova Scotia Construction Safety Association or approved recognized association or program.

25. Bid Form Requirements

25.1. Bid Submission

- 25.1.1.1. Bidders shall be solely responsible for the delivery of their bids in the manner and time prescribed.
- 25.1.1.2. Bids must be submitted on forms provided by the Board. These forms are to be completely filled out in ink or by typewriter, with the signature in longhand, and the completed form shall be without interlineations, alterations or erasures.
- 25.1.1.3. Submit the executed bid on the bid forms provided, signed and corporate sealed as applicable together with the required security in a closed opaque envelope, clearly identified with Bidders name, project name on the outside.
- 25.1.1.4. Improperly completed information, irregularities, in required enclosures may be cause to declare the bid informal.

25.2. Bid Signing

- 25.2.1. The bid form **Must** be signed and under seal (as applicable) by a duly authorized signing officer(s) in their normal signatures.

25.3. Contract Time

- 25.3.1. The bidder, in submitting an offer, agrees to achieve Substantial performance of the work by the date indicated in the contract documents. The Substantial Performance date in the agreement shall be as indicated on the cover sheet.

##3857 RECLADDING – TERENCE BAY ELEMENTARY

26. Offer Acceptance / Rejection

26.1. Duration of offer

26.1.1. Bids shall remain open to acceptance and shall be irrevocable for a period of ninety (90) days after the bid closing date.

26.2. Award/Selection/Acceptance of Offer

26.2.1. In the evaluation of a bid, HRSB will consider, but not be limited to, the following criteria:

26.2.1.1. Compliance with Bid requirements.

26.2.1.2. Bid price submitted.

26.2.1.3. The qualifications and experience of the bidder with similar projects in size and scope.

26.2.1.4. References.

26.2.1.5. Gantt chart (schedule of proposed scope of work for various disciplines).

26.2.1.6. Completion date.

26.2.2. The Owner's evaluation of any and all bid submission(s) will be final.

26.3. HRSB reserves the right to accept or reject any or all offers or to accept any offer deemed most satisfactory, HRSB reserves the right to waive any informality in any or all bids.

26.4. After acceptance HRSB will issue to the successful bidder, a written bid acceptance.

26.5. After acceptance by HRSB, the successful bidder shall be notified in writing of acceptance of the bid and will be issued an official purchase order.

27. Agreement

27.1. After acceptance by HRSB and the successful bidder will enter into a CCDC-2 –2008, standard form of contract for the execution of the work.

28. Post Bid Submissions

28.1. Provide after closing of bid period, but before award of Contract, when requested by HRSB, a copy of the following documents:

28.1.1. Current Certificate of Recognition or Letter of Good Standing:

28.1.1.1. Certificate of Recognition issued jointly by the Nova Scotia Department of Labour and an occupational health and safety organization approved by Nova Scotia Department of Labour, or a valid letter of Good Standing from an occupational health and safety organization approved by HRSB

##3857 RECLADDING – TERENCE BAY ELEMENTARY

indicating the Contractor is in the process of qualifying for the Certificate of Recognition. Contractor shall remain in good standing for the duration of the contract. In the event that any such certification during the term of the contract expires, the obligation remains with the contractor to provide the updated required certificates.

28.1.1.2. Worker's Compensation Coverage

28.1.1.2.1. Evidence of an account with the Workers' Compensation board, coverage under the Workers Compensation Act, R.S.N.S. and a clearance certificate indicating the bidder is in good standing and shall remain so for the duration of the contract. In the event that any such certification during the term of the contract expires, the obligation remains with the contractor to provide the updated required certificates.

28.1.1.3. Certificates of good standing with CRCA (Canadian Roofing Contractors Association) and RCANS (Roofing Contractors Association of Nova Scotia),

28.1.2. Submit Post-Bid Submissions requested by HRSB within forty-eight (48) hours of request in order to be eligible to receive award of contract.

28.1.3. Submit the following post award documents within ten (10) working days of notice of award:

28.1.3.1. Provide all required contract security and insurance documentation,

28.1.3.2. Schedule of Values,

28.1.3.3. Copy of safety plan,

28.1.3.4. Copy of Hot Work Permit system and procedures,

28.1.3.5. Shop drawings, as applicable, and

28.1.3.6. Applicable documentation as required by the Tender Documents.

28.1.4. All post bid submissions must be received by HRSB in the manner prescribed above, or prior to commencement of work and delivery of materials on-site, whichever occurs first.

29. Taxes

29.1. The General Conditions of the Contract state that the Contractor as of April 1, 1997 and thereafter, the Contractor is to pay all Harmonized Sales Tax.

- 29.2.** HRSB is not exempt for Harmonized Sales Tax (HST) purposes. As a result, the aggregate amount of the bid for contracts is subject to HST, however, **prices submitted shall not include HST.**
- 29.3.** The HST payable by the Board will be added as a separate item during the processing of progress payments and therefore **HST will not appear as a cost in the aggregate amount of the tender.**
- 29.4.** Bidders are advised that they may be eligible to claim an Input Tax Credit (ITC) for a portion of the HST paid in relation to the Contract requirement of the Government of Canada.
- 29.5.** Bidders are to note that prices indicated on the Bid Form and the appendices to the Bid Form shall not include Provincial Sales Taxes, the Federal Goods and Services Tax or the Harmonized Sales Tax.
- 29.6.** Exclude Harmonized Sales Tax in Tender Contract Price, unless requested to do otherwise.
- 29.7.** Refer to CCDC-2 - 2008 (Section 00 72 13) and Supplementary General Conditions (Section 00 73 00).

END OF SECTION 00 21 13

SECTION 00 41 13 - TENDER FORM

1. Salutation:

To: HALIFAX REGIONAL SCHOOL BOARD
33 SPECTACLE LAKE DRIVE, DARTMOUTH NS
Attn: JENNIFER KING, BUYER

For: #3857 RECLADDING – TERENCE BAY ELEMENTARY SITE

From: _____

Address: _____

E-Mail: _____

Phone: _____

Fax: _____

Person Signing for Firm: _____

Position: _____

2. Bidder Declares:

- 2.1. That this tender was made without collusion or fraud.
- 2.2. That the proposed work was carefully examined.
- 2.3. That the Bidder was familiar with local conditions.
- 2.4. That Contract Documents and Addenda were carefully examined.
- 2.5. That all the above were taken into consideration in preparation of this Tender.

3. Bidder Agrees:

- 3.1. To provide all necessary equipment, tools, labour, incidentals and other means of construction to do all the Work and furnish all the materials of the specified requirements which are necessary to complete the Work in accordance with the Contract and agrees to accept, therefore, as payment in full the Lump Sum Price stated in Subsection 6 hereunder.
- 3.2. Carefully examined the site of the work described herein; become familiar with local conditions and the character and the extent of the work; carefully examined every part of the proposed Contract and thoroughly understands its stipulations, requirements and provisions.
- 3.3. Determined the quality and quantity of materials required; investigated the location and determined the source of supply of the materials required; investigated labour conditions; and has arranged for the continuous prosecution of the work herein described

##3857 RECLADDING – TERENCE BAY ELEMENTARY

- 3.4. To be bound by the award of the contract and if awarded the contract on this bid to execute the required contract within ten (10) days after notice of award.
- 3.5. Noted that the Harmonized Sales Tax is excluded from his "Contract Price".
- 3.6. School/Work site access control: Contractor's employees shall always report to the main office of a school, indicate who they are and state their purpose on site prior to starting any work in the school. Contractor is not permitted to work on the school site without School Board's assigned representative on site unless authorized by School Board Operations representative. Typical hours of work are daylight hours. Working in occupied schools will be determined by the Operations representative. No work shall be conducted on weekends or holidays without specific approval of the Operations Representative.
- 3.7. Hours of work – All work shall be carried out during regular business hours unless otherwise indicated below or in writing by the Manager of Operations or designate. Hours of work shall comply with local ordinances and bylaws for each site.

4. Owner Agrees

- 4.1. To examine this bid and in consideration, therefore, the bidder hereby agrees not to revoke this bid:
 - 4.1.1. until some other bidder has entered into the contract with The School Board for the performance of the work and the supply of the materials specified in the notice inviting bids; or in the Information to Bidders, or
 - 4.1.2. until ninety (90) days after the time fixed in the Information to Bidders for receiving bids has expired,
 - 4.1.3. Whichever first occurs; provided, however, that the bidder may revoke this bid at any time before the time fixed in the Information to Bidders for receiving bids has expired upon receipt by the Board from the bidder of written notice of such revocation before said time has expired.
 - 4.1.4. The Bidder declares that he has obtained from the Subcontractors all Bid Security required to be provided by Subcontractors pursuant to the "Instructions to Bidders".

5. Contract Documents include:

- 5.1.1. Cover Page
- 5.1.2. Table of Contents – Section 00 00 01
- 5.1.3. Description of Work & List of Drawings – Section 00 00 15
- 5.1.4. List of Consultants – Section 00 05 00
- 5.1.5. Information for Bidders – Section 00 21 13
- 5.1.6. Tender Form – Section 00 41 13
- 5.1.7. Tender Price Amendment Form (if applicable) – Section 00 41 73
- 5.1.8. Agreement Between Owner and Contractor (CCDC 2 – 2008) – Section 00 52 00
- 5.1.9. Definitions (CCDC 2 – 2008) – Section 00 52 13
- 5.1.10. General Conditions of the Stipulated Contract Price (CCDC 2 -2008) – Section 00 72 13
- 5.1.11. Supplementary General Conditions – Section 00 73 00
- 5.1.12. HRSB General Terms & Conditions – Section 00 73 10
- 5.1.13. Specifications of Work (all applicable sections)
- 5.1.14. Drawing(s) – as applicable
- 5.1.15. Addendum/Addenda issued by HRSB.
- 5.1.16. Contract Sets (2)

6. Fee Submission - Contract Price:

6.1. The undersigned Bidder, having carefully read and examined the aforementioned Contract Documents prepared by the Consultant, for Halifax Regional School Board hereby accepts the same as part and parcel of the Contract herein referred to, and having carefully examined the locality and Site of Works and having full knowledge of the work required and of the materials to be furnished and used, does hereby Tender and offer to enter into a contract to perform and complete, the whole of the said works and provide all necessary labour, plant, tools, materials and equipment and pay all applicable taxes, as set forth and in strict accordance with the Specifications, Drawings and other Contract Documents and to do all therein called for on the terms and conditions and under the provisions therein set forth for the following:

6.2. LUMP SUM BID PRICE

_____ /100 Dollars (\$ _____) (HST Excluded)

Contract Price to be completed in written form on the lines provided above, with cents expressed as numerical fraction of a dollar. Contract price to be completed in numerical form on the line bounded by parenthesis above, with cents expressed as a decimal of a dollar. WHERE THERE IS A CONFLICT, WRITTEN WORD WILL GOVERN.

##3857 RECLADDING – TERENCE BAY ELEMENTARY

6.3. Breakout Prices: Breakout prices requested in the Tender Document, as detailed below, **SHALL BE INCLUDED IN THE LUMP SUM TENDER PRICE** above (6.1 - Contract Price) and deleted only on the instruction at the sole discretion of the Owner, for which a credit will be offered by the Contractor, equal to the breakout pricing detailed below (price excludes HST):

Item No.	Description	Unit of Measurement	Credit Amount
1.	_____	_____	\$ _____
2.	_____	_____	\$ _____
3.	_____	_____	\$ _____
4.	_____	_____	\$ _____
5.	_____	_____	\$ _____

Total Credit Amount for ALL Breakout Items:

_____ /100 Dollars (\$ _____) (HST Excluded)

Separate Prices: Separate prices requested in the Tender Document, as detailed below **SHALL NOT BE INCLUDED IN THE LUMP SUM TENDER PRICE** above (6.1 - Contract Price) and added only on the instruction and at the sole discretion of the Owner, for which the contract will be adjusted, equal to the separate pricing detailed below (price excludes HST):

Listing of Separate Price Details Requested by Board:

Item No.	Description	Unit of Measurement	Unit Price
6.	_____	_____	\$ _____
7.	_____	_____	\$ _____
8.	_____	_____	\$ _____
9.	_____	_____	\$ _____
10.	_____	_____	\$ _____

7. Completion Time:

7.1. Bidder agrees to be substantially complete as follows:

7.1.1.1. **OCTOBER 31, 2016**

7.1.1.2. The undersigned Bidder agrees if awarded the Contract on this Bid to achieve the Substantial Completion Date providing the contract is awarded within ten (10) business days of tender closing time.

7.2. Detailed breakdown of overall project specific phases (schedule of proposed scope of work for various disciplines) written and/or Gant Chart to be provided with bid documents or within five (5) business days of tender award.

8. Addenda Acknowledgement

I/We have received and noted the following addenda for Tender #3857 RECLADDING - TERENCE BAY ELEMENTARY SITE:

Addendum #	Dated	# of Pages
_____	_____	_____
_____	_____	_____
_____	_____	_____
_____	_____	_____
_____	_____	_____

9. Supporting Information

9.1. References: (Minimum of three)

Bidder to furnish particulars of at least three (3) similar contracts successfully completed or currently being carried to completion. The projects quoted should preferably be approximate in nature to the work now tendered for and be of comparable or greater size. References are to be submitted with the bid prior to closing date and time.

Contact Name & Phone #	Date	Contract Value
_____	From _____ to _____	\$ _____
_____	From _____ to _____	\$ _____
_____	From _____ to _____	\$ _____
_____	From _____ to _____	\$ _____

##3857 RECLADDING – TERENCE BAY ELEMENTARY

9.2. Bid submission to include a minimum of two letters of endorsement from clients commenting upon the contractor’s ability to deliver quality projects, similar in scope and size, which met schedule and budget.

10. Proof Of Competency Of Bidder

10.1. Any bidder may be required to furnish evidence satisfactory to the Owner that he and his proposed sub-contractors have sufficient means and experience in the types of work called for to assure completion of the Contract in a satisfactory manner.

10.1.1. The Bidder acknowledges, as part of their bid submission, their responsibility and contract obligations to ensure that the proposed sub-contractors will fully perform the project requirements and meet the timings as detailed in this tender call.

10.2. **Sub-Contractors:** The Bidder to provide the name and address of each major sub-contractor used in making up this tender. This list of sub-contractors is to be submitted with the bid prior to closing date and time. Only one sub-contractor shall be named for each part of the work to be sublet.

<u>Subcontractor/Suppliers/Manufacturers</u>	<u>Service/Material</u>
Site Works	
Electrical	
Mechanical	
Roof	

10.2.1. **Project Personnel:** The Bidder to include below, the names, qualifications and previous experience of those people who will be directly involved with the project. The names shall, for example, include foremen, superintendent, project engineer and/or project manager, labourers and trade staff. This list of personnel is to be submitted with the bid prior to closing date and time.

Name	Position	Qualifications/Experience

Signature * The undersigned Bidder declares that this bid is made without connection with any other person(s) submitting bids for the same work and is in all respects fair and without collusion or fraud.

SIGNATURE:

SIGNED AND DELIVERED
in the presence of:

Witness

CONTRACTOR

Company name

Signature of Signing Officer

Name and Title (printed)

HRSB is directly responsible for the safety of its students and staff. Should contractors be required to work in or on school property while children are present, it is a MANDATORY SCHOOL BOARD REQUIREMENT that contractors assign the work to employees and/or sub-contractors who DO NOT have a CRIMINAL RECORD and who ARE NOT LISTED ON THE CHILD ABUSE REGISTRY. Failure to comply with this requirement may result in immediate contract termination.

By checking the "Agreed" box you are confirming that you understand and will abide by this mandatory School Board requirement.

Agreed

****Note: Bids submitted **Must** be signed by a duly authorized officer or agent.***

END OF SECTION 00 41 13

##3857 RECLADDING – TERENCE BAY ELEMENTARY

SECTION 00 41 73 - TENDER AMENDMENT FORM

#3857 RECLADDING – TERENCE BAY ELEMENTARY

Note: to be completed and forwarded for each Bid Price adjustment prior to bid closing time and date as detailed on the Cover Sheet of the tender document and related Addendum.

Lump Sum Price Adjustment – Section 00 41 13 Tender form, Article 6.1.1 Contract Price

Increase Bid by		Decrease Bid By	
Amount (excluding HST)	\$	Amount (excluding HST)	\$
HST	\$	HST	\$
Total Amount (including HST)	\$	Total Amount (including HST)	\$

It is the Bidder's responsibility to ensure the table above is legible

Attachments included: no yes (✓ one)

If **yes** above, check ✓ and complete information regarding attachments

Revised Bid Form: Dated _____ # of pages _____

Other, Specify _____

Dated _____ # of pages _____

Total number of pages (including this form) _____

Submitted by:

Company Name (please print as it appears on original tender envelope)

Authorized Bidder's Name (please print as it appears on Bid Form)

Authorized Bidder's Signature

END OF SECTION 00 41 73

##3857 RECLADDING – TERENCE BAY ELEMENTARY

***SECTION 00 52 00 - AGREEMENT BETWEEN OWNER AND CONTRACTOR
CCDC 2 – 2008***

(a copy of Section 00 52 00, Standard Construction Contract CCDC 2 – 2008 (5 pages) is available upon request, otherwise, will form part of the contract sets to the successful bidder)

END OF SECTION 00 52 00

##3857 RECLADDING – TERENCE BAY ELEMENTARY

***SECTION 00 52 13 - DEFINITIONS
CCDC 2 - 2008***

(A copy of section 00 52 13, Standard Construction Contract CCDC 2 – 2008 (2 pages) is available upon request, otherwise, will form part of the contract sets to the successful bidder)

END OF SECTION 00 52 13

##3857 RECLADDING – TERENCE BAY ELEMENTARY

***SECTION 00 72 13 - GENERAL CONDITIONS
OF THE STIPULATED PRICE CONTRACT
CCDC 2 - 2008***

(A copy of section 00 72 13, Standard Construction Contract CCDC 2 – 2008 (23 pages) is available upon request, otherwise, will form part of the contract sets to the successful bidder)

END OF SECTION 00 72 13

##3857 RECLADDING – TERENCE BAY ELEMENTARY

SECTION 00 73 00 - SUPPLEMENTARY GENERAL CONDITIONS CCDC2 – 2008

The Canadian Standard Construction Document for Stipulated Price Contract (CCDC 2, 2008 version), Definitions and General Conditions governing same, shall be used by the project. The following Supplementary General Conditions are intended to supplement or amend the General Conditions, and where conflicts occur, the Supplementary Conditions shall take precedence.

Where a General Condition or paragraph of the General Conditions of the Stipulated Price Contract is deleted by these Supplementary Conditions, the numbering of the remaining General Conditions or paragraphs shall remain unchanged, and the numbering of the deleted item will be retained, unused.

ARTICLE A-5 PAYMENT

Delete paragraph 5.1 in its entirety and insert:

5.1 "Subject to applicable legislation and the provisions of the Contract Documents, and in accordance with legislation and statutory regulations respecting holdback percentages and, where such legislation or regulations do not exist or apply, subject to a holdback of ten percent (10%) including the HST (Harmonized Sales Tax), the Owner shall:"

- .1 Make progress payments to the Contractor on account of the Contract Price (work performed) when due in the amount certified by the Consultant together with Value Added Taxes as may be applicable to such payments, and
- .2 Upon Substantial Performance of the Work as certified by the Consultant, pay to the Contractor the unpaid balance of monies then due, excepting that amounts as certified by the Consultant to rectify deficiency items, or incomplete portions of individual work items may be retained by the Owner pending Total Performance of the work or other authorization for the release by the Consultant, and
- .3 Upon Total performance of the Work as certified by the Consultant pay to the contractor the unpaid balance of monies due together with such Value Added Taxes as may be applicable to such payment.

Change 5.3.1 (1) to read: "1% per annum above the prime rate."

Delete 5.3.2 (2) in its entirety.

DEFINITIONS

Add subparagraph 19a to definitions:

19a. Submittals

Submittals are documents or items required by the Contract Documents to be provided by the Contractor, such as:

- 1 Shop Drawings, samples, models, mock-ups to include details or characteristics, before the portion of the Work that they represent can be incorporated into the Work; and
- 2 As-built drawings and manuals to provide instructions to the operation and maintenance of the Work.

GC 1.1 CONTRACT DOCUMENTS

Add to the end of subparagraph 1.1.2.2:

1.1.2.2 Except where the Consultant shall be indemnified as a third party beneficiary as provided in subparagraphs 9.2.7.4, 9.5.3.4 and in 12.1.3.

Add subparagraph 1.1.7.5:

1.1.7.5 Should conflicts occur between Contract Documents and any work is done without consulting the Consultant for his decision, the Contractor shall assume full responsibility.

Add subparagraph to 1.1.7.6:

1.1.7.6 In case of discrepancies, noted materials and annotations shall take precedence over graphic indications in the Contract Documents.

Delete paragraph 1.18 in its entirety and insert:

1.18 "The Contractor will be provided with up to a maximum of ten (10) copies, without charge, of the Contract Documents or parts thereof for the performance of the work. Extra copies may be obtained for cost of printing and mailing."

GC 2.4 DEFECTIVE WORK

Add new subparagraphs 2.4.1.1 and 2.4.1.2:

2.4.1.1 The Contractor shall rectify, in a manner acceptable to the Owner and the Consultant, all defective work and deficiencies throughout the Work, whether or not they are specifically identified by the Consultant.

2.4.1.2 The Contractor shall prioritize the correction of any defective work which, in the sole discretion of the Owner, adversely affects the day to day operation of the Owner.

GC 3.1 CONTROL OF THE WORK

Add new paragraph 3.1.3:

3.1.3 Prior to commencing individual procurement, fabrication, and construction activities, the Contractor shall verify, at the Place of work, all relevant measurements and levels necessary for proper and complete fabrication, assembly and installation of the Work and shall further carefully compare such field measurements and conditions with the requirements of the Contract Documents. Where dimensions are not included or contradictions exist, or exact locations are not apparent, the Contractor shall immediately notify the Consultant before proceeding with any part of the affected work.

GC 3.4 DOCUMENT REVIEW

Delete paragraph 3.4.1 in its entirety and substitute new paragraph:

3.4.1 The Contractor shall review the Contract Documents and shall report promptly to the Consultant and error, inconsistency or omission the Contractor may discover. Except for its obligation to make such review and report the result, the Contractor does not assume any responsibility to the Owner or to the Consultant for the accuracy of the Contract Documents. The Contractor shall not be liable for damage or costs resulting from such errors, inconsistencies, or omissions in the Contract Documents, which the Contractor could not have reasonably have discovered. If the Contractor does discover any error, inconsistency, or omission in the Contract Documents the Contractor shall not proceed with the work affected until the Contractor has received corrected or missing information from the Consultant.

GC 3.7 SUBCONTRACTORS AND SUPPLIERS

Add the following paragraph 3.7.7:

- 3.7.7 A copy of the agreement between Contractor and any subcontractor(s) shall be provided to the Consultant if so requested.

GC 3.8 LABOUR AND PRODUCTS

Add the following paragraph 3.8.4:

- 3.8.4 The Contractor is responsible for the safe on-site storage of Products and their protection (including Products supplied by the Owner and other contractors to be installed under the Contract) in such ways as to avoid dangerous conditions or contamination to the Products or other persons or property and in locations at the Place of the Work to the satisfaction of the Owner and the Consultant. The Owner shall provide all relevant information on the Products to be supplied by the Owner.

GC 3.10 SHOP DRAWINGS

Add the words "AND OTHER SUBMITTALS" to the Title after SHOP DRAWINGS in GC 3.10.

Add "and submittals" after the words "Shop Drawings" in paragraphs 3.10.1, 3.10.2, 3.10.4, 3.10.7, 3.10.8, 3.10.8.2, 3.10.9, 3.10.10, 3.10.11 and 3.10.12.

Delete 3.10.3 in its entirety and substitute new paragraph:

- 3.10.3 Prior to the first application for payment, the Contractor and the Consultant shall jointly prepare a schedule of the dates for submission and return of Shop Drawings and any Submittals.

Add the following subparagraph 3.10.6.1:

- 3.10.6.1 The following paragraph shall apply to each shop drawing and submittals reviewed in connection with the project. This review shall not mean that the Consultant approved the detailed design inherent in the shop drawings, responsibility for which shall remain with the Contractor submitting same. The Contractor is responsible for information that pertains solely to fabricated processes or to techniques of construction and installation, and for coordination of the work of all sub trades.

Delete and insert the words in paragraph 3.10.12

3.10.12 “with reasonable promptness so as to cause no delay in the performance of the Work”
and replace with “within ten (10) working days or such longer period as may be reasonably required”

PART 3 EXECUTION OF THE WORK

Add new GC 3.14 as follows:

GC 3.14 CONTRACTOR RESPONSIBILITY FOR WATER TIGHTNESS

GC 3.14.1 The drawings and specifications are not intended to depict each and every condition or detail of construction. As the knowledgeable party in the field, the contractor is in the best position to verify that all construction is completed in a manner which will provide a watertight structure. The contractor has the sole responsibility for ensuring the watertight integrity of the structure.

Add new GC 3.15 as follows:

GC 3.15 PERFORMANCE BY CONTRACTOR

GC 3.15.1 In performing its services and obligations under the Contract, the Contractor shall exercise a standard of care, skill and diligence that would normally be provided by an experienced and prudent contractor supplying similar services for similar projects. The Contractor acknowledges and agrees that throughout the Contract, the Contractor’s obligations, duties and responsibilities shall be interpreted in accordance with this standard. The Contractor shall exercise the same standard of due care and diligence in respect of any products, personnel, or procedures which it may recommend to the Owner.

The Contractor further represents, covenants and warrants to the Owner that:

1. The personnel it assigns to the Project are appropriately experienced;
2. It has sufficient staff of qualified and competent personnel to replace its designated supervisor and project manager, subject to the Owner’s approval, in the event of death, incapacity, removal or resignation.

GC 4.1 CASH ALLOWANCES

Delete paragraph 4.1.4 in its entirety and substitute:

4.1.4 Where cost under a cash allowance exceed the amount of the allowances, unexpended amounts from other cash allowances shall be reallocated at the *Consultant's* direction to cover the shortfall.

Delete paragraph 4.1.5 in its entirety and substitute:

4.1.5 The net amount of any unexpended cash allowances, after providing for any reallocations as contemplated in paragraph 4.1.4, shall be deducted from the Contract Price by Change Order.

Delete paragraph 4.1.7 in its entirety and substitute:

4.1.7 At the commencement of the work, the Contractor shall prepare for the review and acceptance of the Owner and the Consultant, a schedule indicating the times, within the construction schedule referred to in GC 3.5, that items call for under cash allowances and items that are specified to be Owner purchased and Contractor installed or hooked up are required at the site to avoid delaying the progress of the Work.

Add new paragraph 4.1.8:

4.1.8 The *Owner* reserves the right to call, or to have the Contractor call, for competitive bids for portions of the Work, to be paid for from cash allowances.

GC 5.1 FINANCING INFORMATION REQUIRED OF THE OWNER

Delete section GC 5.1 in its entirety.

GC 5.2 APPLICATION FOR PROGRESS PAYMENT

Add the following at the end of paragraph 5.2.2:

5.2.2 Such applications shall be accompanied by one or more of the following documents: a Statutory Declaration Waiver of Lien or receipt stating that the holdback monies claimed have been paid to the particular party or parties so named or referred to in the Declaration. Form of Statutory Declaration shall meet the approval of the Consultant.

Add the following paragraph 5.2.8:

5.2.8 The reference to payment for products delivered to the place of work in Article 5.2.7 shall not be construed as covering day-to-day financing of the project. Products delivered to the place of work shall be construed to mean major items of equipment or quantities of items that are essential for the expedient conduct of the work.

GC 5.3 PROGRESS PAYMENT

Supplement paragraph 5.3.1 by adding the following:

5.3.1 A holdback percentage of ten (10) percent (%) shall apply to progress payments. The sworn statement by the Contractor for release of holdback monies shall be in the form of a Statutory Declaration meeting the approval of the Consultant. Amounts as certified by the Consultant to rectify deficiency items, or incomplete portions of individual work items, may be retained by the Owner after Substantial Performance has been obtained, pending Total Performance of the work or other authorization for release by the Consultant.

Amend subparagraph 5.3.1.3 as follows:

5.3.1.3 Delete "20" and replace with "30."

GC 5.4 SUBSTANTIAL PERFORMANCE OF THE WORK

Add the following paragraph 5.4.4:

5.4.4 Before the Contractor submits his application for Substantial Performance of the Work, all Operations and Maintenance Manual materials shall be submitted in accordance with the Contract Documents. The Certificate of Substantial Performance will not be issued until this requirement is met.

GC 5.5 PAYMENT OF HOLDBACK UPON SUBSTANTIAL PERFORMANCE OF WORK

Add the following subparagraphs 5.5.1.3 and 5.5.1.4:

5.5.1.3 Submit a certificate from barrister stating that there are no Builders' Liens filed relating to the Contract Works.

5.5.1.4 Submit a clearance letter from the Workers' Compensation Board.

##3857 RECLADDING – TERENCE BAY ELEMENTARY

GC 5.7 FINAL PAYMENT

Add the following subparagraphs 5.7.1.1, 5.7.1.2, 5.7.1.3, 5.7.1.4 and 5.7.1.5:

5.7.1.1 Contractor's application for final payment is considered to be valid when the following have been performed:

1. Work has been completed and inspected for compliance with Contract Documents, and the Consultant is satisfied that all the requirements of the Contract have been fulfilled by the Contractor.
2. Defects have been corrected and deficiencies have been completed.
3. Equipment and systems have been tested, adjusted and balanced and are fully operational, and written reports as outlined in the Contract Documents have been provided to the Consultant.
4. Certificates required by Utility companies, manufacturer's representative and inspectors have been submitted.
5. Spare parts, maintenance materials, warranties and bonds have been provided.

5.7.1.2 If Work is deemed incomplete by Consultant, complete outstanding items and request re-inspection.

5.7.1.3 If in opinion of the Consultant, it is not expedient to correct defective work or Work is not performed in accordance with the requirements of the Contract, the Owner may deduct from Contract Price difference in value between work performed and that called for by Contract Documents, amount of which shall be determined by the Consultant.

5.7.1.4 If, within sixty (60) days after the issue by the Consultant of the Certificate of the Substantial Performance, the Contractor has not corrected all the deficiencies, the Owner will retain sufficient money to cover the cost of completing said deficiencies, as determined by the Consultant, in addition to holding monies retained in accordance with the Contract and subject to the provisions of the Builders' lien legislation of Nova Scotia.

5.7.1.5 Neither the final certificate nor the payment thereunder, nor any provision in the Contract Documents shall relieve the Contractor from responsibility for faulty material or workmanship which shall appear within a period of one (1) year from the date of Substantial Performance of the Work and he shall remedy any defects due thereto and pay for any damage to other Work resulting therefrom which shall appear within such period of one year. The Owner shall give notice of observed defects promptly. This article shall not be deemed to restrict any liability of the Contractor arising out of any law in force in the Province of Nova Scotia.

GC 6.2 CHANGE ORDER

Add the following paragraphs 6.2.3, 6.2.4, 6.2.5, 6.2.5, 6.2.6 and 6.2.7:

- 6.2.3 All contemplated changes in the work shall be issued by the Consultant on a "Contemplated Change Order" form.
- 6.2.4 For lump sum pricing, the Contractor shall, upon receipt of the Contemplated Change Order, submit to the Consultant for approval within seven (7) days, a quotation for changes in the work.
- 6.2.5 Quotation for changes shall be priced in sufficient detail (GC6.6 applies).
- 6.2.6 Consultant shall, within five (5) working days, notify the Contractor whether estimates are accepted by Owner or further information required. Acceptance of Owner shall be indicated by writing, and a signed copy of form (Change Order) returned to Contractor.
- 6.2.7 Contractor shall take reasonable measures to stop work or minimize the work in areas affected by or related to the contemplated changes.

GC 6.4 CONCEALED OR UNKNOWN CONDITIONS

Add new paragraph 6.4.5:

6.4.5 The *Contractor* confirms that, prior to bidding the *Project*, it carefully investigated the Place of the Work and applied to that investigation the degree of care and skill described in paragraph 3.15.1, given the amount of time provided between the issue of the bid documents and the actual closing of bids, the degree of access provided to the Contractor prior to submission of bid, and the sufficiency and completeness of the information provided by the Owner. The Contractor is not entitled to compensation or to an extension of the Contract Time for which could reasonably have been ascertained by the Contractor by such careful investigation undertaken prior to the submission of the bid.

GC 6.5 DELAYS

Delete the period at the end of paragraph 6.5.1 and substitute the following words:

6.5.1 “, but excluding any consequential, indirect or special damages.”

Add new paragraph 6.5.6:

6.5.6 If the Contractor is delayed in the performance of the Work by any act or omission of the Contractor or anyone employed or engaged by the Contractor directly or indirectly, or by any cause within the Contractor’s control, then the Contract Time shall be extended for such reasonable time as the Consultant may decide in consultation with the Contractor. The Owner shall be reimbursed by the Contractor for all reasonable costs incurred by the Owner as the result of such delay, including all services required by the Owner from the Consultant as a result of such delay by the Contractor and, in particular, the cost of the Consultant’s services during the period between the date of Substantial Performance of the Work stated in Article A-1 herein as the same may be extended through the provisions of these General Conditions and any later, actual date of Substantial Performance of the Work achieved by the Contractor.

Add new paragraph 6.5.7:

6.5.7 If the Contractor is delayed in the completion of the Work by any act or neglect of: The School Board, any employee or either any other Contractor employed by The School Board, changes ordered in the Work, strikes, lockouts, fire, unusual delay by common carriers, unavoidable casualties, any other cause of any kind whatsoever beyond the Contractor’s control or by any cause within the Contractor’s control which the Consultant shall decide as justifying the delay, then the time of completion shall be extended for such reasonable time as the Consultant may decide.

Add new paragraph 6.5.8:

6.5.8 No such extension shall be made for delay occurring more than seven (7) days before claim therefore is made in writing to the Consultant, provided however that in the case of a continuing cause of delay, only one (1) claim shall be necessary.

Add new paragraph 6.5.9:

6.5.9 If no schedule is made, no claim for delay shall be allowed on account of failure to furnish such schedule until two (2) weeks after demand for such schedule and not then unless such claim be reasonable.

Add new paragraph 6.5.10:

6.5.10 The Consultant shall not, except by written notice to the Contractor, stop or delay any part of the main Contract Work pending decisions or proposed changes.

GC6.6 CLAIMS FOR A CHANGE IN CONTRACT PRICE

Amend paragraph 6.6.5 as follows:

6.6.5 Add the words “as noted in paragraph 6.6.3” after the words “of the claim” and add the words “and the consultant”, at the end.

GC 6.7 VALUATION OF CHANGES

Add the following Header and paragraphs 6.7.1, 6.7.2, 6.7.3 and 6.7.4 in their entirety:

GC 6.7 VALUATION OF CHANGES

- 6.7.1 The value of any change shall be determined in one or more of the following way as determined by the Consultant:
- (a) By estimate and acceptance in a lump sum, submitted with sub-contractors' and suppliers' signed quotations and breakdown estimates including itemized material and labour lists.
For changes where the individual trade cost is anticipated to be less than \$1000, the requirement for the detailed cost breakdown may be waived, but individual trade quotation must be supplied.
 - (b) By unit prices agreed upon or as listed in the contract.
 - (c) Cost of work and percentage or by cost and fixed fee.

6.7.2 In cases of additional work to be paid for under method "c", the Contractor shall keep and present in such form as the Consultant may direct, a correct account of the net cost of labour and materials, together with vouchers. In any case, the Consultant shall certify to the amount due to the Contractor including the profit and overhead. Pending final determination of value, payments on account of changes shall be made on the Consultant's certificate.

6.7.3 In determination of method ".1(a) or ".1(c) above, the labour costs to be calculated by the actual estimated hours at an hourly rate determined as follows:

The hourly labour rate to be total payroll costs including hourly wage, statutory contributions to UIC, WCB, CPP, Training Funds, Health Benefits and other applicable labour burdens paid directly by the employer such as vacation pay, holiday pay, pension plan etc.

The School Board reserves the right to verify the payroll cost by independent audit.

To the total payroll cost the following percentage factors will be recognized.

- small tools/expenditures 5% (on payroll costs)
- site supervision 5% (on payroll costs)

(d) In determination of methods ".1(a)" and ".1(c)" above, the material costs to be calculated as follows:

Contractors net costs, including contractor discounts from suppliers, FOB the project site plus applicable taxes.

(e) In determination of methods ".1(a)" and ".1(c)" above, equipment rental costs for major pieces of equipment required will be at local industry rates.

(f) In determination of methods “.1(a)” and “.1(c)” above, overhead and fees shall be calculated as follows:

The cost of any authorized change shall be determined by the net total of labour and material or equipment as outlined in “.3(a)”, “.3(b)” and “.3(c)” above on which the percentage markup shall be determined as follows:

For Extras Up to \$5,000:

Sub- Contractors Own Work	- Overhead & Fee – 15% total
General Contractors Own Work	- Overhead & Fee – 15% total
General Contractors on Sub Contractors work (no percentage markup shall be applied to deductions)	- 10% total

For Extras Above \$5,000:

Sub Contractors Own Work	- Overhead & Fee – 10% total
General Contractors Own Work	- Overhead & Fee – 10% total
General Contractors on sub contractor’s work (no percentage markup shall be applied to deductions)	– 8% total

6.7.4 Submit to the Consultant and The School Boards representative detailed breakdown of the hourly labour rate as defined in paragraph “.3(a)”.

GC 8.2 NEGOTIATION, MEDIATION, AND ARBITRATION

Add the following paragraphs 8.2.9, 8.2.10, 8.2.11, 8.2.12, 8.2.13, 8.2.14, and 8.3:

8.2.9 Within five days of receipt of the notice of arbitration by the responding party under paragraph 8.2.6, the Owner and the Contractor shall give the Consultant a written notice containing:

- a) a copy of the notice of arbitration;
- b) a copy of supplementary conditions 8.2.9 to 8.2.14 of this contract, and;
- c) any claims or issues which the Contractor or the Owner, as the case may be, wishes to raise in relation to the Consultant arising out of the issues in dispute in the arbitration.

8.2.10 The Owner and the Contractor agree that the Consultant may elect, within ten days of receipt of the notice under paragraph 8.2.9, to become a full party to the arbitration under paragraph 8.2.6 if the Consultant:

- a) has a vested or contingent financial interest in the outcome of the arbitration;

- b) gives the notice of election to the Owner and the Contractor before the arbitrator is appointed;
- c) agrees to be a party to the arbitration within the meaning of the rules referred to in paragraph 8.2.6, and;
- d) agrees to be bound by the arbitral award made in the arbitration.

8.2.11 If an election is made under paragraph 8.2.10, the Consultant may participate in the appointment of the arbitrator and, notwithstanding the rules referred to in paragraph 8.2.6, the time period for reaching agreement on the appointment of the arbitrator shall begin to run from the date the respondent receives a copy of the notice of arbitration.

8.2.12 The arbitrator in the arbitration in which the Consultant has elected under paragraph 8.2.10 to become a full party may:

- a) on application of the Owner or the Contractor, determine whether the Consultant has satisfies the requirements of paragraph 8.2.10, and;
- b) make any procedural order considered necessary to facilitate the addition of the Consultant as a party to the arbitration.

8.2.13 The provisions of paragraph 8.2.9 shall apply mutatis mutandis to written notice to be given by the Consultant to any sub-consultant.

8.2.14 In the event of notice of arbitration given by the Consultant to a sub-consultant, the sub-consultant is not entitled to any election with respect to the proceeding as outlined in 8.2.10, and is deemed to be bound by the arbitration proceeding.

8.3 An application for arbitration shall be accompanied by security in the amount of \$1000 to apply to the cost of arbitration. Any claims of excess costs must be submitted in writing to the Consultant within two weeks of completion or alleged completion of the work. No claims shall be accepted after this date and, also, no claims shall be accepted for disputed work unless the Consultant has been notified as specified.

GC 9.1 PROTECTION OF WORK AND PROPERTY

Delete subparagraph 9.1.1.1 in its entirety and substitute the following new paragraph 9.1.1.1:

9.1.1.1 errors in the Contract Documents which the Contractor could not have discovered applying the standard of care described in paragraph 3.15.1.

Delete paragraph 9.1.2 in its entirety and substitute the following new paragraph 9.1.2:

9.12 Before commencing any Work, the Contractor shall determine the locations of all underground utilities and structures indicated in the Contract Documents, or that are discoverable by applying to an Inspection of the Place of Work exercising the degree of care and skill described in paragraph 3.15.1.

GC 9.2 TOXIC AND HAZARDOUS SUBSTANCES

Add in paragraph 9.2.6 after the word “responsible”, the following new words:

9.2.6 Or whether any toxic or hazardous substances or materials already at the Place of Work (and which were then harmless or stored, contained or otherwise dealt with in accordance with legal and regulatory requirements) were dealt with by the Contractor or anyone for whom the Contractor is responsible in a manner which does not comply with legal and regulatory requirements, or which threatens human health and safety or the environment, or material damage to the property of the Owner and others,

Add in subparagraph 9.2.7.4:

9.2.7.4 “and the Consultant” after “Contractor”:

Add in paragraph 9.2.8 after the word “responsible”, the following new words:

9.2.8 or that any toxic or hazardous substances or materials already at the Place of the Work (and which were then harmless or stored, contained or otherwise dealt with in accordance with legal and regulatory requirements) were dealt with by the Contractor or anyone for whom the Contractor is responsible in a manner which does not comply with legal and regulatory requirement, or which threatens, humane health and safety or the environment, or material damage to the property of the Owner or others.

GC 9.5 MOULD

Add in subparagraph 9.5.3.4:

9.5.3.4 “and the Consultant” after “Contractor”

GC 10.1 TAXES AND DUTIES

Add the following paragraph 10.1.3:

10.1.3 The Contractor shall indicate on each application for payment as a separate amount, the appropriate Harmonized Sales Tax the Owner is legally obliged to pay. This amount will be paid to the Contractor in addition to the amount certified for payment under the Contract.

GC 10.2 LAWS, NOTICES, PERMITS AND FEES

Delete from the first line of paragraph 10.2.5 the word, “The” and substitute the words:

10.2.5 “Subject to paragraph 3.15.1, the”

GC 10.4 WORKERS' COMPENSATION

Add the following paragraphs 10.4.3, 10.4.4, and 10.4.5:

10.4.3 The contractor is referred to regulations, as applicable, under the Worker's Compensation Act of Nova Scotia.

10.4.4 Registration with Worker’s Compensation Board shall be continuous during the contract. Should registrations be scheduled to expire during the contract period, the Contractor shall submit a copy of registration renewal one month prior to the expiration of the current certificate.

10.4.5 The Contractor shall furnish evidence of coverage under the Worker’s Compensation Act, R.S.N.S. and a clearance Certificate providing proof of registration with Worker’s Compensation Board prior to commencement of work. (A photocopy of the Contractors registration certificate is acceptable proof). On-going proof of good standing with the Worker’s Compensation Board during the term of the contract is required.

GC 11.1 INSURANCE

Delete sentences and replace with the following in subparagraph 11.1.1.1:

- 11.1.1.1 "General liability insurance shall be maintained from the commencement of the work until one year from the date of Substantial Performance of the Work. Liability coverage shall be provided for completed operations hazards from the date of Substantial Performance of the Work, as set out in the certificate of Substantial Performance of the Work, on an ongoing basis for a period of 6 years following the Substantial Performance of the Work" **and replace with:** " General Liability Insurance or Wrap- Up Liability Insurance, (as detailed in the Information to Tenders section under "Insurance Requirements"), shall be maintained from the commencement of the work until final completion and acceptance of the work including the making good of faulty work or materials, except that coverage of completed operations liability shall in any event be maintained for twelve (12) months from date of Substantial Performance of the work as certified from the Consultant, and approved by the Owner".

Add the following subparagraphs 11.1.1.1.1, 11.1.1.1.2, and 11.1.1.2.1:

- 11.1.1.1.1 The general liability insurance to be maintained by the Contractor shall include Commercial General Liability Insurance covering Premises and Operations Liability, elevators, board form property damage, board from automobile, owners and contractors protective, blanket contractual, personal injury, completed operations liability contingent employers liability, cross liability clause, non-owned automobile liability, and a 30 day notice of cancellation clause.
- 11.1.1.1.2 All liability insurance policies shall be written in such terms as will fully protect the Contractor and
The School Board as an additional named insured.
- 11.1.1.2.1 Liability coverage of not less than two million dollars (\$2,000,000) is required with regard to operations of owned automobiles.

Delete subparagraph 11.1.1.4 in its entirety and insert the following subparagraphs:

- 11.1.1.4 Broad Form (All Risks) Builders Risk Coverage - Prior to the commencement of any Work the Contractor shall maintain and pay for Broad Form (All Risks) Builders Risk Coverage in the joint names of The School Board and the Contractor totalling not less than one hundred percent (100%) of the total value of the Work done and materials delivered on the site (contract value), so that any loss under such policies of insurance will be payable to The School Board and the Contractor as their respective interests appear. The Builders
##3857 RECLADDING – TERENCE BAY ELEMENTARY

Risk Insurance shall include all materials related to the work while in transit or at other locations.

- 11.1.1.4.1 Should a loss be sustained under the Builders Risk Coverage, the Contractor shall act on behalf of The School Board and Contractor for the purpose of adjusting the amount of such loss with the insurance companies. As soon as such adjustment has been satisfactorily completed, the Contractor shall proceed to repair the damage and complete the Work and shall be entitled to receive from The School Board in addition to any sum due under the Contract, the amount at which The School Board interest has been appraised in the adjustment made with the insurance companies as referred to above, said amount to be paid to the Contractor as the Work of restoration proceeds. Any loss or damage which may occur shall not affect the rights and obligations of either party under the Contract except as aforesaid and except that the Contractor shall be entitled to a reasonable extension of time for the performance of the Work, as The School Board may decide.
- 11.1.1.4.2 Upon approval by The School Board of the Substantial Performance certificate issued by the Consultant, the Contractor's obligation to maintain Builder Risk Insurance shall cease and The School Board shall assume full responsibility for insuring the whole of the Work against loss or damage.
- 11.1.1.4.3 "Broad form" property insurance in the joint names of the *Contractor*, the *Owner* and the *Consultant*. The policy shall include as insureds all *Subcontractors* The Broad form" property insurance shall be provided from the date of commencement of the *Work* until the earliest of:
- 11.1.4.3.1 Ten (10) Calendar days after the date of *Substantial Performance of the Work*;
 - 11.1.4.3.2 on the commencement of use or occupancy of any part or section of the *Work* unless such use or occupancy is for construction purposes, habitational, office, banking, convenience store under 465 square meter in area, or parking purposes, or for the installation, testing and commissioning or equipment forming part of the *Work*; and
 - 11.1.4.3.3 when left unattended for more than thirty (30) consecutive calendar days or when construction activity has ceased for more than thirty (30) consecutive calendar days.

Paragraph 11.1.2 is clarified as follows:

11.1.2 Submit Certified true copies of each insurance policy to the Owner's Contract Authority within seven (7) working days after notification of award or in any event prior to payment of the first progress claim. Such copies shall be exclusive of information pertaining to premium or premium bases used by the insurer to determine the cost of the insurance. Prior to the commencement of any work, the Contractor shall file with the Owner a certified copy of each insurance policy and certificate required.

Delete 11.1.5 in its entirety and replace with the following:

11.1.5 Insurance contracts shall be procured from and the premiums paid to a resident agent of an insurance Company licensed to underwrite insurance in the Province of Nova Scotia.

Add the following paragraph 11.1.9:

11.1.9 All of the insurance policies shall contain a clause stating that no change in terms and conditions or cancellation may at any time be made without the full knowledge and consent of the owner.

GC 11.2 CONTRACT SECURITY

Add the following subparagraph 11.2.2.1:

11.2.2.1 "Bonds shall be procured from a Nova Scotia resident agent of an insurance company licensed to do business in Nova Scotia and shall be maintained in good standing and held by the Owner until one (1) year after Substantial Performance of the Work.

Add the following paragraph 11.2.3:

11.2.3 If a Certified Cheque is held as contract security it shall be in an amount equal to ten (10) percent (%) of the Contract Price. Supplement the Certified Cheque as necessary to maintain the amount equal to ten (10) percent (%) of the total amount payable (Contract Price plus HST).

- .1 The Certified Cheque will be deposited at the chartered bank holding The School Board deposits.
- .2 The School Board will return the cheque amount to the Contractor upon satisfactory completion of the contract and duration as specified in the Tender documents.
- .3 Should Contractor default, total amount payable under the Certified Cheque will be the face value of the cheque plus all accrued interest.

- .4 Payment for completion of work, due to failure of performance of the Contractor, shall include all reasonable obligations under the Contract, including architectural and engineering costs arising because of the default of the Contractor.
- .5 Payment for labour and materials shall be limited to those who have a direct contract with the Contractor for the provision of labour and/or material (which includes equipment rental).

GC 12.3 INDEMNIFICATION

Add the following paragraph 12.1.1.3:

- 12.1.1.3 The Contractor shall indemnify and hold harmless the Consultant, its agents and employees from and against claims, demands, losses, costs, damages, actions, suits, or proceeding by third parties that arise out of, or are attributable to, the Contractor's performance of the Contract, provided such claims are attributable to bodily injury, sickness, disease, or death, or to injury to or destruction of tangible property, and caused by negligent acts or omissions of the Contractor or anyone for whose acts the Contractor may be liable, and made in writing within a period of six (6) years from the date of Substantial Performance of the Work, or within such shorter such period as may be prescribed by any limitation statute or the province or territory of the Place of Work.

GC 12.3 WARRANTY

Delete from the first line the word, "The" and substitute the words in paragraph 12.3.2:

12.3.2 "Subject to paragraph 3.15.1, the..."

Add the following paragraph 12.3.7:

- 12.3.7 Warranty repairs or replacements which arise during warranty period which affect the operation of the system shall be attended to immediately upon notification from the Consultant.

END OF SECTION 00 73 00

SECTION 00 73 10 - HRSB GENERAL TERMS & CONDITIONS

1. General

- 1.1. These Terms and Conditions, shall apply only to those documents (Quotations, Request for Proposals and Tenders, herein referred to as Public RFX or RFX) that reference them specifically. In the event of any conflict or disagreement between these Terms and Conditions and the RFX documents, the RFX documents have precedence and will be assumed to be correct.
- 1.2. These Terms and Conditions are intended to cover a wide range of procurements, including goods and services. As such, not all clauses will be applicable in all situations. If Suppliers have questions regarding any of these Terms and Conditions, they should contact the Halifax Regional School Board (HRSB) Procurement Division. To satisfy special requirements, supplementary Terms and Conditions may also apply to some acquisitions. If this is the case, the RFX documents will reference any such documents, in addition to these Terms and Conditions.
- 1.3. For the purpose of these Terms and Conditions HRSB intends to only contract with responsible Suppliers who are in the business of providing the goods and/or services submitted upon, and can provide proof that they can furnish satisfactory performance based on past work experience with HRSB, other companies, or government agencies and have the financial managerial, and resource capabilities for the size of project bid upon. Satisfactory performance includes meeting all of the requirements of the various federal and provincial regulations and agencies for the completion of work and making payment to sub-contractors in a timely basis.
- 1.4. All of the terms, conditions and/or specifications stated or referenced in the Solicitation are assumed to be accepted by the Bidder and incorporated in the Bid.

2. RFX Documents

- 2.1. RFX Documents should be obtained as indicated on the Cover Sheet of the tender document.
- 2.2. While HRSB has tried to ensure accuracy in the RFX documents, it is not guaranteed or warranted by HRSB to be accurate, nor is it necessarily comprehensive or exhaustive.
- 2.3. HRSB cannot ensure the accuracy of RFX documents obtained from any other source. (i.e. Construction Association of Nova Scotia (CANS), Nova Scotia Electronic Tendering Bulletin Board, Project Consultants, etc.).
- 2.4. All inquiries to this RFX are to be directed, in writing, to HRSB Procurement Division representative indicated in the RFX documents. Information obtained from any other source is not official and will not bind HRSB.
- 2.5. HRSB will assume that all Suppliers have resolved any questions they might have about the RFX and have informed themselves as to existing conditions and limitations, site restrictions, etc. before providing a RFX submission.
- 2.6. Nothing in the RFX is intended to relieve Suppliers from forming their own opinions and conclusions with respect to the matters addressed in the RFX or its associated documents.
- 2.7. In the event that HRSB Regional Office (33 Spectacle Lake Drive, Dartmouth) is closed (this includes partial day closures) due to inclement weather on the date and time of the RFX closing, the closing date and time will be extended one (1) business day. Bidders should note that closure of Schools does not necessarily mean the closure of the Board's Regional Office. Closures are detailed on HRSB website.

- 3. Verbal instructions:** Any changes to RFX call, specifications, terms and conditions shall be stated in writing. Verbal statements made by employees or representatives of HRSB, whether or not they appear to have the proper authority, shall not be binding on HRSB.

- 4. Addenda:** HRSB reserves the right to modify the terms of the RFX documents prior to closing, at its sole discretion by addenda.

- 4.1. HRSB Procurement Division will make every effort to ensure the information provided on HRSB.ca is complete and accurate, please report any omissions or discrepancies to the Procurement Division immediately. **Any questions or requests for clarification arising from omissions, discrepancies, or ambiguities, must be made in writing no later than five(5) working days prior to the closing date, not including the closing date.** Replies to requests for clarification, if required, will be made in the form of written addenda, copies of which will be posted on www.HRSB.ca/tender no later than three (3) working days prior to the date of closing, not including the closing date.
- 4.2. By downloading files from the www.hrsb.ca, you will automatically become registered for the applicable RFX. HRSB Procurement Division will make reasonable efforts, strictly as a courtesy, to directly inform registered Suppliers of any addenda, **however it is the sole responsibility of each registered Supplier to ensure that they have all the documents associated with any RFX and, to this end, every registered Supplier should review HRSB Tender Web Site daily.** These documents must be downloaded from the www.hrsb.ca/tender or obtained from HRSB Procurement Division, as applicable. Suppliers must acknowledge receipt of all addenda(s) with their RFX Submission.
5. **Suppliers Responsibility:** Suppliers are solely responsible for their own expenses in preparing, delivering or presenting a RFX and for subsequent negotiations, if any, with HRSB. It will be the responsibility of the Supplier to acquire at the Suppliers cost, any RFX documents as indicated on the Cover Sheet of the tender document.
6. **Existing Conditions:** Suppliers will be deemed to have familiarized themselves with the existing conditions which may affect the performance of required goods, services and construction. No plea of ignorance of such conditions as a result of failure to make all necessary examinations will be accepted as a basis for any claims for extra compensation or an extension of time. Suppliers are to ensure that they understand the expected use for the requested goods, service and construction and submit their RFX submission accordingly.
7. **RFX Submissions**
- 7.1. RFX will close at the time, date and location specified in the RFX documents (Atlantic Time Zone).
- 7.2. All RFX submissions must be received in their entirety on or before the closing time specified. Suppliers are responsible for ensuring that their RFX submission, however submitted, is received on time and at the location specified.
- 7.3. RFX Submissions must be submitted on the forms provided or in such format as directed in the RFX documents. These forms must be legible, complete, filled out in ink, or by typewriter, with the signature in longhand and the completed form shall be without interlineations, alterations or erasures.
- 7.4. If an electronic transmission (i.e. Facsimile, e-mail or HRSB.ca upload) can be accepted, as detailed in the applicable RFX documents, it is the responsibility of the Supplier:
- 7.4.1. to ensure that the submissions are delivered on or before the closing time and date shown on the RFX documents;
- 7.4.2. that the correspondence is legible and properly transmitted; and
- 7.4.3. that the name and number of the RFX is clearly displayed.
- 7.5. Electronic transmission of a RFX submission cannot be used where original documents are required, e.g. bid bonds, certified cheques, samples, etc., or as may be otherwise stated in the RFX documents.
- 7.6. **Sealed RFX submissions** must be delivered to HRSB Receptionist, 1st floor, 33 Spectacle Lake Drive, Dartmouth, Nova Scotia, on or before the closing time and date shown on the RFX documents. The RFX Submission is to be submitted on the provided forms, signed (together with the required RFX security as applicable) in a sealed opaque envelope, clearly identified with Suppliers name, RFX identification number and name, and closing date on the outside of the envelope. RFX Submissions are date and time stamped upon receipt at the Procurement Division (not at any other location) by the Procurement date time stamp. Any submission received after the

closing date and time shown on the RFX documents will not be accepted and will be returned to the Supplier unopened and deemed non-compliant.

- 7.7. Facsimile submissions** received are date and time stamped by the Procurement Division Facsimile, no other time stamp will be considered. A facsimile submission received after the closing date and time shown on the RFX documents will not be accepted and shall be deemed non-compliant. **The facsimile number for the Procurement Department of HRSB is (902) 464-0161. Do not send RFX correspondence to any other fax number.**

7.7.1. Where specified, facsimile submissions are accepted for the convenience of the Supplier; HRSB cannot ensure the confidentiality or error-free receipt of facsimile submissions.

7.8. Amendments/Withdrawn Submissions

7.8.1. Submissions may be withdrawn or amended by written request (on company letterhead or equivalent), prior to RFX closing date and time, but cannot be altered or changed in any way after the RFX closing.

7.8.2. Facsimile transmissions modifying supplier provided information are acceptable when signed by a duly authorized officer or agent. Submission of such electronic transmissions is at the risk of the Supplier. HRSB assumes no liability for the receipt of the electronic transmissions or their proper inclusion with original RFX submission. An electronic submission must be submitted prior to closing time and date specified in the RFX documents.

7.8.3. An amendment to a RFX submission replaces any other RFX submission amendment previously submitted by the supplier; only the last of any RFX submission amendment received will be accepted.

7.9. All RFX submissions must be signed by an authorized representative of the entity.

7.10. HRSB's time clocks will be assumed to be correct in the event of dispute.

7.11. HRSB reserves the right in its sole discretion to clarify any RFX submission after closing by seeking further information from that Supplier, without becoming obligated to clarify or seek further information from any or all other Supplier. However, Suppliers are cautioned that any clarifications sought will not be an opportunity either to correct errors or change their Bids in any substantive manner.

- 8. Brand Name:** Some terminology may be used that would imply or denote a particular supplier. Brand names may be utilized to designate the type and quality of the product requested. Such usage shall not to be construed as restrictive in any way. Suppliers must be prepared to provide samples if required.

9. Substitute

9.1. If the Supplier is offering an equivalent (similar) substitute product to those specified, unless a specific product is requested, the supplier must clearly identify this substitution and supply the manufacturer's name, product number and provide any technical information required so that HRSB can determine the acceptability of the substitute.

9.2. HRSB reserves the right to inspect or test any product bid to determine equivalency, and may require demonstrator or sample items in order to be able to evaluate the items proposed.

9.3. HRSB shall be the sole judge of the acceptability of any substitute or proposed equivalent.

9.4. Specifications may, for technical or logistical reasons, require that the items specified be supplied without substitution.

10. Warranty

- 10.1.** The supplier must describe the duration, type (e.g. on-site, depot, ship-in or carry-in) and terms of the manufacturer's warranty on all goods. If the supplier provides any additional/supplementary warranty coverage, describe this as well.
- 10.2.** If warranties can be upgraded or extended, identify the upgrade costs separately. Do not include warranty upgrade or extension costs in the price unless the RFX documents specifically states that the upgrade is a mandatory requirement.

11. Pricing

- 11.1.** All prices must be extended and totaled, where practical to do so. RFX Submission may be rejected as incomplete if total figures are not provided. In the case of an error in the extension of prices, the unit prices shall prevail.
- 11.2.** Prices must be in Canadian funds, and shall include all shipping, handling, freight, offloading, duty, insurance and any other charges, which are applicable at time RFX is awarded (FOB – Destination). HRSB will not assume responsibility for any goods or services until they have been delivered to the destination(s) specified in the Solicitation. It is the responsibility of the Supplier to find out from the appropriate authorities what rates and charges are applicable to this RFX. No extra charges will be paid by HRSB.
- 11.3.** In the event that a number of Suppliers provide submission in substantially the same amount, HRSB may, at its discretion, call upon those Suppliers to submit further bids.

12. Permits and Taxes: It is the responsibility of the Supplier to ensure that quotations include all taxes, permits, and other charges required to supply the goods, services and construction. The successful Supplier is to comply with all codes, regulations, and by-laws and all government and applicable standards pertaining to the work and job-site including, and not limited to, the Nova Scotia Occupational Health and Safety Act and Regulations. HRSB is required to pay a Harmonized Sales Tax (HST) at a rate specified by the Province of Nova Scotia. This tax is to be shown as a separate line item.

13. Standards

- 13.1.** All goods, services and construction supplied to HRSB shall, when standards are available, be certified in accordance with the applicable code(s), but not limited to:
 - 13.1.1. Canadian Standards Association;
 - 13.1.2. Canadian Government Standards HRSB;
 - 13.1.3. Underwriters Laboratories of Canada; and
 - 13.1.4. And all applicable Federal, Provincial and Municipal regulations and acts.
- 13.2.** HRSB reserves the right to discontinue the purchase of any product/service that does not continue to meet the applicable standard(s).

14. Inspection: HRSB reserves the right to inspect any goods, services or construction supplied either during or after manufacture and delivery, and shall be the sole judge as to the acceptability of goods, services and construction to meet the needs of HRSB and fulfills the requirements as specified.

15. Rejection of RFX Submissions/Compliance:

- 15.1.** Failure to comply with any of the mandatory terms or conditions contained or referenced in the RFX documents shall result in the rejection of the RFX submission.
- 15.2.** HRSB specifically reserves the right to accept or reject any or all RFX submission and implies no obligation on HRSB to accept any RFX submission, a portion of any RFX submission or any RFX submission. HRSB reserves the right to cancel any RFX in its entirety and shall not be responsible, in any manner, for expenses incurred by the

Supplier for preparing a RFX submission. HRSB may award all or a portion of the work to one or more Suppliers. Without limiting the generality or any other provision hereof, HRSB reserves the right to reject or accept any RFX submission:

- 15.2.1. that contains any irregularity or informality;
- 15.2.2. that is not accompanied by the security documents required;
- 15.2.3. that contains an alteration in the quoted price that is not initialed by the or on behalf of the Supplier;
- 15.2.4. that is incomplete or ambiguous;
- 15.2.5. contains clauses additional to the RFX that are "qualified" or "conditional"; and/or
- 15.2.6. that does not strictly comply with the requirements contained in these instructions.

15.3. HRSB reserves the right to waive minor non-compliance where such non-compliance is not of a material nature in its sole and absolute discretion, or to accept or reject in whole or in part any or all RFX submissions, with or without giving notice. Such minor non-compliance will be deemed substantial compliance and capable of acceptance. HRSB will be the sole judge of whether a RFX submission is accepted or rejected.

15.4. HRSB reserves the right to accept or reject any or all RFX submission, not necessarily accept the lowest priced RFX submission, or to accept any RFX submission which it may consider to be in its best interest.

16. Evaluation criteria: If applicable, award of the RFX will be based on "Best Value" (which includes, but not limited to; price, discounts, product specifications, warranty, delivery, reference checks, etc.

17. Cancellation/no award

17.1. Issuing a RFX implies no obligation on HRSB to accept any submission, or a portion of any submission. The lowest or any RFX submission will not necessarily be accepted.

17.2. RFX's may be cancelled in whole or in part by HRSB in its sole discretion when:

- 17.2.1. the RFX submission price exceeds the funds allocated for the purchase;
- 17.2.2. there has been a substantial change in the requirements after the RFX has been issued;
- 17.2.3. information has been received by the RFX after the RFX has been issued that the RFX believes has substantially altered the procurement;
- 17.2.4. there was insufficient competition in order to provide the level of service, quality of goods or pricing required.

17.3. If no compliant RFX submission is received in response to a RFX, the RFX reserves the right to enter into negotiations with one or more suppliers in order to complete the procurement.

17.4. HRSB will be the sole judge of whether there is sufficient justification to cancel any RFX.

17.5. No action or liability will lie or reside against HRSB in its exercise of its rights under this section.

18. Eligibility and Conflict of Interest

18.1. A RFX Submission may not be eligible for acceptance if current or past corporate or other interests of the Bidder may, in HRSB's opinion, give rise to a conflict of interest in connection with a project.

18.2. Suppliers are cautioned that acceptance of their RFX submission may preclude them from submitting a response on subsequent phases where a conflict of interest may arise. Suppliers should study the project implementation strategy to determine whether or not they plan to submit response on subsequent phases.

18.3. If the RFX submission covers the first phase of what may prove to be a multi-phased project, the successful Supplier on the initial phase may be permitted to respond on subsequent phases as long as, in HRSB's opinion, no conflict of interest would be created in performance of the work by that Supplier.

18.4. Sub-contracting to any firm or individual whose current or past corporate or other interests may, in HRSB's opinion, give rise to a conflict of interest in connection with this bid will not be permitted. This includes, but is not limited to, any firm or individual involved in the preparation of the RFX documents.

- 19. Disputes:** In case of dispute as to whether or not an item or service quoted or delivered meets RFX requirements, the decision of HRSB, or its authorized representative, shall be final and binding on all parties.
- 20. Exceptions:** A RFX submission shall be considered an agreement to all terms and conditions provided herein and in various RFX documents, unless specifically noted otherwise in the RFX documents.
- 21. Irrevocable Offer:** A RFX submission represents an irrevocable offer, unless otherwise stated in the RFX documents and shall be valid for a period of ninety (90) days following the closing date for RFX submissions.
- 22. Patent right and royalties:** The successful Supplier shall pay all royalties and patent license fees required for the performance of the work. The successful Supplier shall hold HRSB harmless from and against claims, demands, losses, costs, damages, action suits or proceedings arising out of the successful Supplier's performance of the Contract which are attributable to an infringement or an alleged infringement of a patent of invention by the successful Supplier or anyone for whose acts the successful Supplier may be liable.
- 23. Assignment:** The successful Supplier shall not assign the Contract (or portion thereof) nor sub-contract without the prior written consent of HRSB, consent shall not be unreasonably withheld.
- 24. Purchase Order:** Work by the Supplier will begin only with the issuance of HRSB's official purchase order and/or any Contract Documents as applicable. The purchase order number must appear on any/all invoices covering same. No work is authorized until the successful Supplier has received an official HRSB purchase order and/or required Contract Documents. HRSB accepts no responsibility for any work performed prior to the issuance of a purchase order and/or required Contract Documents.
- 25. Delivery**
- 25.1.** Where the RFX Document includes a mandatory delivery schedule, HRSB will assume that the Supplier can meet the requested schedule and is satisfied that the goods or services required will be available for delivery on the requested date(s).
- 25.2.** If Suppliers wish to specify a delivery schedule different from that requested in the RFX document, they must provide specific delivery dates or a schedule in calendar days from the date a Purchase Order is issued. RFX Submission that do not meet the delivery schedule as requested in the RFX documents may be rejected.
- 25.3.** Time is of the essence, and supplier's delivery schedule is legally binding. HRSB reserves the right to assess penalties or cancel awards to Suppliers who fail to meet their stated delivery or completion dates.
- 26. Invoices**
- 26.1.** All invoices are to be submitted quoting the Purchase Order number (as applicable). The H.S.T. number must be shown on each invoice. Invoices must include a description of the goods, services and construction provided with HRSB Work Order Numbers (where applicable). Invoices must also clearly indicate list price, discounts offered and net price, if applicable. All invoices are to be forwarded to:
- Halifax Regional School Board
33 Spectacle Lake Drive
Dartmouth, NS, B3B 1X7
Attn: Accounts Payable**
- 26.2.** All Suppliers are required to maintain their tax status in good standing. In this regard, Suppliers are advised that verification of good standing with the Nova Scotia Minister of Finance and Revenue Canada (GST/HST) may be carried out prior to the award of a contract to a successful Supplier.

26.3. In order to maximize efficiencies, as well as to be more environmentally friendly, vendor payments are now being paid via EFT (Electronic Funds Transfer) direct deposit to vendor bank accounts. A vendor direct deposit form must be filled out with banking information for EFT payments.

27. Payment:

27.1. HRSB's normal payment terms are thirty (30) days from acceptance that the goods, services and construction meet the specifications. Alternative payment schedules may be proposed and are to be shown as an option and list any additional discounts to HRSB. Early payment discount terms (minimum period ten (10) days) may be considered in the evaluation of the RFX response. Payment of term discount invoices will be calculated from the date of the invoice or goods have been received, whichever is later. Discount terms must appear on the invoice.

27.2. The Supplier shall make application for payment at least monthly with the application based on progress or services provided during that month. HRSB will hold back ten percent (10%) of any payment until the lien periods have expired and the Supplier has provided HRSB with a complete release of any lien registered as a result of any work carried out by the Supplier, or any sub-contractor or supplier to the Supplier.

28. Right to offset: The successful Supplier agrees that HRSB may apply payments for goods, services and construction to any amount owing to HRSB by the Supplier or supplier including any related administration fees.

29. Confidentiality: The Supplier shall keep private, treat as being confidential, and not make public or divulge during, as well as after, the term on this Agreement, any information or material to which the Supplier or staff becomes privy as a result of acting under this Agreement without having first obtained HRSB's consent in writing.

30. Freedom of Information and Protection of Privacy (FOIPOP) Act and Personal Information International Disclosure Protection Act (PIIDPA)

30.1. As a public body, HRSB is subject to provincial legislation, Freedom of Information and Protection of Privacy (FOIPOP) Act. RFX submissions and associated documents are subject to disclosure and protection under this legislation. In the event an application for disclosure of information is made under FOIPOP, HRSB is subject to the disclosure and protection of information in accordance with that legislation. Suppliers are recommended to visit the following websites for more information on the Act: <http://www.gov.ns.ca/just/IAP/default.asp> and <http://www.foipop.ns.ca/>

30.2. The Province of Nova Scotia is required to comply with the Personal Information International Disclosure Protection Act (PIIDPA)(S.N.S 2006, c.3). The act creates obligations for the Province of Nova Scotia and its service providers when personal information is collected, used or disclosed. Requirements include limiting storage, access and disclosure of personal information to Canada, except as necessary or otherwise required by law. Suppliers are recommended to visit the following PIIDPA websites for more information on the Act: http://nslegislature.ca/legc/bills/60th_1st/3rd_read/b019.htm and <http://www.gov.ns.ca/just/IAP/PIIDPAquest.asp#p01>

30.3. The Supplier acknowledges and confirms that it is a "service provider" as defined in the Personal Information International Disclosure Protection Act, SNS 2006 c. 3 ("PIIDPA"), that the Supplier has read and understands its obligations as a service provider thereunder and that as a service provider It is legally bound by the obligations imposed on it by PIIDPA. It is a condition precedent to HRSB entering into the Agreement with the Supplier that the Supplier irrevocably undertakes covenants and agrees to be bound by and comply with the obligations imposed on it as a service provider under PIIDPA.

30.4. The Supplier further covenants, warranty and represents to HRSB that it will not at any time provide or allow the release of personal information to which it has access in its capacity as a service provider to HRSB in response to any "foreign demand for disclosure" or permit or allow the "unauthorized disclosure of personal information" as each of those terms are defined in PIIDPA.

- 30.5.** The Supplier shall implement and strictly enforce security arrangements that will ensure that all personal information that it collects or uses on behalf of HRSB is protected at all times from unauthorized access or disclosure and shall confirm in writing to HRSB, upon request, the details of such security arrangement. The Supplier also agrees to implement and enforce any additional security procedures as may be required by HRSB from time to time to protect the personal information that the Supplier collects on behalf of HRSB. HRSB shall be authorized, upon giving prior written notice to the Supplier, to enter the premises of the Supplier during normal business hours for the purpose of conducting an audit of the security arrangement referenced herein.
- 30.6.** All personal information that the Supplier obtains or becomes aware of while providing services to HRSB is not and shall not be or be deemed to be the property of the Supplier. The Supplier acknowledges and agrees that it will not, either directly or indirectly, acquire any rights to use or own any such information other than the right to use it for the sole purpose of fulfilling its obligations to HRSB under the Agreement.
- 30.7.** All RFX submissions become the property of HRSB. By providing a RFX submission, the supplier hereby grants HRSB a license to distribute, copy, print or translate the RFX submission for the purposes of the RFX. Any attempt to limit HRSB's right in this area may result in rejection of the RFX submission.
- 30.8.** Suppliers RFX submission may be subject to disclosure under the Province's "freedom of information" legislation. By submitting a RFX submission, the Supplier agrees to the appropriate disclosure of the information supplied, subject to the provisions of the governing law. HRSB cannot guarantee the confidentiality of the complete content of any RFX submissions after the procurement has been awarded to the successful supplier.
- 30.9.** During the delivery and installation of goods and/or services, the supplier or supplier's staff may have access to confidential information belonging to HRSB. Should this occur, the supplier must ensure that such information is not released to any third parties or unauthorized individuals; failure to comply may result in legal action being taken and/or the supplier's disqualification from any further RFX's issued by HRSB.
- 31. Indemnification:** The Supplier shall indemnify and hold harmless HRSB, their agents, representatives and employees from and against all claims, demands, losses, costs, damages, actions, suits or proceedings arising out of, or resulting from the performance of this work, provided that any such claim is caused in whole or in part by the negligent act or omission of the Supplier, and sub-contractor, supplier, licensee, anyone directly or indirectly employed by any one of them or anyone for whose act any of them is liable, regardless of whether or not it is cause in part by a party indemnified hereunder.
- 32. Insurance:** Unless otherwise stated, Commercial General Liability Insurance with policy limits of not less than two (2) million dollars (\$2,000,000.00) must be filed with the Procurement Department of HRSB; such insurance shall be in the name of the Supplier and HRSB. The insurance must include non-owned automobile liability with policy limits of not less than two (2) million dollars (\$2,000,000.00). All insurances are to be maintained in good standing for the duration of the Contract.
- 33. Termination for convenience:** HRSB may terminate a contract, in whole or part, whenever HRSB determined that such termination is in the best interest of HRSB, without just cause giving sixty (60) days written notice to the proponent. However, in no event shall the proponent be paid an amount that exceeds the submitted price for the work performed.
- 34. Termination for default:** When the proponent has not performed or has unsatisfactorily performed the contract, HRSB may terminate the contract for default. Upon termination for default, outstanding payment will be withheld at the discretion of HRSB. Failure on the part of the proponent to fulfill the contract obligations shall be considered just cause for termination of the contract. The proponent will be paid for work satisfactorily performed prior to termination, less any excess costs incurred by HRSB in re-procuring and completing the work.
- 35. Workers Compensation:** Prior to commencing the work, the Supplier shall provide a current clearance letter from the Workmen's Compensation HRSB (WCB) and must maintain this coverage during the whole term of the Contract.

- 36. WHMIS:** All controlled products supplies to HRSB must have approved Workplace Hazardous Materials Information System (WHMIS) supplier labels; Material Safety Data Sheets must also be supplied. Failure to comply with this requirement may result in rejection of any shipment, and may result in cancellation of the order and the return of goods to the supplier at the supplier's expense.
- 37. Health and Safety Act:** The Supplier shall take every precaution to ensure that every employee, self-employed person and employer performing work in respect of the project complies with the latest revisions of the Nova Scotia Occupational Health and Safety Act and the Regulations. Halifax Regional School HRSB Occupational Health and Safety Policy BP 303.1, and all other safety measures as required by authorities having jurisdiction.
- 38. Site Safety Plan:** Before being permitted access to the site to commence construction the Supplier may be requested provide HRSB with a written Project Specific Site Safety Plan. The Site Safety Plan provided shall be a written course of action that, through a pre-job evaluation, identifies and sets out specific actions to be taken to eliminate or control hazards associated with the work to be performed and to also deal with concerns or hazards that may develop during the course of the project. This Plan shall include, but not be limited to, identification of safety hazards anticipated during the project, solutions to those hazards, safety procedures, identification of designated safety officers and provision for safe access to the site for HRSB staff and or Consultants. Receipt and acceptance of the safety plan shall be mandatory prior to commencement of work.
- 39. Extension to the Broader Public Sector**
- 39.1.** HRSB may choose to allow the Broader Public Sector to purchase goods or services from some RFX's. The Broader Public Sector are generally permitted to purchase from "Standing Offers", which are contracts resulting from a RFX. Other RFXs may also be available to the Broader Public Sector; if so, the Solicitation documents will state this.
- 39.2.** By submitting a response to a RFX, the Supplier agrees to extend the same pricing to other eligible Broader Public Sector institutions as per the terms and specifications in the Solicitation
- 40. Governing Laws and Trade Agreements**
- 40.1.** Unless the RFX documents specifically state otherwise, the RFX, all submissions, and any subsequent contracts will be construed and interpreted in accordance with the laws of the Province in which the Solicitation was issued.
- 40.2.** RFX's subject to the Atlantic Procurement Agreement, the Agreement on Internal Trade, any other inter-provincial trade agreements, or any international trade agreements, will be specifically identified as such in the public notice and/or the Solicitation documents.
- 40.3.** Information of any applicable trade or procurement agreements and/or legislation can be obtained by contacting HRSB Procurement Department.
- 40.4.** Suppliers agree to comply with all applicable laws, regulations and standards, including all labour, occupational health & safety, and worker compensation requirements of the Province.
- 40.5.** HRSB may consider and evaluate any RFX submission from other jurisdictions on the same basis that the purchasing authorities in those jurisdictions would treat a similar RFX submission from a supplier located in this Province. HRSB will be the sole judge of whether these conditions will be used and the extent to which they will be applied.
- 40.6.** Suppliers registered to do business in any Atlantic Province can bid on RFX issued by any other Atlantic Province without having to satisfy any local registration or residency requirements.
- 40.7.** Under Canadian law (and international agreements), your RFX submission must be arrived at separately and independently, without conspiracy, collusion or fraud; see:
<http://www.competitionbureau.gc.ca/internet/index.cfm?itemid=1243&lg=e> for further information.

41. Other General Conditions

- 41.1.** No RFX submissions shall be accepted from any person or corporation who, or which, has a claim or has instituted a legal proceeding against HRSB or against whom HRSB has a claim or has instituted a legal proceeding with respect to a previous contract, without prior approval of HRSB.
- 41.2.** The Supplier shall perform the obligations of this Contract in a good and workmanlike manner in compliance with all applicable legislation in effect in Nova Scotia, and in accordance with industry standards and practice.
- 41.3.** The Supplier shall be solely responsible for all means, methods, techniques and procedures necessary for performing the work required under this Contract.
- 41.4.** All Suppliers must comply with the Nova Scotia Corporations Registration Act (CRA) or the Partnerships and Business Names Registration Act (PBNRA) as one of the conditions of doing business with the Province of Nova Scotia. In this regard, Suppliers are advised that verification of registration and good standing may be carried out prior to the final award of a contract to a successful Supplier. Suppliers residing outside Nova Scotia (which are not otherwise carrying on business in Nova Scotia) are expected to be registered in an equivalent manner in their respective jurisdictions.
- 41.5.** Unless otherwise specified, all materials installed by the Supplier as part of this Contract shall be new and shall comply with the specifications and any applicable building codes. The Supplier is, at all times, responsible for correcting any defective work or materials at the Supplier's cost, and payment by HRSB to the Supplier does not relieve the Supplier of that responsibility.
- 41.6.** Where applicable, the end user must be provided with complete operation manuals, warranty registration forms, user licenses/ authentications and/or other associated documentation normally provided by the manufacturer, reseller, installer and/or consultant.
- 41.7.** The Supplier shall, at all times, keep HRSB premises free from accumulations of waste and rubbish. Disposal of all waste and rubbish shall be at approved waste disposal sites.
- 41.8.** If the Supplier files for bankruptcy, becomes insolvent or fails to perform the Supplier's obligations under this Contract in a timely and workmanlike manner, HRSB may, by written notice, immediately terminate the employment of the Supplier and the Supplier shall be entitled only to the value of work performed and materials supplied up to the date of the termination.
- 41.9.** The Supplier shall not permit smoking by any of its employees or sub-contractors on HRSB property and will act in accordance to the Halifax Regional School HRSB policy BP101.3 Tobacco-Free Schools and Workplaces.
- 41.10.** The Supplier warrants its work and materials for a minimum of twelve (12) months after the date of substantial completion.
- 41.11.** The Supplier, if performing work on HRSB property may be required to provide a safety program certified with the Nova Scotia Construction Safety Association or with an approved alternate safety association and/or program.
- 41.12.** HRSB reserves the right to split an award amongst Suppliers as deemed in the best interests of HRSB.

END OF SECTION 00 73 10

SECTION 01 11 00 - HRSB SUMMARY OF WORK

1. Project Location & General Scope

1.1. *TERENCE BAY ELEMENTARY SITE, 1714 LOWER PROSPECT RD*

1.2. Scope: Refer to Section 00 00 15 for scope and schedule information.

2. Contract Documents

2.1. Work will be performed under CCDC-2, 2008 contract.

3. General Conditions

3.1. Halifax Regional School Board and CCDC-2, 2008, form an integral part of this Project Manual, a copy of which is bound herein.

4. Project Manual

4.1. Sections of the Project Manual are numbered in conformance with the Master List of Section Titles and Numbers, CSC Document 004E, published jointly by Construction Specifications Canada and The Construction Specifications Institute (USA). Sections are arranged in their standard format.

4.2. Sections are written as units of the Work which have been assigned numbers in conformance with the CSC/CSI system. They are arranged in sequence for this Manual. Gaps in the order of numerical sequence do not indicate that a section has been inadvertently omitted from this Manual, but, rather that a Section is not required for completion of the Work.

4.3. Wherever the project location building name occurs in the Contract Documents it shall be taken to mean all work included in the Contract.

4.4. Wherever in the Contract Documents the words "approval", "approved", "direction", "directed", "selection", "selected", "request", "requested", "report", and similar words are used, such approvals, directions, selections, requests and reports shall be given by the HRSB unless specifically stated otherwise.

4.5. Wherever in the Contract Documents the word "provide" is used in any form, it shall mean that the Work concerned shall include both supply and installation of the products required for completion of that part of the Work.

4.6. Wherever in this Project Manual it is specified that Work is to proceed or to meet approval, direction, selection or request of jurisdictional authorities or others, such approval, direction, selection or request shall be in writing.

5. Errors & Omissions

- 5.1.** If errors or omissions are observed in the Contract Documents, immediately notify the HRSB Procurement in writing of all such errors or omissions. In the event no such notice is given, the Contractor will be held responsible for the results of any such error or omission and the cost of rectifying the same.

6. Division 1

- 6.1.** The provisions of all Sections of **Division 1** shall apply to each Section of this Specification.

7. Wage Rates

- 7.1.** Pay all employees engaged on the Work a wage not less than the minimum wage per hour as set out by the Province of Nova Scotia. For overtime work beyond 48 hours in any one week, pay no employee at a rate of less than one and one-half times the minimum wage per hour noted above. Provide for these wage rates in tendered contract amount.

8. Work Performed Under Separate Contracts

- 8.1.** Work not to be included in the Contract, as noted "NIC" on the Drawings, shall be governed by Article 37, Separate Contracts, of General Conditions of Contract.
- 8.2.** Furniture installation will be carried out by others.
- 8.3.** Computer installation will be carried out by others.

9. Project Schedule

- 9.1. Refer to Section 00 00 15 Description of Work.**
- 9.2.** Existing services (mechanical & electrical) will need to be maintained through the renovations.
- 9.3.** During construction, all life safety systems as well as mechanical and electrical systems must be in active, usable condition to permit the school to operate or alternate methods used to ensure the safe operation of the school as directed by HRSB project representative.
- 9.4.** As construction progresses revise the schedule to compensate for any delays or unforeseen activities so as to maintain the contract completion date. Each schedule submission is to be complete with a statement indicating the changes made, the reason they were changed and confirmation that the project completion date will not change. The above schedule information is to be submitted monthly or more often if necessary.

10. Site Progress Records

- 10.1. Maintain at site a permanent written record of progress of Work. Make the record available at all times with copies provided when requested. Include in record each day:
 - 10.1.1. Commencement and completion dates of the Work of each trade in each area of Project.
 - 10.1.2. Attendance of Contractor's and Subcontractor's Work forces at Project and a record of the work they perform.
 - 10.1.3. Visits to site by representatives of the Owner, Engineer, jurisdictional authorities, Contractor, Subcontractors, and suppliers.
- 10.2. Maintain a progress chart in approved format. Show on chart proposed Work schedule and progress of Work by Contractor and Subcontractor.

11. Examination

- 11.1. Site:
 - 11.1.1. Examine site, and ensure that site conditions have been examined, that all are fully informed on all particulars which affect Work thereon and at the place of construction, and in order that construction proceeds competently and expeditiously.
 - 11.1.2. Ensure by examination that all physical features, and working restrictions and limitations which exist are known.
- 11.2. Previously Completed Work:
 - 11.2.1. Verify dimensions of existing Work in place before construction of Work to be incorporated with it.
 - 11.2.2. Verify that previously executed Work and surfaces are satisfactory for construction, and that performance of subsequent Work will not be adversely affected.
 - 11.2.3. Commencement of Work will constitute acceptance of site conditions and previously executed Work as satisfactory.
 - 11.2.4. Report to Engineer defects in prior Work which will affect quality of subsequent Work, or construction schedule.
- 11.3. Construction Measurements:
 - 11.3.1. Before commencing installation of Work, verify that its layout is accurate in accordance with intent of Drawings, and that locations, elevations, and clearances to adjacent infrastructure are maintained.
 - 11.3.2. If Work is installed in wrong location, rectify it before other Work concerned proceeds.

12. PROTECTION OF WORK, PROPERTY & PERSONS

- 12.1.** Include in Work necessary methods, materials, and construction to ensure that no damage or harm to Work, materials, property and persons results from the Work of this Contract. Temporary facilities relating to protection are specified in Section 01 52 00.
- 12.2.** Protect, and if damaged make good, adjacent private and public property.
- 12.3.** Keep surfaces, on which finish materials will be applied, free from grease, oil, and other contamination which would be detrimental in any way to the application of finish materials.
- 12.4.** Protect finished surfaces of completed Work from damage by restriction of access or by use of physical means suitable to the material and surface location. Establish with each Subcontractor the suitability of such protection in each case.
- 12.5.** Protect existing underground infrastructure, mechanical, electrical, telephone and similar services from damage. If necessary, relocate active services to ensure that they function continuously in safety and without risk of damage.
- 12.6.** Cap off and remove unused utility services encountered during Work after approval is given by the utilities concerned or jurisdictional authorities, whichever may apply. Relocation, removal, protection and capping of existing utility services shall be performed only by the applicable utility and of other services by licensed mechanics.
- 12.7.** To prevent soiling or damage to finish flooring where pedestrian traffic occurs after the flooring has been installed, install and maintain 6 mil. polyethylene membrane or reinforced kraft paper temporary protection, secured in place and with joints sealed by reinforced pressure sensitive tape.
- 12.8.** Install plywood panels of minimum ¼" thickness over completed finish flooring materials, on which further construction Work is performed by other trades or delivery of products is made, or both. Seal joints between panels with reinforced pressure sensitive tape.
- 12.9.** Prevent spread of dust beyond the construction zone by wetting, or by other approved means, as it accumulates.
- 12.10.** Outside work areas shall be appropriately demarked and/or surrounded by rigid chain link panels or fencing to prevent unauthorized entry to the work area. Any area of roof having work completed is to be covered below with this fencing approximately 10' from the edge of the building. It is to be maintained at all times throughout the project. All waste disposal bins are to be fenced in using the same type of fencing as indicated above during working hours. After working hours, all waste disposal bins shall be located a minimum of 25 feet from any structure. Any windows where the debris chute is located are to be covered. All entrances below the roof area are to have covered scaffolding erected to ensure a safe travel path to a distance of ten

feet from edge of building. All workers shall contain their activity to the work site area. Access to the school shall only be allowed as planned in coordination with HRSB Operations and the school administration.

- 12.11.** The contractor is responsible for security of all project materials and access to the project site and/or the school through the project site at all times until completion of work and acceptance of the finished project by HRSB. Such additional security costs for security personnel or other means of security as deemed necessary by the contractor will be the sole responsibility of the contractor. The HRSB will provide security personnel up to and including the Substantial Completion date as noted on the bid submission documents.
- 12.12.** The contractor shall keep the work site free from accumulated debris caused by the employees or work and shall remove all debris at the end of each work shift. Debris shall not be deposited in HRSB controlled garbage and/or recycling containers.
- 12.13.** All waste materials and debris created during demolition and/or construction shall be disposed of in a dumpster provided by the contractor, to be removed at the end of the construction project, using a methodology that is in compliance with the applicable HRM solid waste by laws. Otherwise, the material must be removed and disposed of off site at the end of each working day. The waste materials may not be stored on site unless they are held in an approved project dumpster no closer than twenty five (25) feet from any structure.
- 12.14.** All temporary structures such as portable washroom facilities, materials storage trailer, work trailer, debris dumpster, vehicles, etc., shall be located a minimum of (25) twenty-five feet from the school building.
- 12.15.** Where applicable, a hot work permit will be required to be completed prior to commencement of work and all conditions of the permit must be maintained until completion of hot work. A copy of the hot work permit signed by the contractor representative shall be provided to HRSB upon completion of each hot work session. Contractor must assign a designated fire watch as noted on the permit document who shall remain on site for three hours after completion of each hot work session.
- 12.16.** A school washroom will be designated for use where appropriate. However, protection of the surfaces as indicated above must be maintained. It should also be noted that access to the building during summer months will be limited for security reasons. Contractor is responsible to provide temporary portable washroom facilities for general use of contractor staff.
- 12.17.** Access to Interior of School - All interior access is to be scheduled with the PM. This will allow for notice to the school admin., custodial and possible scheduling of a security guard for after hour access.
- 12.18.** Adhesives / Torch Work - All adhesive use and torch work must be completed after school
- ##3857 RECLADDING – TERENCE BAY ELEMENTARY

hours.

13. Cleaning

- 13.1.** Ensure that during and after construction the public streets and existing asphalt parking lot are cleaned as required.

14. Salvage

- 14.1.** Unless otherwise specified, salvaged material resulting from construction, and surplus materials and construction debris shall become property of Contractor, who must dispose of it away from Site.

15. Site Limitations

- 15.1.** Since the existing building will be occupied during the Work (in accordance with the Phasing Schedule) the Architect will designate the precise areas on the site which may be utilized for work and storage, and where personnel will be permitted to be present. Refer also to Drawings. Allow for hoarding to secure construction areas from occupied portions of the Building and Site.
- 15.2.** All access to the construction site is to be coordinated with the Project Manager for HRSB and communicated at the pre-construction meeting.
- 15.3.** Any Work carried out in the building is to be carried out during hours approved by the School Administration.
- 15.4.** Any disruption to services within the building must occur during hours approved by School Administration.
- 15.5.** Any Work which may have an adverse affect on the occupancy functions, must have prior approval of the School Administration and **may** require scheduling during off-hours.

16. Security Regulations

- 16.1.** Perform Work in conformance to the security regulations of the building as directed by the Project Manager for HRSB.

17. Project Identification

- 17.1.** No project sign is required on this Project.

18. Owner's Occupancy

- 18.1.** The Owner reserves the right to occupy and use portions of the Project, whether partially or
##3857 RECLADDING – TERENCE BAY ELEMENTARY

entirely completed, or whether completed on schedule or not, provided such occupancy does not interfere with the Contractor's continuing Work.

- 18.2.** Partial occupancy or installation by the Owner of his equipment shall not imply acceptance of the Project in whole, or in part, nor shall it imply acknowledgement that terms of the Agreement are fulfilled.

END OF SECTION 01 11 00

SECTION 01 11 25 - PRICES

1. General

- 1.1. Prices included in the Contract shall be complete for the applicable Work, and shall include for each price:
 - 1.1.1. Expenditures for wages and for salaries of workmen, engineers, superintendents, draftsmen, foremen, timekeepers, accountants, expeditors, clerks, watchmen and such other personnel as may be approved, employed directly under the Contractor and while engaged on the applicable Work at the site and expenditures for travelling and board allowances of such employees when required by location of the applicable Work or when covered by trade agreements and when approved; provided, however, that nothing shall be included for wages or salary of the Contractor if an individual, or of any member of the Contractor's firm if the Contractor is a firm or the salary of any officer of the Corporation if the Contractor is a corporation, unless otherwise agreed to in writing.
 - 1.1.2. Expenditures for material used in or required in connection with the construction of the applicable Work including material tests and required by the laws or ordinances of any authority having jurisdiction and not included under Subparagraph .9.
 - 1.1.3. Expenditures for preparation, inspection, delivery, installation and removal of materials, equipment, tools and supplies.
 - 1.1.4. Temporary facilities as required for the applicable Work.
 - 1.1.5. Travelling expenses properly incurred by the Contractor in connection with the inspection and supervision of the applicable Work or in connection with the inspection of materials prepared or in course of preparation for the applicable Work and in expediting their delivery.
 - 1.1.6. Rentals of all equipment whether rented from the Contractor or others, in accordance with approved rental agreements including any approved applicable insurance premiums thereon and expenditures for transportation to and from the site of such equipment, costs of loading and unloading, cost of installation, dismantling and removal thereof and repairs or replacements during its use on the applicable Work, exclusive of any repairs which may be necessary because of defects in the equipment when brought to the Work or appearing within thirty (30) days thereafter.
 - 1.1.7. The cost of all expendable materials, supplies, light, power, heat, water and tools (other than tools customarily provided by tradesmen) less the salvage value thereof at the completion of the applicable Work.

- 1.1.8. Assessments under the Workmen's Compensation Act, the Unemployment Insurance Act, Canada Pension Act, statutes providing for government hospitalization, vacations with pay or any similar statutes; or payments on account of usual vacations made by the Contractor to his employees engaged on the applicable Work at the site, to the extent to which such assessments or payments for vacations with pay relate to the Work covered by the specified price; and all sales taxes or other taxes where applicable.
- 1.1.9. The amounts of all Subcontracts related to the specified price.
- 1.1.10. Premiums on all insurance policies and bonds called for under this Contract as related to the specified price.
- 1.1.11. Royalties for the use of any patented invention on the applicable Work.
- 1.1.12. Fees for licences and permits in connection with the applicable Work. No Building Permit is required for the project.
- 1.1.13. Duties and taxes imposed on the applicable Work.
- 1.1.14. Such other expenditures in connection with the applicable Work as may be approved.
- 1.1.15. Provided always that except with the consent of the Owner, the above items of cost shall be at rates comparable with those prevailing in the locality of the Work.

END OF SECTION 01 11 25

SECTION 01 11 41 - PROJECT COORDINATION

1. Requirements Included

- 1.1. Each Trade Contractor's responsibilities include the coordination of Work within his own Contract and with the Work of other Contracts.

2. Related Requirements

- 2.1. Project Meetings: Section 01 31 19
- 2.2. Submittals: Section 01 33 00

3. Description

- 3.1. Coordinate Work on which subsequent Work depends to facilitate mutual progress, and to prevent conflict between parts of the work.
- 3.2. Ensure that each Section makes known for the information of the Construction Manager and other Sections, the environmental and surface conditions required for the execution of its Work, and the sequence of others Work required installation of its Work.
- 3.3. Ensure that each Section, commencing Work, and that each Section is assisted in the execution of its preparatory Work by Sections depending upon its preparation.
- 3.4. Deliver materials supplied by one Section to be installed by another well before the installation begins.
- 3.5. Sections giving installation information in error, or too late to incorporate in the Work, shall be responsible for having Work done which was thereby additionally made necessary.
- 3.6. Coordinate warranty conditions of interconnected Work to ensure that full coverage is obtained.
- 3.7. Remove work installed in error which is unsatisfactory for subsequent Work.

4. Cutting And Patching

- 4.1. Include under Work of this Section all cutting and patching of asphalt required by the Work.
- 4.2. Finish new surfaces flush with existing surfaces.
- 4.3. Cut and patch as required making work fit.
- 4.4. Make cuts with clean, true, smooth edges.
- 4.5. Patching of existing or new asphalt shall be performed only by workmen with expertise in that particular trade and who normally perform that Trade.
- 4.6. Replace, and otherwise make good, damaged or defective Work. If required by the Construction Manager.

- 4.7. Do not endanger Work or property by cutting, digging, or similar activities. No Section shall cut or alter the Work of another Section unless approved by the Section which has installed it.
- 4.8. Cut and drill with true smooth edges and to minimum suitable tolerances.
- 4.9. If required, before cutting, drilling, or sleeving structural load bearing elements, obtain approval of location and methods.
- 4.10. Cutting, drilling and sleeving of Work shall be done only by the Section which has installed it. The Section requiring drilling and sleeving shall inform the Section performing the Work of the location and other requirements for drilling and sleeving. The Contractor shall directly supervise performance of cutting and patching.
- 4.11. Cutting and Patching for Holes Required by Mechanical & Electrical Work:
 - 4.11.1. Include under Work of Mechanical Divisions cutting or provision of holes up to 8" in diameter and related patching.
 - 4.11.2. Include under Work of this Section holes and other openings required by the work of Mechanical Divisions which are larger than 8" in diameter or least dimension, and chases, bulkheads, furring and required patching. This Section shall be responsible for determination of Work required for holes in excess of 8" diameter or least dimension.
 - 4.11.3. Include under the Work of Electrical Divisions all cutting or provision of holes and related patching for the Work of that Division.
- 4.12. Include under Work of this Section all other cutting and patching required by the Work except as described in Clause .11 above.
- 4.13. Patching or replacement of damaged Work shall be done by the Subcontractor under whose Work it was originally executed, and at the expense of the Subcontractor who caused the damage.
- 4.14. Make patches invisible in final assembly.

5. Quality Assurance

- 5.1. Requirements of Regulatory Agencies:
 - 5.1.1. Make known and coordinate the requirements of jurisdictional authorities, as made explicit by the Contract Documents, and by representatives of such authorities
- 5.2. Source Quality Control:
 - 5.2.1. Ensure that Work meets specified requirements
 - 5.2.2. Schedule, supervise and administer inspection and testing as specified in Section 01 45 00.
- 5.3. Job Records:
 - 5.3.1. Maintain job records and ensure that such records are maintained by subcontractors.

6. Submittals

- 6.1. Prepare a Project schedule in accordance with Section 01 33 00, and ensure that all subcontractors and suppliers are aware of the details of this schedule, and progressively of their general compliance with the schedule.
- 6.2. Become aware of the required submittals specified in each Section, and expedite submission of such submittals so as not to hinder the Project Schedule.
- 6.3. Review submittals and make comments as specified in Section 01 33 00.

7. Job Conditions

- 7.1. Ensure that Work proceeds under conditions meeting specified environment and job safety requirements
- 7.2. Ensure that protection of adjacent property and the Work is adequately provided and maintained to meet specified requirements.

8. Product Delivery, Storage And Handling

- 8.1. Site has limited spaces for storage, only delivery of materials agreed upon by the Construction Manager will be allowed. Comply with Construction Manager's allocations. Any requirement for modifications to the building in order to allow delivery and storage of the materials to complete this work is the responsibility of the contractor.
- 8.2. Schedule delivery of products & removal of material with Construction Manager.
- 8.3. Make available areas for storage of products and construction equipment to meet specified requirements, and to ensure a minimum of interference with progress of the Work and relocations.
- 8.4. Trade Contractor to provide flag persons, traffic signals, barricades and Flares/lights/lanterns as required to perform the Work and to protect the public.
- 8.5. Material and Waste - Deliveries and Removals - Must be coordinated to be completed 30 minutes after school dismissal where applicable.

END OF SECTION 01 11 41

SECTION 01 31 19 – PROJECT MEETINGS

1. Pre-Award Meeting

- 1.1.** A Pre-award meeting will be held at which time the following will be addressed:
 - 1.1.1.** Owner and HRSB's functions.
 - 1.1.2.** The Consultant and the Consultant's functions.
 - 1.1.3.** The General Contractor and the General Contractor's functions.
 - 1.1.4.** Documentation requirements from the General Contractor.
 - 1.1.5.** Obligees for Performance and Payment Bonds from Sub-contractors.
 - 1.1.6.** Progress Claims.
 - 1.1.7.** CO's & CCO's.
 - 1.1.8.** Construction Schedule.
 - 1.1.9.** Project Start-up.
 - 1.1.10.** Job Meetings.
 - 1.1.11.** Superintendent – General Contractor's Representative.
 - 1.1.12.** Design / Administration authority.
 - 1.1.13.** Owner's Representative.
 - 1.1.14.** Special Consultants.
 - 1.1.15.** Quality of Workmanship.
 - 1.1.16.** Accountability.
 - 1.1.17.** Harmonized Sales Tax.
 - 1.1.18.** Contract Close-out Documentation.

2. Preconstruction Meeting

- 2.1.** Within fifteen (15) days after award of Contract, arrange a meeting between the, Consultant, Subcontractors, Project Superintendents, Inspection and Testing Company Representatives, and representatives of others whose coordination is required during construction.
- 2.2.** Discuss at the meeting the means by which full cooperation and coordination of the participants during construction can be achieved.
- 2.3.** Document the responsibilities and necessary activities of the participants during construction as discussed, and distribute to each participant.
- 2.4.** Establish procedures for maintenance and completion of Project record drawings specified in Section 01 77 00.
- 2.5.** Review and establish methods of maintaining life safety and egress for the school occupants. Communicate these methods thoroughly with the School Principal.

3. Progress Meeting

- 3.1.** Invite representatives of HRSB, to attend twice monthly site meetings called by the Contractor during the progress of the Work.

- 3.2. Inform HRSB of each meeting and of proposed agenda a minimum of five (5) days before meeting.
- 3.3. Submit proposed schedule of site meetings to Engineer and Owner.
- 3.4. Record, prepare and distribute minutes of each meeting to HRSB and to each other participant within 72 hours of meeting.
- 3.5. Ensure that all representatives who attend meetings have the authority to conduct business on behalf of firms they represent.
- 3.6. Details of Progress Meetings to be discussed at the project start-up meeting.

4. Suggested Agendum (Preconstruction Meeting)

- 4.1. Distribution and discussion of:
 - 4.1.1. List of major subcontractors and suppliers.
 - 4.1.2. Projected Construction Schedules.
- 4.2. Critical work sequencing.
- 4.3. Major equipment deliveries and priorities.
- 4.4. Project Coordination:
 - 4.4.1. Designation of responsible personnel.
- 4.5. Procedures and Processing of:
 - 4.5.1. Field decisions
 - 4.5.2. Proposal requests
 - 4.5.3. Submittals
 - 4.5.4. Change orders
 - 4.5.5. Applications for Payment.
- 4.6. Adequacy of distribution of Contract Documents.
- 4.7. Procedures for maintaining Record Documents.
- 4.8. Use of premises:
 - 4.8.1. Office, work and storage areas.
 - 4.8.2. Owners requirements.
- 4.9. Construction facilities, controls and construction aids.
- 4.10. Safety/Tool Box Meetings.
- 4.11. Security procedures.
- 4.12. Housekeeping procedures.
- 4.13. Egress/life safety procedures

5. Suggested Agendum (Progress Meetings)

- 5.1. Review and approval of minutes of previous meeting.
- 5.2. Safety meeting minutes.
- 5.3. Review of work progress since previous meeting.
- 5.4. Field observations, problems, conflicts.

- 5.5. Problems which impede Construction Schedule.
 - 5.6. Review of off-site fabrication, delivery Schedules.
 - 5.7. Corrective measures and procedures to regain projected schedules.
 - 5.8. Revisions to Construction Schedules.
 - 5.9. Maintenance of quality standards.
 - 5.10. Pending changes and substitutions and effect on Construction Schedule.
 - 5.11. Other Business.
-
- 6. Attend, with representatives of HRSB twice monthly meetings with the School Administration to review construction activities and concerns of Building Occupants.
 - 7. Quarterly meetings with Contractor and School Board / User during Warranty Period including major sub-trade contractors.
 - 8. Dates for meetings will be set at time of completion.

END OF SECTION 01 31 19

SECTION 01 33 00 – SUBMITTAL PROCEDURES

1. General Requirements

- 1.1. Make submittals specified in this Section to Consultant unless otherwise specified, with additional submissions made, in manner he directs, to other parties involved with construction of the Project as their interests are concerned. These parties are, but shall not be restricted to, consultants, jurisdictional authorities, and Subcontractors whose Work must be coordinated with Work related to Submittals.
- 1.2. Ensure that submissions are made to allow sufficient time for review without the construction schedule being delayed.

2. Document Submissions Required

- 2.1. At Commencement of Contract:
 - 2.1.1. Performance and Payment Bonds.
 - 2.1.2. Public Liability and Property Damage Insurance Certificates.
 - 2.1.3. List of Subcontractors by firm name.
 - 2.1.4. Construction Schedule and other required schedules and estimates.
 - 2.1.5. Site Specific Safety Plan/Safety Policy.
 - 2.1.6. Workers' Compensation Board status.
- 2.2. During Construction:
 - 2.2.1. Bi-weekly progress reports.
 - 2.2.2. Job meeting reports and minutes.
 - 2.2.3. Updated construction schedules.
 - 2.2.4. Shop drawings as required.
 - 2.2.5. Inspection and test reports.
 - 2.2.6. Daily communication of Hot Work Permits as needed.
- 2.3. Submissions at completion of Work are specified in Section 01 77 00, Contract Closeout.

3. Administrative

- 3.1. Submit to Consultant submittals listed for review. Submit promptly and in orderly sequence to not cause delay in Work. Failure to submit in ample time is not considered sufficient reason for extension of Contract Time no claim for extension by reason of such default will be allowed.
- 3.2. Do not proceed with Work affected by submittal until review is complete.
- 3.3. Present shop drawings, product data, samples and in Imperial units.
- 3.4. Review submittals prior to submission to Consultant. This review represents that necessary requirements have been determined and verified, or will be, and that each submittal has

been checked and co-ordinated with requirements of Work and Contract Documents. Submittals not stamped, signed, dated and identified as to specific project will be returned without being examined and considered rejected.

- 3.5. Notify Consultant in writing at time of submission, identifying deviations from requirements of Contract Documents stating reasons for deviations.
- 3.6. Verify field measurements and affirm that affected adjacent work is co-ordinated.
- 3.7. Contractor's responsibility for errors and omissions in submission is not relieved by Consultant's review of submittals.
- 3.8. Contractor's responsibility for deviations in submission from requirements of Contract Documents is not relieved by Consultant's review.
- 3.9. Keep one review copy of each submission on site.

4. Construction Schedules

- 4.1. Submit proposed construction schedule at beginning of Project, as specified in Project Documents.
- 4.2. As construction progresses, submit up-dated construction schedules as specified in Project documents.

5. Shop Drawings And Product Data

- 5.1. The term "shop drawings" means drawings, diagrams, illustrations, schedules, performance charts, brochures and other data which are to be provided by Contractor to illustrate details of a portion of Work.
- 5.2. Submit drawings stamped and signed by professional consultant registered or licensed in Province of Nova Scotia of Canada.
- 5.3. Indicate materials, methods of construction and attachment or anchorage, erection diagrams, connections, explanatory notes and other information necessary for completion of Work. Where articles or equipment attach or connect to other articles or equipment, indicate that such items have been co-ordinated, regardless of Section under which adjacent items will be supplied and installed. Indicate cross references to design drawings and specifications.
- 5.4. Allow seven (7) days for Consultant's review of each submission. Do not proceed with work involving relevant products until completion of shop drawing review.
- 5.5. Adjustments made on shop drawings by Consultant are not intended to change Contract Price. If adjustments affect value of work, state such in writing to Consultant prior to proceeding with work.

- 5.6. Make changes in shop drawings as Consultant may require, consistent with Contract Documents. When resubmitting, notify Consultant in writing of revisions other than those requested.

Accompany submission with transmittal letter, in duplicate, containing:

- 5.6.1. Date
 - 5.6.2. Project title and number
 - 5.6.3. Contractor's name and address
 - 5.6.4. Identification and quantity of each shop drawing, product data and sample.
 - 5.6.5. Other pertinent data.
- 5.7. Submission to include:
- 5.7.1. Date and revision dates.
 - 5.7.2. Project title and number.
 - 5.7.3. Name and address of:
 - 5.7.3.1. Subcontractor.
 - 5.7.3.2. Supplier.
 - 5.7.3.3. Manufacturer.
 - 5.7.4. Contractor's stamp, signed by Contractor's authorized representative certifying approval of submissions, verification of field measurements and compliance with Contract Documents.
 - 5.7.5. Details of appropriate portions of Work as applicable:
 - 5.7.5.1. Fabrication.
 - 5.7.5.2. Layout, showing dimensions, including identified field dimensions, and clearances.
 - 5.7.5.3. Setting or erection details.
 - 5.7.5.4. Capacities.
 - 5.7.5.5. Performance characteristics.
 - 5.7.5.6. Standards.
 - 5.7.5.7. Relationship to adjacent work.
- 5.8. After Consultant's review, distribute copies.
- 5.9. Submit for review one electronic copy in PDF file format of shop drawings for each requirement requested in specification Sections and as Consultant may reasonably request.
- 5.10. Submit electronic copies of product data sheets for brochures for requirements requested in specification Sections and as requested by Consultant where shop drawings will not be prepared due to standardized manufacture of product.
- 5.11. Submit electronic copies of test reports for requirements requested in specification Sections and as requested by Consultant.

- 5.11.1. Report signed by authorized official of testing laboratory that material, product or system identical to material, product or system to be provided has been tested in accord with specified requirements.
- 5.11.2. Testing must have been within three (3) years of date of contract award for project.
- 5.12. Documentation of testing and verification actions taken by manufacturer's representative to confirm compliance with manufacturer's standards or instructions.
- 5.13. Delete information not applicable to project.
- 5.14. Supplement standard information to provide details applicable to project.
 - 5.14.1. If upon review by Consultant, no errors or omissions are discovered or if only minor corrections are made, copies will be returned and fabrication and installation of work may proceed. If shop drawings are rejected, noted copy will be returned and resubmission of corrected shop drawings, through same procedure indicated above, must be performed before fabrication and installation of work may proceed.
 - 5.14.2. Without restricting generality of foregoing, Contractor is responsible for dimensions to be confirmed and correlated at job site, for information that pertains solely to fabrication processes or to techniques of construction and installation and for coordination of work of sub-trades.
- 5.15. Shop Drawings are specified for submission under the following:
 - Section 03 20 00 Concrete Reinforcement
 - Section 05 12 23 Structural Steel
 - Section 05 31 00 Steel Deck
 - Section 05 50 00 Metal Fabrications
 - Section 06 10 11 Rough Carpentry
 - Section 06 40 00 Architectural Woodwork
 - Section 07 41 43 Aluminum Composite Panels
 - Section 07 46 13 Preformed Metal Siding
 - Section 07 55 00 Modified Bitumen Roofing System & Flashing
 - Section 07 84 00 Fire Stopping and Smoke Seals
 - Section 08 11 14 Steel Doors & Frames
 - Section 08 11 16 Aluminum Doors & Frames
 - Section 08 14 10 Wood Doors
 - Section 08 50 50 Aluminum Windows
 - Section 08 62 11 Vinyl Windows
 - Section 08 71 10 Door Hardware
 - Section 09 22 16 Non-Load Bearing Wall Framing
 - Section 09 30 13 Ceramic Tile
 - Section 10 11 13 Communication Boards

##3857 RECLADDING – TERENCE BAY ELEMENTARY

Section 10 11 23 Tackboards
Section 10 14 53 Traffic Signs
Section 10 28 10 Toilet & Bath Accessories
Section 10 50 00 Miscellaneous Specialties
Section 11 40 11 Food Services Catalogued & Custom Equipment
Section 12 21 13 Horizontal Blinds
Section 12 21 16 Roller Shades
Section 14 42 13 Wheelchair Platform Lift

All pre-manufactured Mechanical & Electrical items as noted in Mechanical & Electrical Divisions.

6. SAMPLES

- 6.1. Submit for review samples in duplicate as requested in respective specification Sections, as requested by the Consultant. Label samples with origin and intended use.
- 6.2. Deliver samples prepaid to Consultant's business address.
- 6.3. Notify Consultant in writing, at time of submission of deviations in samples from requirements of Contract Documents.
- 6.4. Adjustments made on samples by Consultant are not intended to change.
- 6.5. Make changes in samples which Consultant may require, consistent with Contract Documents.
- 6.6. Reviewed and accepted samples will become standard of workmanship and material against which installed work will be verified.
- 6.7. Samples are specified for submission under the following Sections:

Section 07 41 43 Aluminum Composite Panels
Section 07 46 13 Preformed Metal Siding
Section 08 14 10 Wood Doors
Section 08 50 50 Aluminum Windows
Section 09 30 13 Ceramic Tile
Section 09 51 13 Acoustical Ceiling Units
Section 09 65 19 Resilient Tile Flooring
Section 12 21 13 Horizontal Blinds
Section 12 21 16 Roller Shades

Refer to Mechanical & Electrical Divisions for sample requirements in those Trades.

7. Record Drawings

- 7.1. Record, as the Work progresses, changes and deviations in the location of Work concealed by the finished Work, and such other approved changes that occur during progress of Work, to ensure that an accurate record is provided for future maintenance and alterations.

- 7.2. White prints will be provided by the School Board for use in preparing record drawings. Record changes in the Work on these prints in red ink.
- 7.3. Dimension location of concealed Work in reference to building walls, and elevation in reference to floor elevation. Indicate at which point dimension is taken to concealed Work. Dimension all terminations and offsets of runs of concealed work.
- 7.4. Record work constructed differently than shown on Contract Documents, changes in the work caused by site conditions, by Owner, Consultant, Contractor and Subcontractor originated changes, and by site instructions, supplementary instructions, field orders, change orders, addenda, correspondence and directions of jurisdictional authorities.
- 7.5. Record location of mechanical and electrical services, piping, valves, conduits, pull boxes, junction boxes and similar work not clearly in view, and position of which is required for maintenance, alteration work and future additions. Do not conceal critical work until its location has been recorded.
- 7.6. Identify record drawings as a "Project Record Copy". Maintain in good condition, do not use for construction purposes and make available to Consultant at all times.
- 7.7. Submit record drawings at completion of Work. Final acceptance of the Work will be predicated on receipt and approval of record drawings.

8. Extra Stock

- 8.1. Supply extra stock at completion of Project as specified in other Sections of the Project Manual.
- 8.2. Deliver extra stock as directed by the Architect to location he designates.
- 8.3. Extra stock is specified to be supplied in the following Sections:

Section 09 30 13 Ceramic Tile

Section 09 51 13 Acoustical Ceiling Units

Section 09 65 19 Resilient Tile Flooring

Section 09 91 23 Painting

Refer to Mechanical & Electrical Divisions for Extra Stock requirements in those Trades.

9. Maintenance Manual & Operating Instructions

- 9.1. Submit three (3) copies of Maintenance Manual with application for completion certificate.
- 9.2. Include in Maintenance Manual one (1) copy of each final approved shop drawing issued for Project on which have been recorded changes made during fabrication and installation caused by unforeseen conditions.
- 9.3. Submit extended guarantees together in one (1) report binder.
- 9.4. The Manuals shall:

- 9.4.1. Consist of a hard-cover, black, vinyl-covered, loose-leaf, letter-size binder.
- 9.4.2. Have a title sheet, or sheets preceding data on which shall be recorded Project name, Project number, date, list of contents, and Contractor's and Subcontractors' names.
- 9.4.3. Be organized into applicable Sections of Work with each Section separated by hard paper dividers with plastic covered tabs marked by Section.
- 9.4.4. Contain only typed or printed information and notes, and neatly drafted drawings.
- 9.4.5. Contain maintenance and operating instructions on all building, and mechanical and electrical equipment.
- 9.4.6. Contain maintenance instructions as specified in various Sections.
- 9.4.7. Contain brochures and parts lists on all equipment.
- 9.4.8. Contain sources of supply for all proprietary products used in the Work.
- 9.4.9. Contain lists of supply sources for maintenance of all equipment in Project of which more detailed information is not included above.
- 9.4.10. Contain finished hardware schedule.
- 9.4.11. Contain charts, diagrams and reports specified in Mechanical & Electrical Divisions.

10. Extended Warranties

- 10.1. Submit the extended warranties listed in this Article and as specified in each applicable Section of this Project Manual.
- 10.2. Extended warranties shall commence on termination of the standard one-year warranty granted in this Contract.
- 10.3. Submit each extended warranty on a standard Form of Warranty, a sample of which is included in this Section.
- 10.4. Secure each extended Warranty by a Maintenance Bond in an amount indicated.
- 10.5. Submit extended warranties for:

Section 06 40 00 Architectural Woodwork – extended 4 years

Section 07 41 43 Aluminum Composite Panels – extended 10 years (panel finish)

Section 07 55 00 Modified Bitumen Roofing System & Flashing:

- 2 year CRCA materials and workmanship against leaks and blow off
- 10 year material warranty the membrane will perform as a roofing material
- 1 year CRCA warranty against defects of materials and workmanship for the sheet metal work.

Section 07 92 10 Joint Sealants – extended 5 years

Section 08 11 16 Aluminum Doors & Frames – extended 4 years

Section 08 14 10 Wood Doors – extended 4 years

Section 08 50 50 Aluminum Windows – extended 4 years

##3857 RECLADDING – TERENCE BAY ELEMENTARY

Section 08 62 11 Vinyl Windows – extended 5 years
Section 08 71 10 Door Hardware – various, refer to that Section
Section 09 30 13 Ceramic Tile – extended 4 years
Section 09 51 13 Acoustical Ceiling Units – extended 4 years
Section 09 65 19 Resilient Tile Flooring – extended 4 years
Section 10 11 13 Communication Boards – extended 24 years
Section 10 11 23 Tackboards – extended 9 years
Section 12 21 13 Horizontal Blinds – extended 5 years
Section 12 21 16 Rollers Shades – extended 5 years
Section 14 42 13 Platform Lift – extended 5 years
Refer to Mechanical & Electrical Divisions for extended Warranty requirements in those trades.

11. Inspection Laboratory Reports

- 11.1.** Submit copies of inspection and test reports obtained by the Contractor and Subcontractors for their Work or for Jurisdictional Authorities, if requested by Consultant.
- 11.2.** Submit reports in accordance with requirements specified in Section 01 41 00.

12. Documentation On Suppliers & Manufacturers

- 12.1.** Provide information under headings identifying the following: Associated Technical Section, Manufacturer, Supplier, Contact Name, Phone Numbers.

SAMPLE FORM OF WARRANTY FOLLOWS THIS PAGE

Sample Form for Warranty

Date

Client

Project

.....

Warranty

(title of work)

We hereby undertake to warrant all materials supplied and installed under our Contracts and include the providing of necessary materials and labour to cover the result of faulty materials or workmanship. Upon written notification from Client or the Architect that the above work is defective any repair or replacement work required shall be to the Architect's satisfaction at no cost to the Client. This Warranty shall not apply to defects caused by the work of others, maltreatment of materials, negligence or Acts of God. This Warranty shall remain in effect for the total period from the acceptance of the Work to (...date....), irrespective of the date of completion or the beneficial use by the Owner.

Signature

Authorized Signing Officer

Name of Firm

Address

END OF SECTION 01 33 00

SECTION 01 35 13 – APPENDIX A - SPECIAL PROJECT PROCEDURES

1. Introduction

- 1.1.** School construction, renovation and maintenance projects are scheduled every year as a normal and necessary course of business by operations departments in each Nova Scotia School Board. Building modifications, repairs and additions/demolitions to buildings may impact the school environment without appropriate controls. With increased controls based primarily on the CSA standards implementation, proper scheduling and clear communication on adequate controls can be put into place to eliminate/minimize the impact to all occupants.
- 1.2.** Projects of this nature may generate varying levels of dusts, noises and odors. It is possible, unknown/unforeseeable environmental contaminants, such as spills, mould, fumes, lead or asbestos exposure maybe identified.
- 1.3.** To successfully complete work within the school environment, it is necessary to plan and implement appropriate containment and control strategies. This document is developed to provide a minimum standard for contaminant controls for various types of projects in schools. These standards are in addition to and should complement all legislated protocols for working with regulated materials such as asbestos, lead paints, PCB's etc.
- 1.4.** Executing a successful project will depend primarily on clear, concise communication. This may involve a number of parties (Project Manager, Operations staff, School Administration and Health & Safety staff and Joint Occupational Health & Safety Committee).

2. Communication Plan

- 2.1.** The most critical element of any project management plan is effective communication between all stakeholders. Communication between the Operations project manager/supervisor, the contractor and school administrators before the start of a project is very important. This meeting is meant to explain the scope, schedule and risk assessment for the project. The meeting will also help establish clear expectations when managing planned and unplanned exposure risks associated with contaminant controls.
- 2.2.** The communication plan shall include:
 - 2.2.1.** A description of potential contaminants, which may include but is not limited to:
 - 2.2.1.1.** Particulates (dirt, concrete/silica, steel, fiberglass, wood dust, ash, cellulose, etc.)
 - 2.2.1.2.** Moisture: external water infiltration, internal system leaks (domestic water, sanitary, storm, sprinkler)
 - 2.2.1.3.** Noise from equipment/tool operation,
 - 2.2.1.4.** Fumes/odors from equipment exhaust, boiler exhaust, septic waste, chemical/adhesives, etc.
 - 2.2.1.5.** Hazardous materials including, asbestos, PCB, mercury, lead, fuel oil, fungi/mould, etc.
 - 2.2.1.6.** Excessive heat/cold

- 2.2.2. A description of the control measure which may include but not be limited to:
 - 2.2.2.1. Isolation within an enclosure (water, noise, hazardous materials)
 - 2.2.2.2. Ventilation and filtration
 - 2.2.2.3. Dehumidifiers/blowers (moisture)
 - 2.2.2.4. Personal protective equipment
 - 2.2.2.5. Schedule outside or inside school hours
 - 2.2.2.6. Sound dampeners
 - 2.2.2.7. Monitoring
 - 2.2.2.8. Security
- 2.2.3. Other Hazards created by the work, including but not limited to fire safety and the need to alter fire safety plans.
- 2.3. For small routine work orders the communication plan may only involve one tradesperson and the school principal or designate. This communication is equally as important for management of contaminant controls.

3. Contaminant Control Management

- 3.1. Regardless of the contaminant or control measure used, the following procedures shall apply for every project:
 - 3.1.1. Every project, including all routine work requests, shall be assessed, as per this document, by appropriate personnel for potential contaminant risk.
 - 3.1.2. Clear lines of communication must be established between project personnel, site supervisor or project manager and the school administration.
 - 3.1.3. Control strategies as per this document, shall be, communicated to workers as well as the site JOHSC and implemented prior to starting the work.
 - 3.1.4. Where isolation is used as a control, all entry points must be clearly posted to describe the purpose of the enclosure and limitations of access.
 - 3.1.5. During the execution of the project, the control measures must be regularly inspected and maintained before the start of each work shift, and throughout the shift as required.
 - 3.1.6. A process for stop work and remediation orders must be established to ensure the project manager; site supervisor and school administrator have a means to cease project operations when a contaminant control breach may impact the school environment. Breached control measures must be reported immediately to the board project manager upon discovery. He/she will be responsible to communicate to the school principal or designate. Work shall be stopped immediately until the control measures are re-established.
 - 3.1.7. Access to the controlled work site is only permitted by authorized personnel. The project supervisor or designate shall determine appropriate personal protective equipment (PPE) and necessary worker orientation.

4. Particulate Control

- 4.1.** Exposure to minimal levels of dust is a normal condition in most outdoor and indoor environments and is typically controlled inside a building through building ventilation, filtration and routine housekeeping measures. However, as noted, construction projects generally create elevated dust levels in work areas, whether inside or outside of a building.
- 4.2.** Operational Services Managers must ensure maintenance staff and contracted service providers implement dust control measures appropriate for the type and scope of work being performed. This will include assessing the type and amount of dust being created as well as the location of the work being conducted.
 - 4.2.1.** Interior Construction Projects:
 - 4.2.2.** Construction projects may be described as projects that may include window replacement, wall creation/demolition, etc.
- 4.3.** As a minimum for these types of construction projects, all interior entry points into a construction zone must be effectively sealed. The barrier must prevent contaminants from the work area to be distributed to other areas of the school. Appropriate signage must be posted to indicate only authorized persons are permitted access.
- 4.4.** Entrance design could range from a two flap plastic tarp door to a fully constructed sealed entry door with negative hepa-filtered ventilation on the construction side of the barrier.
- 4.5.** Exterior Construction Projects:
 - 4.5.1.** Exterior work shall be performed so as not to affect the safety of building occupants. It will also provide controls to avoid impact to adjacent properties. Depending up on the results identified in the risk assessment, at a minimum consideration must be given to prevent dust from entering into the school environment. This may be controlled through isolation, dampening application, closing building AHU and window/door openings.

5. Noise Control

- 5.1.** Hearing plays an essential role in communication, speech and language development and learning within a school environment. During construction the contractor is responsible for ensuring acceptable noise levels will be adhered to for school board staff and students within the building. Noise related to a project may prove to be very distracting for staff and students. To minimize distractions and interruptions in student learning the following are important to consider:
 - 5.1.1.** Contractors are responsible to ensure appropriate noise control measures are taken
 - 5.1.2.** "No work" periods may need to be incorporated into construction schedules
 - 5.1.3.** Work causing a noise disruption may need to take place during unoccupied times and/or during pre-determined acceptable times of the day (i.e. before and after class times)

- 5.1.4. It may be necessary for the School Administrator to make a request to the Board Project Manager or the Contractor to exclude undertaking certain noisy activities during particular periods and/or activities.

6. Moisture Control

- 6.1. Moisture levels are to be controlled during construction and maintenance activities. Moisture levels above normal may impact the air in the room and/or building and may also penetrate building materials giving the potential to lead to mould growth.
- 6.2. Certain activities (i.e. tape and mud of drywall, painting, pressure washing, concrete cutting with water or other water based dust-suppression) introduce high amounts of moisture into the room environment and ventilation and or drying is required to control local moisture.
- 6.3. An enclosure properly set-up to contain other contaminants will similarly contain/control high levels of airborne moisture. A wet-vac should be available on-site for activities which have a risk of water spillage of more than 5 gallons at any instance.
- 6.4. Standing and or stagnate water must be avoided on construction sites, for a number of reasons, including, but not limited to; insects breed in these bodies of water, the water may give off odours, it is a nuisance to walk through, and it may be an ice hazard in cold weather.
- 6.5. It is important that all water leaks and flooding are reported immediately to the board's project manager and building supervisor. Where works to existing "plumbing" is to occur the water lines (potable, heating, fire suppression) must be isolated and drained (de-energized/de-pressurized) following Lock Out - Tag Out procedure. Adequate supplies such as buckets and absorbents should be present when drains are not available to drain a line.
- 6.6. When an interruption to the water supply, potable or service, is to occur then the "owner's representative" and building supervisor should be notified 24 hours in advance. Bottled water provision may be required.
- 6.7. Materials used in the construction and or maintenance activities are to be stored in dry areas. The introduction of materials to the activities with moisture levels above the acceptable (XXX%)CNBC states for wood, on dry weight basis, a max of 19%, I can't find info on drywall but assume it is much lower range is prohibited as these materials are highly susceptible to colonization by mould spores.

7. Fumes

- 7.1. Fumes may be produced on a project site for a variety of reasons such as use of motorized equipment, off gassing of sealants, adhesives and finish products, cutting/torching processes, exposure of sanitary systems, process ignition gases such as propane and acetylene, proximity of project temporary washrooms, radon, etc.
- 7.2. The impact of fumes on occupants may range from discomfort to health risk, to life safety risk.

- 7.3. The project manager or supervisor must ensure that all potential fume sources are identified and remedial or control measures included in the scope of work by the contractor.
- 7.4. Monitoring equipment may be required to determine for example radon exposure or safety of confined space access.

8. Activity Assessment

- 8.1. Activities that may produce contaminants which require control may be considered as low, medium and high impact.
- 8.2. Low impact activities include routine maintenance and repairs that may create localized dust or odors or brief periods of noise which are not considered harmful to occupants but may be a nuisance which requires minimal control. These may include activities such as opening ceiling tiles or gyproc walls, replacing a plumbing fixture, paint touch ups, drilling through a wall, etc.
- 8.3. Medium impact activities include larger repair jobs or longer duration projects that will create more wide spread levels of contaminant which must be controlled to prevent exposure to building occupants. Boiler cleaning, ceiling replacement, long periods of hammer drilling, etc.
- 8.4. High impact activities include large demolition and construction projects, or jobs with exposure to contaminants that are a risk to health or life safety such as asbestos remediation, mould abatement, lead paint clean up, etc.

9. Hazard Assessment

- 9.1. A hazardous assessment is required to be completed for each job to ensure hazards are identified and corresponding controls are implemented. Depending upon the circumstances at the site it may be necessary to upgrade and/or add other precautions.
- 9.2. Determine the most appropriate hazard classification and apply the corresponding protocols. The attached hazard assessment identifies the minimum controls that must be in place during the corresponding activities. Depending on the specific circumstances at a site further controls may be required. When the hazards are deemed to be in the C or F category the form including specific controls must be submitted to the board for review, prior to commencing work. The contractor may still be required to complete their own hazard assessment of the job/work.

10. Contaminant Controls Procedure for initiating work for all Contaminant Controls:

10.1. Contaminant Control I

- 10.1.1. The tradesperson or project manager for the board will discuss the details, including the scope and any impacts of the job/project with the principal.

- 10.1.2. Ensure fire exiting requirements and life safety systems are addressed or adequate mitigating plans are implemented for the building, construction staff and building occupants.
- 10.1.3. Presence of lead paint or ACM's (Asbestos Containing Materials) must be determined prior to the start of any job. Specific protocols or Codes of Practice may apply.
- 10.1.4. Consideration will be given for work that is anticipated to generate significant noise, odours or VOC's (Volatile Organic Compounds) and this will be scheduled outside of school hours or during times when the noise will not disrupt occupant activities. This will require coordination with the Principal.
- 10.1.5. The work area shall be isolated where possible. This may be achieved at varying levels, by closing doors and opening outside windows for ventilation or by installing appropriate hoarding and negative pressure units to ensure contaminants are not circulated throughout the school causing further health and safety concerns.
- 10.1.6. Dust shall be minimized during the activity. When drilling, sanding or cutting is taking place, wetting the area may be necessary to reduce dust.
- 10.1.7. Good housekeeping practices shall be maintained at all times on the work site. Bag and remove dust and debris from the building as soon as possible.
- 10.1.8. Possible environmental impacts shall be managed and minimized. If work uncovers environmental contaminants or suspected contaminants such as oil spills (current or historic) or potentially friable asbestos materials (check the school asbestos audit) that may be disturbed, this information shall be brought to the attention of the Board's employee responsible for the project so that appropriate actions can be taken.
- 10.1.9. When the activity is completed the work area shall be inspected and cleaned. Dust and debris shall be removed from the area and all efforts will be made to return items to their pre-maintenance activity location.
- 10.1.10. The Principal shall be notified that the work is completed.
- 10.2. **Contaminant Control II** - All Contaminant Control I measures shall apply, as well as;
 - 10.2.1. Cover furniture, bookshelves and teaching materials with plastic sheets.
 - 10.2.2. Water misting while performing dust generating activities may be required.
 - 10.2.3. Seal un-used doors. Seal wall penetrations, electrical outlets, or any other source of air leaks in the construction area.
 - 10.2.4. Seal exhaust air vents in construction area and open the windows. If possible shut down air handling system in the area for duration of project.
 - 10.2.5. A walk out mat at exterior of exit door to trap dust may be required.
- 10.3. **Contaminant Control III** - All Contaminant Control I and II measures shall apply, as well as;
 - 10.3.1. Install an impermeable dust barrier from the true ceiling to the floor consisting of two layers of 6 mil fire retardant polyethylene or solid wall and sealed door. The wall shall remain in place until the job is finished and the clean-up is completed.

- 10.3.2. Seal all wall penetrations
- 10.3.3. Seal off all return and supply air handling ducts and close all windows.
- 10.3.4. Turn off the air handling system in the area of construction.
- 10.3.5. Maintain negative air pressure in the construction area using HEPA filter equipped exhaust ventilation. The pressure differential between the project area of contamination and the building's occupied areas shall be demonstrable by a means approved by the Board employee responsible for the project.
- 10.3.6. Ensure that the air is exhausted directly outside and away from intake vents.
- 10.3.7. Vacuum all horizontal surfaces including drop cloths with a hepa vacuum.
- 10.3.8. Remove drop clothes
- 10.3.9. Vacuum again all horizontal surfaces with HEPA Vacuum.
- 10.3.10. Restore ventilation.
- 10.3.11. Remove enclosure and equipment.
- 10.4. **Control IV: (External Work)**
 - 10.4.1. External work may impact building interior or occupants.
 - 10.4.2. To reduce the impact to building interior or occupants, it may be necessary to contain the work area from impacting building interior. This may include closing or opening windows, tarping ceilings to capture debris or water, temporary relocation of occupants or ventilation controls.
 - 10.4.3. The job supervisor shall consider weather conditions and forecast to reduce the effect of any weather impacts to the building materials or building occupants.
 - 10.4.4. It may be necessary to use protective tarps and ground cover sheets below equipment and work areas to contain building debris such as paint chips, materials, dust or oil from equipment.
 - 10.4.5. When the job is completed and the tarps have been lifted, inspect the ground around the job for debris and clean as necessary.

Fire Protection

10.5. Type V: General Fire Protection

- 10.5.1.** Ensure fire exiting requirements and life safety systems are addressed or adequate mitigating plans are implemented for the building, construction staff and building occupants. Staff must be aware of temporary modifications to fire safety plans.
- 10.5.2.** MSDSs for all materials to be used must be reviewed and available on site.
- 10.5.3.** Construction materials stored outside must be a minimum distance of ten feet from the building and be in a secured area.
- 10.5.4.** Flammable or Combustible liquids must be stored as per Fire Code requirements. All flammable and combustible liquids or materials must be kept in a secure area at all times.

10.6. Control VI: Fire Protection (minor hot work) - All Contaminant Control V shall apply as well as;

- 10.6.1.** Notify the Principal that a risk of fire has increased and the area in which the hot work will occur.
- 10.6.2.** Refer and implement the board's hot work permit process. At a minimum the following should be considered;
 - 10.6.2.1.** Sweep the work area and remove all unnecessary materials in the vicinity; particularly all combustible and flammable materials and liquids shall be removed from the area (35 feet).
 - 10.6.2.2.** Have an appropriate size fire extinguisher available.
 - 10.6.2.3.** Inspect the work location for areas (such as a hole in the wall) where hot material or sparks could fall and smolder and close them off so that any hot debris can only fall within your field of view.
 - 10.6.2.4.** If it is possible that the flame will go past the object being welded or soldered and excessively heat a flammable or combustible material then either protect that material with a non-flammable material or wet the material and keep it wetted during the use of heat or grinding.
 - 10.6.2.5.** Remain in the area while the joint and/or heated materials cool to room temperature (ambient) while checking for the smell or appearance of smoke in the area.
 - 10.6.2.6.** Stay in the area for at least 2 hour and then re-inspect for any smell or appearance of smoke.
 - 10.6.2.7.** Ask another staff person to inspect the area for the smell or appearance of smoke. Record who you asked to do the final inspection.
- 10.6.3.** Type VII: Fire Protection (hot work w fire watch) - All Contaminant Control V and VI shall apply as well as;
- 10.6.4.** Notify the Principal that a risk of fire has increased and the area in which the hot work will occur. If any life safety system components (sprinkler, detectors, fire alarms) are not functioning, hot work should not proceed until these systems are

functioning unless fire watch procedures for life systems are followed. See Activation of Fire Watch for Life Safety Systems checklist. Appendix...XX

- 10.6.5.** Refer and implement the board's hot work permit process. At a minimum the following should be considered;
- 10.6.5.1.** Cover all floor openings with fire stop material. Seal duct work openings with metal covers or blankets and close all doors.
 - 10.6.5.2.** Ensure that there are no potentially explosive atmospheres in the area.
 - 10.6.5.3.** Hot work on vessels, pressure tanks or boilers, use only contractors who are qualified by nationally or internationally recognized boiler and pressure vessel code.
 - 10.6.5.4.** Notify the local fire department of the type of work and the work schedule.
 - 10.6.5.5.** Before hot work is started, designate one employee responsible to complete the fire watch: while work is in progress, during lunch breaks and other breaks and for one hour after all flames are extinguished for the day and monitor the area for an additional two hours. After three hours after the last flame has been extinguished, have a second employee do a final survey of the area for smells or evidence of smoldering or fire and record the inspection.

APPENDIX
Fire Watch Activation Checklist

1. Documentation (identify locations to be checked on an hourly basis, provide contact information for relevant board staff and outside agencies} Board provided template to be used for documentation.
2. Procedure reviewed with Custodian or individual responsible for fire watch. Any high risk areas shall be identified to be highlighted on the documentation page and checked during the rounds.
3. Staff working in the building have been notified of the Fire Watch and that they are responsible to monitor areas for signs of fire or smoke and have been reminded of required actions to take according to the school fire safety plan.
4. Staff responsible for fire watch have been trained in how to use a fire extinguisher. (PASS)
5. Staff responsible for the fire watch have a means of communication (cell phone or walkie-talkies)
6. Staff responsible for the fire watch are aware of the procedure for initiating fire alarm and what systems are functioning. i.e. systems (sprinklers, alarm panel or if school has monitoring company or if calling 911 is required)
7. The School Insurance Program (SIP) Emergency Information Line has been notified 1-902-448-2840
8. All relevant information has been documented in the school's fire books. Including date, time and reason for fire watch.

Fire Watch De-Activation Checklist

1. Document the date, time and actions taken to remedy the deficiency requiring the fire watch.
2. School Insurance Program (SIP) has been notified
3. Copy of the Fire Watch documentation is kept in the fire book and the original is sent to the HRSB Project Representative.

END OF SECTION 01 35 13

SECTION 01 35 29 - OCCUPATIONAL HEALTH & SAFETY REQUIREMENTS

1. References

- 1.1.** CSA S269.1-1975 Falsework for Construction Purposes.

2. CONSTRUCTION SAFETY MEASURES

- 2.1.** Observe construction safety measures of:

2.1.1. National Building Code 2010, Part 8

2.1.2. National Fire Code of Canada

2.1.3. Provincial Government, including but not limited to the:

2.1.3.1. Occupational Health & Safety Act revised Statutes of Nova Scotia 1996, Chapter 7 and regulations.

2.1.3.2. Workers' Compensation Act

2.1.3.3. Fire Protection Act

2.1.3.4. Dangerous Goods Transportation Act

- 2.2.** In case of conflict or discrepancy the more stringent requirement shall apply.

- 2.3.** Ensure that employees working on this specific project have met training requirements as legislated by the Nova Scotia Occupational Health & Safety Act and its regulations.

- 2.4.** Where reference is made to jurisdictional authorities, it shall mean all authorities who have within their constituted powers the right to enforce the laws of the place of the building.

3. Equipment & Tools

- 3.1.** Each user of equipment or tools shall be responsible to examine for sufficiency before use. Make equipment and tools safe if necessary.

4. WHMIS

- 4.1.** Comply with requirements of Workplace Hazardous Materials Information System (WHMIS) regarding use, handling, storage, and disposal of hazardous materials; and regarding labelling and provision of material safety data sheets.

- 4.2.** Have a copy of WHMIS data sheets available at the workplace on delivery of materials.

5. Hazardous Material

- 5.1. Should material resembling hazardous materials other than those identified with the Contract Documents, including but not limited to spray or trowel applied asbestos, be encountered in course of work; stop work immediately. Do not proceed until written instructions have been received from Consultant.
- 5.2. Where work entails use, storage, or disposal of toxic or hazardous materials, chemicals and or explosives, or otherwise creates a hazard to life, safety, health, or the environment; work shall be in accordance with the Jurisdictional Authority.

6. Site Cleaning

- 6.1. Except where special permission is obtained, maintain clear access on public sidewalks and roads.
- 6.2. Maintain walks and roads clear of construction materials and debris, including excavated material. Clean walks and roads as frequently as required to ensure that they are cleared of materials, debris and excavated material.

7. Fire Safety Requirements

- 7.1. Enforce fire protection methods, good housekeeping and adherence to local and Underwriter's fire regulations including, but not limited to, Fire Protection Act and the Provincial Building Code Act. Provide UL approved fire extinguishers, and other fire-fighting services and equipment, except where more explicit requirements are specified as the responsibility of individual Sections.
- 7.2. Smoking is not permitted on school property.
- 7.3. Advise Fire Chief in the area of Work of any work that would impede fire apparatus response, including but not limited to violation of minimum overhead clearance prescribed by the fire chief, erecting of barricades and digging of trenches and in areas where work is being done.
- 7.4. Ensure nothing subverts the integrity of fire protection provided for the building structure.

8. Reporting Fires

- 8.1. Know the location of the nearest fire alarm box and telephone, including the emergency phone number.
- 8.2. Report immediately all fire incidents to the fire department as follows:
 - 8.2.1. Activate nearest fire alarm box, or
 - 8.2.2. Telephone local fire department
 - 8.2.3. Where fire alarm box is exterior to building, the person activating the fire alarm box shall remain at the box to direct Fire Department to scene of the fire.

- 8.2.4. When reporting a fire by telephone, give location of fire, name or number of building and be prepared to verify the location.

9. Safety Document Submission

- 9.1. Ensure Safety Document Submission applies to Work of this specific project and site.
- 9.2. Submit two (2) copies of Project Safety Document at the Pre-Construction Meeting. Do not commence Work nor deliver material on-site prior to submission.
- 9.3. Include in Safety Document submission specific information detailing the methods and procedures to be implemented ensuring adherence to the acts, regulations, codes and policies specified in this section and to:
- 9.3.1. Ensure the Health & Safety of persons at or near the Work; including, but not limited to, the Public.
- 9.3.2. Ensure the measures and procedures of the regulatory agencies specified are carried out.
- 9.3.3. Ensure every employee, self-employed person and employer performing Work under this contract complies with the regulatory agencies specified.
- 9.3.4. Where changes to the methods and procedures in the execution of work change submitted safety methods and procedures, modify submitted Safety Documentation and submit modifications, in writing to the Consultant and Owner prior to implementation.

10. Safety Document Organization

- 10.1. Organize information in the form of an instructional manual as follows:
- 10.1.1. Place in binders of commercial quality, accommodating 8½" x 11" paper size.
- 10.1.2. Cover: Identify binder with typed or printed title 'Project Safety Document' and list the title of project.
- 10.1.3. Provide tabbed fly leaf for each separate heading, with typed heading on tab.
- 10.1.4. Where drawings are within the safety document, provide with reinforced punched binder tab. Bind in with text; fold in larger drawings to size of text pages.
- 10.1.5. Arrange content under Safety Document headings specified herein.

11. Safety Document Headings

11.1. Employee Safety Training

11.1.1. Place, under this heading, a statement indicating employees working on this specific project have met specified training requirements, if required.

11.2. Company Safety Policy

11.2.1. Place, under this heading, information pertaining to the company's policy and commitment to Occupational Health & Safety, including the responsibilities of management, supervisors and workers.

11.3. Company Safety Rules in General Terms

11.3.1. Place, under this heading, information of a general, global nature, applying to every work environment where the company has staff and pertaining to rules directing compliance to policy. For example state company safety rules with respect to use of hard hats, safety glasses, safety foot ware, CSA approval on such items, use of alcohol or non-prescription drugs.

11.4. Hazard Assessment

11.4.1. Place, under this heading, information identifying possible hazards specific to this project and identify safe methods and procedures for the execution of work to ensure safety in the work place.

11.4.2. Arrange contents of this heading by technical section number of the project manual.

11.5. Emergency Action Plan

11.5.1. Place, under this heading, information detailing action to be taken in the event of various emergencies.

11.5.2. Arrange content under the following sub-headings:

11.5.2.1. First Aid

11.5.2.1.1. Include information concerning establishment of a First Aid Station, related supplies, staff awareness of location and staff training in First Aid Care of Casualties.

11.5.2.2. Contact of Emergency Support Groups:

11.5.2.2.1. Include relative information including phone location for emergency use, the emergency telephone numbers and their location for the various organizations which must be contacted in case of an emergency, and staff training in procedures.

11.5.2.3. Cessation of Work:

11.5.2.3.1. Include relative information how work cessation during emergencies is handled and communicated to persons present on site.

11.6. Joint Occupational Health & Safety Committee/Representative:

11.6.1. Place under this heading information detailing membership and terms of reference.

OCCUPATIONAL HEALTH & SAFETY SUMMARY FOLLOWS THIS PAGE

Occupational Health & Safety Summary (to be submitted with each monthly Progress estimate)

The following information summarizes Occupational Health & Safety activities on the project conducted by the Contractor during the month and includes activities of Subcontractors. Activities include all matters prescribed by the Occupational Health & Safety Act and Regulations and the submitted Occupational Health & Safety Document for the Project.

Indicate the applicable # number below:

List new Contractors on Site below:

____ new contractors on site,

____ orientations

____ toolbox talks

____ safety meetings

____ Joint Occupational Health
and Safety Committee meetings

____ hazard assessments

____ formal written inspections

____ warnings issued to employees or subcontractors

____ other, explain _____

The Contractor certifies that the above noted activity list is accurate and that during the month:

Check

All activities on the Project were found to be in compliance with the Occupational Health & Safety Act and Regulations

Some activities on the Project were not found to be in compliance with the Occupational Health & Safety Act and Regulations but were adequately corrected in an appropriate time frame.
Explain _____

Prepared by

Certified by

(Contractor Project Manager)

(Contractor Senior Management)

END OF SECTION 01 35 29

SECTION 01 37 00 - SCHEDULE OF VALUES

1. Related Documents

1.1. General Conditions of Contract.

2. General

2.1. Submit to the Architect, and Owner, Schedule of Values, within twenty (20) days after signing Agreement.

2.2. Use Schedule of Values as basis for Contractor's Progress Claim.

3. Form Of Submittal

3.1. Form included at end of this Section.

4. Preparing Schedule Of Values

4.1. Itemize separate line item cost for work required.

4.2. Round off figures to nearest ten (10) dollars.

4.3. The sum of all values listed in the schedule shall equal the total contract sum.

5. Review And Submittal

5.1. After review by Architect and Owner, revise and resubmit Schedule as directed.

5.2. The form shall be completed and supported by such evidence as to its correctness as the Architect may reasonably direct.

Schedule Of Values

Project Name RECLADDING #3857 – TERENCE BAY ELEMENTARY

Contract Number _____

Architect _____

Contractor _____

Date _____

Item	Description	Item Amount
------	-------------	-------------

1. General Requirements

- 1.1. Mobilization & Initial Expenses
- 1.2. Site Overhead & Fee
- 1.3. Bonds
- 1.4. Certificates
- 1.5. Testing
- 1.6. Construction Facilities & Temporary Controls
- 1.7. Other (Specify)

Total (Items 1.1 to 1.7) _____

2. Excavation, Backfill, Sitework

Total (Item 2.) _____

3. Concrete

Total (Item 3.) _____

Item	Description	Item Amount
------	-------------	-------------

4. Masonry

Total (Item 4.) _____

5. Metals

Total (Item 5.) _____

6. Wood & Plastics

- 6.1. Rough Carpentry
- 6.2. Finish Carpentry
- 6.3. Architectural Woodwork

Total (Items 6.1 to 6.3) _____

7. Thermal & Moisture Protection

- 7.1. Insulation
- 7.2. Air Vapour Barrier
- 7.3. Aluminum Composite Panels
- 7.4. Preformed Metal Siding
- 7.5. Fire Stopping
- 7.6. Roofing

Total (Item 7.1 to 7.6) _____

8. Doors And Windows

- 8.1. Metal Doors & Frames
- 8.2. Wood Doors
- 8.3. Hardware
- 8.4. Windows

Total (Items 8.1 to 8.4) _____

<u>Item</u>	<u>Description</u>	<u>Item Amount</u>
-------------	--------------------	--------------------

9. Finishes

- 9.1. Acoustic Ceiling Systems
- 9.2. Gypsum Board and Support Systems
- 9.3. Hard Tile
- 9.4. Resilient Tile
- 9.5. Painting

Total (Items 9.1 to 9.5) _____

10. Specialties

- 10.1. Tackboards, Communication Boards
- 10.2. Toilet & Bath Accessories
- 10.3. Manufactured Specialties
- 10.4. Food Service Equipment

Total (Items 10.1 to 10.4) _____

11. Mechanical

- 11.1. As per Sections

Total (Item 11.) _____

12. Electrical

- 12.1. As per Sections

Total (Item 12.) _____

TOTAL (Items 1 - 12) _____

END OF SECTION 01 37 00

SECTION 01 41 00 - REGULATORY AGENCIES

1. Jurisdictional Authorities

- 1.1.** Where reference is made to jurisdictional authorities, it shall mean all authorities who have within their constituted powers the right to enforce the laws of the place of building.

2. Definitions

- 2.1.** The "Constructor" named in the Construction Safety Act, Chapter 52, Revised Statutes of Nova Scotia, as amended by 1972, Chapter 25; and Construction Safety Regulations, pursuant to Chapter 52 R.S.N.S., including any amendments, shall mean the "Contractor" for the Work performed under this Specification.

3. Fire Prevention, Safety & Protection

- 3.1.** General Construction Safety Measures:
- 3.1.1.** Observe safety measures of the
 - 3.1.1.1.** National Building Code 2010, Part 8.
 - 3.1.1.2.** National Fire Code of Canada.
 - 3.1.1.3.** Provincial Government, including but not limited to the Occupational Health & Safety Act Revised Statutes of Nova Scotia 1996, Chapter 320, and the Construction Safety & Industrial Safety Regulations made pursuant to the Occupational Health and Safety Act, 1996.
 - 3.1.1.4.** Workers'/Workmen's Compensation Board.
 - 3.1.2.** In case of conflict or discrepancy the more stringent requirement shall apply.
 - 3.1.3.** Maintain clear emergency exit paths for personnel.
- 3.2.** Except where special permission is obtained, maintain clear access on public sidewalks and roads.
- 3.3.** Maintain walks and roads clear of construction materials and debris, including excavated materials. Clean walks and roads as frequently as required to ensure that they are cleared of materials, debris and excavated materials.
- 3.4.** WHMIS:
- 3.4.1.** Comply with requirements of Workplace Hazardous Materials Information System (WHMIS) regarding use, handling, storage, and disposal of hazardous materials; and regarding labelling and provision of material safety data sheets acceptable to Labour Canada and Health & Welfare Canada.

- 3.4.2. Have a copy of WHMIS data sheets available at the workplace on delivery of materials.

Blockage Of Roadways

- 3.5. Advise Fire Chief of any work that would impede fire apparatus response. This includes violation of minimum overhead clearance, as prescribed by fire chief, erecting of barricades and the digging of trenches.

4. Smoking Precautions

- 4.1. Observe, at all times, smoking regulations.

5. Rubbish And Waste Materials

- 5.1. Rubbish and waste materials are to be kept to a minimum.
5.2. The burning of rubbish is prohibited.

6. Flammable And Combustible Liquids

- 6.1. The handling, storage and use of flammable and combustible liquids are to be governed by the current National Fire Code of Canada.
6.2. Flammable and combustible liquids such as gasoline, kerosene and naphtha will be kept for ready use in quantities not exceeding 45 litres provided they are stored in approved safety cans bearing the Underwriter's Laboratory of Canada or Factory Mutual seal of approval. Storage of quantities of flammable and combustible liquids exceeding 45 litres for work purposes, requires the permission of the Fire Chief.
6.3. Transfer of flammable and combustible liquids is prohibited within buildings or jetties.
6.4. Transfer of flammable and combustible liquids will not be carried out in the vicinity of open flames or any type of heat-producing devices.
6.5. Flammable liquids having a flash point below 38°C such as naphtha or gasoline will not be used as solvents or cleaning agents.
6.6. Flammable and combustible waste liquids, for disposal, will be stored in approved containers located in a safe ventilated area. Quantities are to be kept to a minimum and the Fire Department is to be notified when disposal is required.

7. Hazardous Substances

- 7.1. Work entailing the use of toxic or hazardous materials, chemicals and/or explosives, otherwise creates a hazard to life, safety or health, will be in accordance with the National Fire Code of Canada.

- 7.2. Where flammable liquids, such as lacquers or urethanes are to be used, proper ventilation will be assured and all sources of ignition are to be eliminated. The Fire Chief is to be informed prior to and at the cessation of such work.

8. Questions and/or Clarification

- 8.1. Direct any questions or clarification on Fire Safety in addition to above requirements to Fire Chief.

9. Fire Inspection

- 9.1. Site inspections by Fire Chief will be coordinated through AVRSB Project Manager.
9.2. Allow Fire Chief unrestricted access to the work site.
9.3. Co-operate with the Fire Chief during routine fire safety inspection of the Work site.
9.4. Immediately remedy all unsafe fire situations observed by the Fire Chief.

10. Reference Standards

- 10.1. Where edition date is not specified, consider that references to manufacturer's and, published codes, standards and specifications are made to the latest edition, (revision) approved by the issuing organization, current at the date of this Specification.
10.2. Reference standards and specifications are quoted in this Specification to establish minimum standards. Work which in quality exceeds these minimum standards shall be considered to conform.
10.3. Should the Contract Documents conflict with specified reference standards or specifications the General Conditions of the Contract shall govern.
10.4. Where reference is made to manufacturer's directions, instructions or specifications they shall include full information on storing, handling, preparing, mixing, installing, erecting, applying, or other matters concerning the materials pertinent to their use and their relationship to materials with which they are incorporated.
10.5. Have a copy of each code, standard and specification, and manufacturer's directions, instructions and specifications, to which reference is made in this Specification, always available at construction site.
10.6. Standards, specifications, associations, and regulatory bodies are generally referred to throughout the specifications by their abbreviated designations:

AA	The Aluminum Association
AISI	American Iron and Steel Institute
ANSI	American National Standards Institute
ARI	Air Conditioning & Refrigeration Institute
ASTM	American Society for Testing & Materials
CCA	Canadian Construction Association
CGSB	Canadian General Standards Board
CSA	Canadian Standards Association
NSDTIR	Department of Transportation & Infrastructure Renewal, Province of Nova Scotia
IAO	Insurers Advisory Organization
NBC	National Building Code
NFPA	National Fire Protection Association
CANS	Construction Association of Nova Scotia
ULC	Underwriters Laboratories of Canada
WHMIS	Workplace Hazardous Materials Information System

END OF SECTION 01 41 00

SECTION 01 45 00 - QUALITY CONTROL

1. Section Includes

- 1.1. Inspection and testing, administrative and enforcement requirements
- 1.2. Tests and mix designs.
- 1.3. Mock-ups.
- 1.4. Mill tests.
- 1.5. Equipment and system adjust and balance.
- 1.6. Verification by affidavits and certificates that specified products meet requirements of reference standards: In applicable Sections of the Specification.
- 1.7. Testing, balancing and adjusting of equipment: In applicable Mechanical and Electrical Sections of the Specification.
- 1.8. Cutting & Patching: Section 01 11 41.

2. Related Sections

- 2.1. Section 01 33 00 Submittal Procedures: Submission of samples to confirm product quality.
- 2.2. Section 01 61 00 Material & Equipment: Material and workmanship quality – reference standards.
- 2.3. Section 01 77 00 Contract Closeout.

3. REVIEW OF WORK

- 3.1. The Owner shall have access to the Work. If part of the Work is in preparation at locations other than the Place of the Work, access shall be given to such work whenever it is in progress.
- 3.2. Give timely notice to the Owner's Representative, requesting review of the Work as indicated in the Contract Documents.
- 3.3. If the Contractor covers or permits to be covered Work that has been designated for review by the Owner before such is made, uncover such Work, have the review satisfactorily completed and make good such Work at no extra cost to Owner.

4. Inspection, Special Tests, Approvals

- 4.1. Engage the services of appropriate inspection testing agencies ensuring the Work meets codes, acts and regulations, and laws in force at the place of Work. Include such costs in the Contract Price.

- 4.2. Give timely notice requesting inspection to those required to provide inspections, special tests, or approvals, where Work is designated, by the Owner's instructions or the law of the place of Work, for special tests.
- 4.3. If the Contractor covers or permits to be covered Work that has been designated for special tests, inspections or approvals before such is made, uncover such Work, have the inspections or tests satisfactorily completed and make good such Work at no extra cost to the Owner.
- 4.4. The Owner may order any part of the Work to be examined if the Work is suspected to be not in accordance with the Contract Documents. If, upon examination such Work is found not in accordance with the Contract Documents, correct such Work and pay the cost of examination and correction. If such Work is found in accordance with the Contractor Documents, the Owner shall pay the cost of examination and replacement.

5. Independent Inspection Agencies

- 5.1. Independent Inspection/Testing Agencies may be engaged by the Owner for the purpose of inspecting and/or testing portions of Work. Cost of such services will be borne by the Owner.
- 5.2. Provide access to the Work, and equipment required for executing inspection and testing by the appointed agencies.
- 5.3. Employment of inspection/testing agencies does not relax the Contractor's responsibility to perform Work, or carry out his own inspections and testing in accordance with the Contract Documents.
- 5.4. If defects are revealed during inspection and/or testing, the appointed agency will request additional inspection and/or testing to ascertain full degree of defect. Correct defect and irregularities as advised by Owner at no cost to the Owner. Pay costs for retesting and reinspection.

6. Access To Work

- 6.1. Allow inspection/testing agencies access to the Work, off site manufacturing and fabrication plants.
- 6.2. Co-operate to provide reasonable facilities for such access.

7. Procedures

- 7.1.** Notify the appropriate agency and Owner in advance of the requirement for tests, in order that attendance arrangements can be made.
- 7.2.** Submit samples and/or materials required for testing, at specifically requested in specifications. Submit with reasonable promptness and in an orderly sequence so as not to cause delay in the Work.
- 7.3.** Provide labour and facilities to obtain and handle samples and materials on site. Provide sufficient space to store and cure test samples.

8. Rejected Work

- 8.1.** Remove defective Work, whether the result of poor workmanship, use of defective products or damage and whether incorporated in the Work or not, which has been rejected, including (but not limited to) defective Work rejected by the Owner as failing to conform to the Contract Documents. Replace or re-execute in accordance with the Contract Documents.
- 8.2.** Make good other Contractor's work damaged by such removals or replacements promptly.
- 8.3.** If in the opinion of the Owner, it is not expedient to correct defective Work or Work not performed in accordance with the Contract Documents, the Owner may deduct from the Contract Price the difference in value between the Work performed and that called for by the Contract Documents, the amount of which shall be determined by the Owner.

9. Reports

- 9.1.** Submit four (4) copies of inspection and test reports to the Owner.
- 9.2.** Provide copies to Contractor's Consultant and Subcontractor of Work being inspected or tested.

10. Tests and Mix Designs

- 10.1.** Furnish test results and mix designs as may be requested.
- 10.2.** The cost of tests and mix designs beyond those called for in the Contract Documents or beyond those required by law of the Place of Work shall be appraised by the Owner and may be authorized as recoverable.

11. Mock-Up

- 11.1.** Prepare mock-up for Work for each finish in the Work and other work specifically requested in the specifications. Include for Work of all Sections required to provide mock-ups.
- 11.2.** Construct in all locations as specified in specific Section.
- 11.3.** Prepare mock-up for Owner's review with reasonable promptness and in an orderly sequence, so as not to cause any delay in the Work.
- 11.4.** Failure to prepare mock-up in ample time is not considered sufficient reason for an extension of Contract Time and no claim for extension by reason of such default will be allowed.
- 11.5.** If requested the Owner will assist in preparing a schedule fixing the dates for preparation.
- 11.6.** Mock-ups may remain as part of the Work, unless specified otherwise in the Contract Documents.

12. Mill Tests

- 12.1.** Submit mill test certificates as may be requested.

13. Equipment And Systems

- 13.1.** Submit adjustment and balancing reports for mechanical, electrical and building equipment systems.
- 13.2.** Refer to Contract Documents for definitive requirements.

END OF SECTION 01 45 00

SECTION 01 52 00 – CONSTRUCTION & TEMPORARY FACILITIES

1. General

- 1.1. Include in the Work construction and temporary facilities required as construction aids or by jurisdictional authorities or as otherwise specified. Install to meet needs of construction as Work progresses. Maintain construction and temporary facilities during use, relocate them as required by the Work, remove them at completion of need and make good adjacent Work and property affected by their installation.
- 1.2. Include in the Work construction and temporary facilities to provide for construction safety such as: fences, barricades, bracing, supports, storage, sanitation and first aid facilities, fire protection, stand pipes, electrical supply, construction equipment with its supports and guards, stairs, ramps, platforms, runways, ladders, scaffolds, guardrails, temporary flooring, rubbish chutes, and walkway, morality and guard lights, and as otherwise required of the Constructor by the Construction Safety Act, of the Province of Nova Scotia, as well as all other applicable regulations or jurisdictional authorities.
- 1.3. Construct temporary Work of new materials unless use of second-hand materials is approved.
- 1.4. Ensure that structural, mechanical, and electrical characteristics of temporary facilities are suitable and adequate for use intended. Be responsible that no harm is caused to persons and property by failure of temporary facilities because of placing, location, stability, protection, structural sufficiency, removal, or any other cause.
- 1.5. Locate temporary facilities as directed and coordinated with School Administration and HRSB.
- 1.6. Relocate construction and temporary facilities as required by the Progress of the Work, and remove at completion of Work.
- 1.7. Do not permit construction personnel to use new washroom and toilet facilities.
- 1.8. Interior work zones to be complete with temporary negative air ventilation units to be functioning at all times to control dust migration to occupied areas.
- 1.9. Refer also to HRSB Policies & Guidelines contained in Appendix A of Section 01 35 13.

2. Services

- 2.1. Temporary Electric Power:
 - 2.1.1. The Contractor will provide a source of electric power for all construction purposes.
 - 2.1.2. Coordinate with the Building Operator locations of power sources and arrange to connect under his direction.
 - 2.1.3. Install electric service distribution conductors and necessary components. Determine anticipated demand which will be placed on service during normal peak

periods and obtain approval on this basis before making installation. Supply power of characteristics required by the Work. Install a power centre for miscellaneous tools and equipment for each major building floor area with distribution box, a minimum of four 20 amp grounded outlets, and circuit breaker protection for each outlet. Make connections available to any part of the Work within distance of a 100'-0" extension.

2.2. Temporary Lighting:

2.2.1. Install lighting for

2.2.1.1. emergency evacuation, safety and security throughout the Project at intensity levels required by jurisdictional authorities.

2.2.1.2. performance of Work throughout Work areas as required, evenly distributed, and at intensities to ensure that proper installations and applications are achieved.

2.2.1.3. performance of finishing Work in areas as required, evenly distributed and of an intensity of at least 15 foot candles.

2.2.2. Permanent fluorescent lighting may be used during construction, provided that fixtures, lamps and lenses are completely cleaned. Incandescent sources may be used during construction to the extent of 20% of the total. Electrical Division Contractor to provide 20% spare lamps to the Owner for replacement purposes.

2.3. Temporary Sanitary Facilities:

2.3.1. Provide sanitary facilities for persons on the Work site. Facilities in areas of the building are only to be used under extraordinary circumstances and with prior approval.

2.4. Maintain fire protection as required by jurisdictional authorities. The Contractor is responsible for de-activating and re-activating Fire Alarm zones as required by the Work of the Contract and to maintain protection in the existing building.

3. Construction Aids

3.1. Hoists & Cranes:

3.1.1. Select, operate and maintain hoisting equipment and cranes as may be required. Operate such equipment only by qualified hoist or crane operators. Make hoist available for Work of each Section.

3.2. Building Enclosure:

3.2.1. Include in Work temporary enclosure for building as required to protect it, in its entirety or in its parts, against the elements, to maintain environmental conditions

required for Work. Design enclosures to withstand wind pressures required for the building by jurisdictional authorities. Erect enclosures to allow complete accessibility for installation of materials during the time enclosures remain in place.

3.3. Scaffolding:

- 3.3.1. Each user of scaffolding shall be responsible for its examination and testing for sufficiency before using it. He shall make it secure if necessary, or shall notify the Contractor in writing that he will not commence work until it is made secure; otherwise he will be held responsible for accidents due to its insufficiency.

4. Barriers

- 4.1. Install barricades for traffic control, and to prevent damaging traffic over exterior and interior finished areas, as well as safety barricades and otherwise, as may be required.
- 4.2. Construct hoardings and walkways as required by HRSB or jurisdictional authorities.

5. Protection

- 5.1. Protect roofs and podiums by substantial temporary construction to ensure that no damage occurs. Provide protection by materials of sufficient thickness to prevent all damage to structure and finish, and to waterproofing qualities of membranes, whenever each of these individual components are exposed. Damage shall include harm resulting from all construction work, such as falling objects, wheel and foot traffic, failure to remove debris, operation of machinery and equipment, and scaffolding and hoisting operations. Positively secure protection to prevent displacement from any cause.
- 5.2. Box with wood or otherwise protect from damage, by continuing construction, finished sills, jambs, corners, and the like.

END OF SECTION 01 52 00

SECTION 01 61 00 - MATERIAL & EQUIPMENT

1. General

- 1.1.** Products refer to materials, manufactured components and assemblies, fixtures and equipment incorporated in the Work.
- 1.2.** Use only products of Canadian manufacture unless such products are not manufactured in Canada, are specified otherwise, or are not competitive.
- 1.3.** Products for use in the Project and on which the Tender was based shall be in production at that time, with a precise model and shop drawings available for viewing.
- 1.4.** Where equivalent products are specified, or where alternatives are proposed under "substitution of products", these products claimed by the Contractor as equivalent shall be comparable in construction, type, function, quality, performance, and, where applicable, in appearance, as approved. Where specified equivalents are used in the tendered bulk sum price for the Work, they shall be subject to final approval.
- 1.5.** Incorporate products in the Work in strict accordance with manufacturers' directions unless specified otherwise.
- 1.6.** Products delivered to the Project site for incorporation in the Work shall be considered the property of the Owner. Maintain protection and security of products stored on the site after payment has been made for them.
- 1.7.** Do not install permanently incorporated labels, trademarks and nameplates, in visible locations unless required for operating instructions or by jurisdictional authorities.

2. Specified Products

- 2.1.** Products specified by manufacturer's name, brand name or catalogue reference shall be the basis of the bid and shall be supplied for the Work without exception in any detail, subject to allowable substitutions as specified.
- 2.2.** Where several proprietary products are specified, any one of the several will be acceptable.
- 2.3.** For products specified by reference standards, the onus shall be on the supplier to establish that such products meet reference standard requirements. The Architect may require affidavits from the supplier, as specified in Section 01 33 00, or inspection and testing at the expense of the supplier, or both, to prove compliance. Products exceeding minimum requirements established by reference standards will be accepted for the Work if such products are compatible with and harmless to Work with which they are incorporated.

3. Substitution Of Products During Progress Of Work

- 3.1.** Products substituted for those specified or approved, or both, shall be permitted only if the listed product cannot be delivered to maintain construction schedule and if the delay is caused by conditions beyond the Contractor's control.
- 3.2.** Obtain approval for substitutions. Application for approval of substitutions shall be made only by Contractor. Process proposals for substituted Work in accordance with procedures established for changes in the Work.
- 3.3.** Submit, with request for substitution, documentary evidence that substituted products are equal to, or superior to, approved products, and a comparison of price and delivery factors for both specified or approved products, and proposed substitute.
- 3.4.** Ensure that substituted products can be both physically and dimensionally incorporated in the Work with no loss of intended function, performance, space or construction time, and that spare parts and service are readily available. The Contractor shall be responsible for additional installation costs, including architectural and engineering fees, required by incorporation of substituted products, and for adaptations made otherwise necessary to ensure that above requirements are satisfied.

4. Product Handling

- 4.1.** Manufacture, pack, ship, deliver and store products so that no damage occurs to structural qualities and finish appearance, nor in any other way detrimental to their function or appearance, or both.
- 4.2.** Ensure that products, while transported, stored or installed, are not exposed to an environment which would increase their moisture content beyond the maximum specified.
- 4.3.** Schedule early delivery of products to enable Work to be executed without delay. Before delivery, arrange for receiving at site.
- 4.4.** Deliver package products, and store until use, in original unopened wrapping or containers, with manufacturer's seals and labels intact.
- 4.5.** Label packaged products to describe contents, quantity and other information as specified.
- 4.6.** Product handling requirements may be repeated and additional requirements specified, in other Sections.

5. Storage & Protection

- 5.1. Coordinate material delivery to ensure that areas within or on building are available to receive them.
- 5.2. Store manufactured products in accordance with manufacturer's instructions, when such instructions are attached to products or submitted by him.
- 5.3. Store finished products and woodwork under cover at all times.
- 5.4. Store and handle flammable liquids and other hazardous materials in approved safety containers and as otherwise prescribed by safety authorities. Store no flammable liquids or other hazardous materials in bulk within the Project.
- 5.5. Storage and special protection requirements may be repeated, and additional requirements specified, in other Sections.

6. Defective Products & Work

- 6.1. Products and Work found defective; not in accordance with the Specifications; or defaced or injured through negligence of the Contractor, his employees or subcontractors, or by fire, weather or any other cause will be rejected for incorporation in the Work.
- 6.2. Remove rejected products and Work from the premises immediately.
- 6.3. Replace rejected products and Work with no delay after rejection. Provide replacement products and execute replacement Work precisely as required by the Specification for the defective Work replaced. Previous inspection and payment shall not relieve the Contractor from the obligation of providing sound and satisfactory Work in compliance with this Project Manual.

7. Workers, Suppliers & Subcontractors

- 7.1. Assign Work only to workers, suppliers, and Subcontractors who have complete knowledge, not only of the conditions of this Project Manual, but of jurisdictional requirements, and reference standards and specifications.
- 7.2. Give preference to use of local workers, suppliers, and Subcontractors wherever possible.

8. Workmanship

- 8.1. Unless otherwise specified in a more detailed manner, workmanship shall be of the highest quality recognized by trade executing the Work in accordance with standard practices, by the best methods recommended by the manufacturer of the Product, and as approved by the Architect.

END OF SECTION 01 61 00

SECTION 01 77 00 – CONTRACT CLOSEOUT

1. Section Includes

- 1.1. Final cleaning.
- 1.2. Spare parts and maintenance materials.
- 1.3. Take over procedures.

2. Related Sections

- 2.1. Individual Specifications Sections: Specific requirements for operation and maintenance data.

3. Final Cleaning

- 3.1. Refer to the General Conditions of Contract.
- 3.2. Before final inspection, replace glass and mirrors broken, damaged and etched during construction, or which are otherwise defective.
- 3.3. In addition to requirements for cleaning-up specified in General Conditions of the Contract, include in Work final cleaning by skilled cleaning specialists on completion of construction.
- 3.4. Remove temporary protections and make good defects before commencement of final cleaning.
- 3.5. Remove waste products and debris other than that caused by the Owner, other contractors or their employees, and leave the Work clean and suitable for occupancy by Owner.
- 3.6. Remove surplus products, tools, construction machinery and equipment. Remove waste products and debris other than that caused by the Owner or other Contractors.
- 3.7. Clean and polish glass, mirrors, hardware, wall tile, stainless steel, chrome, porcelain enamel, baked enamel, plastic laminate, mechanical and electrical fixtures. Replace broken, scratched or disfigured glass.
- 3.8. Remove stains, spots, marks and dirt from decorative work, electrical and mechanical fixtures, furniture fitments, walls, and floors and ceilings.
- 3.9. Vacuum clean and dust building interiors, behind grilles, louvres and screens as affected by Work.
- 3.10. Wax, seal, shampoo, buff or prepare floor finishes, as recommended by the manufacturer. Use products compatible with products used by building maintenance staff.
- 3.11. Broom clean and wash all horizontal and vertical surfaces as affected by Work.
- 3.12. Clean up and make good exterior grades, lawns, planting and surfaces after removal of temporary access and facilities.
- 3.13. Removing of visible labels left on materials, components, and equipment.

3.14. Maintain cleaning until Owner has taken possession of building or portions thereof.

4. Spare Parts And Maintenance Materials

- 4.1. Spare parts and maintenance materials provided shall be new, not damaged or defective, and of the same quality and manufacture as Products provided in the Work. If requested, furnish evidence as to type, source and quality of Products provided.
- 4.2. Defective Products will be rejected, regardless of previous inspections. Replace products at own expense.
- 4.3. Store spare parts and maintenance materials in a manner to prevent damage, or deterioration.
- 4.4. Provide spare parts, special tools, maintenance and extra materials in quantities specified in individual specification Sections.
- 4.5. Provide items of same manufacture and quality as items in the Work.

5. Demonstration Of Systems & Equipment

- 5.1. Give a complete demonstration of all systems and equipment in the presence of the Consultant at the following times:
 - 5.2. When each is 100% completed at the request of the Contractor.
 - 5.3. At time of inspection to validate final completion.
 - 5.4. At final completion for the benefit of the maintenance staff for the Project.
 - 5.5. Responsible personnel representing the Subcontractor responsible for the Work being demonstrated shall be present at each demonstration.

6. Submittals

- 6.1. Submit with application for substantial performance certificate.
 - 6.1.1. Certificate of substantial completion inspection report from electrical utility or inspection.
 - 6.1.2. Certificate of verification of fire alarm system.
 - 6.1.3. Certificate from the Fire Marshal's Office and I.A.O. of final inspection of sprinkler system.
 - 6.1.4. Air balance reports.
 - 6.1.5. Other reports required or specified.
 - 6.1.6. Maintenance Manuals and Operating Instructions.
- 6.2. Submit with application for release of final payment:
 - 6.2.1. Final project record drawings.
 - 6.2.2. Extra stock.

- 6.2.3. Performance bonds which shall remain in effect for one (1) year after take-over date.
- 6.2.4. Completed Liability Insurance Policy extended for one (1) year from take-over date.
- 6.2.5. Written guarantee covering all workmanship and materials used in the Work.
- 6.2.6. Maintenance bonds as specified.
- 6.2.7. Extended Warranties as specified
- 6.2.8. Certificate from Workers' Compensation Board.
- 6.2.9. Certificate from Health Services Tax Division.

7. Final Inspection Procedures

- 7.1. Schedule, make arrangements for and administer final inspections and close out in the following stages.
- 7.2. Contractor's Inspection:
 - 7.2.1. Determination that Project meets requirements for substantial performance and inspection is the responsibility of the Contractor.
 - 7.2.2. The Contractor and all Subcontractors shall conduct an inspection of the work, identify deficiencies and defects; repair as required. Notify the Consultant in writing of satisfactory completion of the contractor's Inspection and that corrections have been made. Request a Consultant's Substantial Performance Inspection.
- 7.3. Consultant's Inspection: Consultants and the Contractor will perform an inspection of the Work to identify obvious defects or deficiencies. The contractor shall correct Work accordingly.
- 7.4. Substantial Performance Inspection:
 - 7.4.1. When the items noted above are complete, request a substantial performance inspection of the Work by the Consultant, and the Contractor. If Work is deemed incomplete by the Consultant, complete the outstanding items and request a re-inspection.
 - 7.4.2. Substantial performance inspections shall be scheduled to begin within eight working days of the Contractor's request.
 - 7.4.3. Present at the substantial performance inspection will be:
 - 7.4.3.1. The Consultant and his Sub-consultants that he requires and notifies.
 - 7.4.3.2. The Owner's representatives, upon notification by the Consultant.
 - 7.4.3.3. The Contractor and such Subcontractors that he considers are required.
 - 7.4.3.4. The Contractor will compile a substantial performance deficiency list at this inspection and issue it to the Consultant and Owner.
 - 7.4.3.5. The Contractor shall correct substantial performance deficiencies before a date agreed upon by the Contractor and Consultant.

- 7.4.3.6. Upon the Consultant's approval of substantial performance, the Contractor shall submit an application for a substantial performance certificate.
- 7.4.3.7. When the Contractor has satisfied himself that these corrections have been completed in a satisfactory manner by his inspection he shall schedule a final Contractor's inspection by the Consultant, and the Owner's representatives if required, within five working days of the Contractor's request.
- 7.4.3.8. Upon the Consultant's approval of completion, the Contractor shall submit an application for a completion certificate.

8. Substantial Performance

- 8.1. The Consultant will issue a Certificate of Substantial Performance when satisfied outstanding deficiencies noted during inspections prior to the substantial completion inspection have been corrected, the Work is substantially complete and is so certified by the Owner.
- 8.2. A list of remaining deficiencies to be rectified before final acceptance will be attached to the Certificate of Substantial Performance.
- 8.3. Make submissions specified in Subparagraph 1.06 of this Section.

9. Certificate For Release Of Amount Due At Substantial performance

- 9.1. The Consultant will issue to the Owner a certificate for release of money in an amount equal to the amount due the Contractor under the Agreement providing he is satisfied the Work has been substantially completed.
- 9.2. The certificate shall indicate the date of substantial performance.
- 9.3. Payment shall be due upon date of substantial performance.

10. Completion Certificate

- 10.1. The Consultant will issue a Certificate of Completion (DSS Document DC670-92) when he is satisfied that outstanding deficiencies noted during inspections have been corrected and the Work is completed and is so certified by the Owner.
- 10.2. The date of the completion certificate will commence the required sixty (60) day period before release of final payment.

11. Certificate For Release Of Final Payment

- 11.1. The Consultant will issue to the Owner a certificate for release of final payment sixty (60) days after date of completion certificate providing he is satisfied the Work has been completed.

- 11.2. The certificate will be in an amount equal to the remaining money due the Contractor under the Contract, and shall indicate the date of final completion.
- 11.3. Payment shall be due upon date of final completion.

12. Warranties

- 12.1. Establishment of Warranties:
 - 12.1.1. Warranties shall commence on date of substantial performance certificate.
- 12.2. Warranty Period:
 - 12.2.1. The Owner will advise the Consultant of defects observed during warranty periods.
 - 12.2.2. The Consultant will notify the Contractor of defects observed during warranty period and request him to remedy the defects in accordance with the Contractor documents.
 - 12.2.3. Thirty (30) days before expiration of warranties the Owner's representatives, the Consultant and the Contractor will inspect the Work as arranged by the Contractor noting defects of products and workmanship.
 - 12.2.4. The Contractor shall immediately remedy such noted defects.

END OF SECTION 01 77 00

CONTRACTOR'S CHECKLIST

Enclose the following documents with your bid:

- Bid Security as required in section 21.1(Information for Bidders)*** - in the amount of 10% of the Contract Price (before HST).
- Contract Security for bids over \$100,000 as required in section 22.6.1.1(Information for Bidders)*** – required upon award)
- Certificate of Insurance*** indicating a minimum of ***\$5,000,000 Commercial General Liability Insurance*** per occurrence and ***Commercial Auto Liability Insurance*** covering all owned, non-owned and hired vehicles for a minimum combined single limit of ***\$2,000,000*** per occurrence and ***Builder's Risk Insurance*** in the amount of the contract price.
- Tentative Work Schedule (Timelines)*** – Subsequently, within five (5) business days of tender award the successful bidder shall provide a schedule clearly indicating timelines for completion of all aspects of the project.
- Workers' Compensation Board Letter*** of Good Standing
- Certificate of Recognition from one of the seven safety audit companies that jointly sign with the WCB:***
 - East Coast Mobile Medical Inc.
 - HSE Integrated
 - Nova Scotia Construction Safety Association
 - Nova Scotia Trucking Safety Association
 - Occupational Health & Educational Services (2002) Inc.
 - Safety Services Nova Scotia
 - Stantec Inc.This list can be found on WCB's website: www.wcb.ns.ca.
- Completed HRSB Safety Plan***
- Applicable Warranty Information***



Project Safety Plan Outline

During the planning of each project, environmental and occupational health and safety issues will be assessed like any other key project component.

Prior to beginning a new project, tendering contractors shall examine the work area to identify potentially hazardous site specific situations.

Once identified, these hazards should be prioritized on this Hazard Assessments/Project Safety Plan Outline and corrective *actions* noted to eliminate or control each hazard. The dates of when and names of the persons who are responsible for completing the *action* should also be assigned.

Copies of the completed Safety Plan Outline shall be submitted as part of the tender document submittal, sent to the HRSB Operations Services Regional Manager, made available on the job site and communicated to the workers.

Project Name: _____

Project Location: _____

Project Start date: _____

Project End date: _____

Company Name: _____

Completed by: _____

(Contractor's project manager)

Date: _____

Copy to: _____

PLANNING:

Does the Contractor's Occupational Health and Safety Program deal with the work activities associated with this project? Yes No

Describe tasks to be undertaken: _____

HAZARDS ASSESSMENT:

Identify the hazards that could present themselves on this project (e.g. live electrical wires, over water, confined space, etc) and describe what steps will be taken to prevent an incident (e.g. cover up, de-energize, safe work practices, netting, etc). Prioritize from #1 as needing immediate action.

#	Hazard	Required Action	Completed by	Date
1				
2				
3				
4				
5				
6				
7				
8				
9				
10				

ENVIRONMENTAL ASSESSMENT:

Identify the environmental issues that could present themselves on this project (e.g. oil spills, asbestos, etc.) and describe the action that will be taken to eliminate or reduce the risk of occurrence (e.g. mop kits, air sampling, etc.)

#	Hazard	Required Action	Completed by	Date
1				
2				
3				
4				
5				

EMERGENCY RESPONSE:

In the event of an incident, pre-plan the response and write up the procedures. Minimally, the following list should be completed and posted on site:

Contact	Phone #	Contact	Phone #
Fire	911	Poison Control	428-8161
Ambulance	911	Dangerous Goods	1-800-565-1633
Doctor	911	Waste Disposal	
Police	911	Insurance	
HRSB Office	493-5110	Min/Dept of Labour	1-800-952-2687
Min./Dept.of Transport.		Min/Dept of Environment	1-800-565-1633

- Identify and arrange source of first aid, ambulance and rescue.
- Accidents will be reported to: _____
- Accidents will be investigated by: _____
- Back-up call to: _____
- HRSB # emergency/after hours: day 493-5110 after 4:00 pm 442-2476

SAFETY MEETINGS:

On this project, given the nature of the work and the anticipated size of the work force, the following frequency will apply:

Site meetings _____

Site Audits _____

Follow up with HRSB Manager: _____

SITE IMPLEMENTATION:

- Health and Safety Rep & Safety Committee:
Establish liaison between HRSB, contractor, site administration
First Aid, PPE, other safety items as required.

- Documentation:
Applicable MSDS
Safety program
Applicable work procedures
Permits
First Aid Certification

TRAINING:

The following training/testing will be mandatory on site:

1) _____

2) _____

3) _____

TENTATIVE SCHEDULE OF WORK:

- 1) Date Project Will Commence: _____
- 2) Number of Weeks to Complete Project: _____ weeks

NOTE:

Within one week of tender award the successful bidder shall provide a schedule clearly indicating timelines for completion of all aspects of the project.

**ASBESTOS SURVEY,
Terence Bay School**
1714 Lower Prospect Road
Terence Bay, NS
B3T 1Y6

Prepared by:

Maritime Testing (1985) Limited
116-900 Windmill Rd
Dartmouth, N.S.

Prepared for:

Halifax Regional School Board
90 Alderney Dr., 3rd floor
Dartmouth, N.S.
B2Y 4S8

March 19, 1999

NEO-1256.112

INTRODUCTION

The Halifax Regional School Board has undertaken a mandate to conduct asbestos inventories in each of the schools in the School Board region. Maritime Testing (1985) Limited (MTL) was retained by the Board to conduct these inventories and prepare the asbestos survey reports. This report on Terence Bay School represents one of the schools surveyed as part of this comprehensive inventory.

METHODS

Each school was inspected for building materials that might be composed of asbestos containing minerals (ACMs). Types of materials examined and sampled as needed could include but not necessarily be limited to:

mechanical systems:	insulation on pipes, fittings, boilers, air conveyance systems, structural materials
flooring:	sheet flooring, vinyl tiles
ceilings:	suspended ceilings, rigid ceilings, texture coats
walls:	texture coats, wallboards, plasters
building exterior:	wall panels, panels under entrances

Please note the following limitations regarding these surveys:

1. Sampling and inspection was not conducted if permanent visible damage would result from these activities. In such circumstances, inference is made to the potential for ACMs to be present based upon other observations made in the building (for example, holes are not cut into wall cavities to determine if insulated pipe work is present).
2. In each school, every room that was accessible was surveyed. In cases where access to a room was not possible, inference on that room is made based on what was observed throughout the rest of the school.
3. Plaster, unlike many other materials in schools such as floor tiles, ceiling tiles, etc., was originally fabricated on site. Each batch, which typically would be wheel barrow sized, could potentially be a bit different from the next. Asbestos, typically chrysotile, was used as well as other materials (hairs, wood) as a strengthening material and was applied "in shovelfuls" more or less at the discretion of the worker. Samples collected routinely in schools are based upon

perceived differences in texture, age of construction, etc., and may not reflect small differences from one batch to another, particularly since sample sizes are kept small to reduce damage. Accordingly, samples of plaster identified as not containing asbestos may well not be precisely indicative of the overall composition of the plaster in general. As a result, plaster should be assumed to contain asbestos unless a specific sample from the area in question has been analysed and shown to be asbestos free.

All inspections were scheduled such that sampling could be conducted after normal school hours. This school was surveyed on March 3, 1999.

Samples collected at the school were examined under both stereo and polarised light microscopy to determine fibre types and relative percentages of each asbestos mineral if it was present. As well, any ACMs were further categorised into one of three categories as noted below:

- Priority 1: materials representing a potential health risk with normal routine building use and which require immediate removal. Such materials may include damaged ceiling tiles, damaged pipe insulation, damaged friable boiler insulation.
- Priority 2: materials which do not pose a health risk under normal school usage but which pose a periodic risk to maintenance and custodial staff or which are currently undamaged but which might easily be damaged in the future; these materials require removal during the next suitable time (ie a major school break, next planned renovation project). Such materials may include undamaged ceiling tiles, damaged pipe insulation above ceilings, undamaged texture coats.
- Priority 3: Non-friable materials or materials that are in good condition, are not generally accessible, and which currently pose no risk to any occupant. Such materials may include floor tiles, transite panels, mechanical insulation in good repair.

Refer to Appendix A for a summary of the Priorities of the ACMs.

Data are also available on an asbestos inventory data base, accessible from the school board offices prepared specifically by MTL for this project.

For a list of materials sampled, refer to Appendix B. Refer to Appendix C for a diagram of the school floor plan and sample locations. For a list of locations and quantities of

asbestos containing materials, refer to Appendix D. Refer to Appendix E for a room by room account of ACM's. Refer to Appendix F for photos of Priority 1 ACMs.

INVENTORY RESULTS.

This building was constructed in the 1960's.

Boiler Room: None of the materials in the boiler room contain asbestos.

Exterior: None of the materials on the exterior contain asbestos.

Floors: A variety of 9" and 12" floor tiles contain 10% chrysotile asbestos. The tile is in good condition and a Priority 3. None of the other floor coverings contain asbestos.

Walls: The plaster walls in some areas of the school contain 2-3% chrysotile asbestos. The plaster is in good condition and a Priority 3. None of the other wall materials contain asbestos.

Ceilings: None of the ceiling materials in this school contain asbestos.

Pipe Systems: None of the pipe insulation material contains asbestos.

Appendix A:

Summary: The following is a summary of Priorities of the various ACMs at this school:

Priority 1: • none

Priority 2: • none

Priority 3: • throughout the school, asbestos floor tile
• throughout the school, plaster walls

Appendix B:

<u>Samples taken and locations</u>			
<u>#</u>	<u>Sample description</u>	<u>Location</u>	<u>ACM</u>
<u>Boiler Room</u>			
112.1	insulation on pipe elbow	boiler room	no
112.2	boiler exhaust	boiler room	no
<u>Exterior</u>			
No samples taken			
<u>Floors</u>			
112.3	9" tile, grey with black streaks	grade 4/5	yes
112.4	9" tile, slate with white and dark green streaks	grade 4/5	yes
112.5	9" tile, black with white streaks	grade 4/5	yes
112.6	9" tile, beige with yellow and brown streaks	french room	yes
112.7	9" tile, brown with light and dark brown streaks	french room	yes
112.8	12" tile, beige with brown and white streaks	resource room	no
112.9	12" tile, red with white streaks	resource room	no
112.10	9" tile, green with green and white streaks	kitchen	yes
112.11	9" tile, grey with black streaks	kitchen	yes
112.12	12" tile, pink flecks	canteen	no
112.13	12" tile, grey with white and grey streaks	canteen	yes
112.15	12" tile, grey with white, black and brown swirls	grade 1 /2	no
112.17	12" tile, brown marble	library	no
<u>Walls</u>			
112.16	plaster	grade 1 /2	yes
<u>Ceilings</u>			
112.14	2'x2' suspended tile	canteen	no

Appendix B:

<u>Samples taken and locations</u>			
<u>#</u>	<u>Sample description</u>	<u>Location</u>	<u>ACM</u>
	<u>Pipes</u>		
	No samples taken		
	<u>Miscellaneous</u>		
	No samples taken		

Appendix D:

Quantity and locations of ACMs.

Boiler Room

No ACM's

Exterior

No ACM's

Floors

<u>Description</u>	<u>Locations</u>	<u>Quantity (ft.²)</u>
9" tile, beige with yellow and brown streaks	kitchen washroom	10
9" tile, beige with yellow and brown streaks	hallway	408
9" tile, beige with yellow and brown streaks	gymnasium and stage	610
9" tile, beige with yellow and brown streaks	office	52
9" tile, beige with yellow and brown streaks	french room	268
9" tile, black with white streaks	music room	104
9" tile, black with white streaks	french room	104
9" tile, black with white streaks	kitchen	64
9" tile, black with white streaks	hallway	201
9" tile, black with white streaks	gymnasium and stage	156
9" tile, black with white streaks	grade 4/5	104
9" tile, black with white streaks	kitchen washroom	30
9" tile, black with white streaks	office	50
9" tile, brown with light and dark brown streaks	french room	268
9" tile, brown with light and dark	office	52

Floors

<u>Description</u>	<u>Locations</u>	<u>Quantity (ft.²)</u>
brown streaks		
9" tile, brown with light and dark brown streaks	gymnasium and stage	610
9" tile, brown with light and dark brown streaks	hallway	408
9" tile, brown with light and dark brown streaks	kitchen washroom	10
9" tile, green with green and white streaks	kitchen	92
9" tile, grey with black streaks	music room	286
9" tile, grey with black streaks	grade 4/5	286
9" tile, grey with black streaks	kitchen	92
12" tile, grey with white and grey streaks	grade primary	782
12" tile, grey with white and grey streaks	canteen	70
9" tile, slate with white and dark green streaks	grade 4/5	286
9" tile, slate with white and dark green streaks	music room	286

Walls

<u>Description</u>	<u>Locations</u>	<u>Quantity(ft²)</u>
plaster	grade 1 /2	1000
plaster	pre-school room	1000
plaster	library	1000
plaster	grade primary	1000
plaster	store	200
plaster	hallway	900

Ceilings
No ACM's

Pipes
No ACM's

Miscellaneous
No ACM's

Appendix E:

ACM's Room by Room (for quantities refer to Appendix D).

<u>Room</u>	<u>ACMs</u>
canteen	12" floor tile, grey with white and grey streaks
french room	9" floor tile, brown with light and dark brown streaks, 9" floor tile, black with white streaks, 9" floor tile, beige with yellow and brown streaks
grade primary	plaster wall
grade primary	12" floor tile, grey with white and grey streaks
gymnasium and stage	9" floor tile, brown with light and dark brown streaks, 9" floor tile, black with white streaks, 9" floor tile, beige with yellow and brown streaks
hallway	plaster wall, 9" floor tile, brown with light and dark brown streaks, 9" floor tile, black with white streaks, 9" floor tile, beige with yellow and brown streaks
kitchen	9" floor tile, grey with black streaks, 9" floor tile, black with white streaks, 9" floor tile, green with green and white streaks
kitchen washroom	9" floor tile, brown with light and dark brown streaks, 9" floor tile, black with white streaks, 9" floor tile, beige with yellow and brown streaks
library	plaster wall
music room	9" floor tile, slate with white and dark green streaks, 9" floor tile, black with white streaks, 9" floor tile, grey with black streaks
office	9" floor tile, brown with light and dark brown streaks, 9" floor tile, black with white streaks, 9" floor tile, beige with yellow and brown streaks
pre-school room	plaster wall
store	plaster wall
grade 1 /2	plaster wall
grade 4/5	9" floor tile, slate with white and dark green streaks, 9" floor tile, black with white streaks, 9" floor tile, grey with black streaks

Appendix F: There are no Priority 1's in this school.

LIST of DRAWINGS

A-0 GENERAL NOTES
A-1 FLOOR PLANS
A-2 BUILDING ELEVATIONS - EXISTING CONDITIONS
A-3 BUILDING ELEVATIONS - NEW CONDITIONS
A-4 CLADDING DETAILS
A-5 CLADDING DETAILS

TERENCE BAY RE-CLADDING

TERENCE BAY, N.S.

ISSUED FOR TENDER

PROJECT NAME:

FBM PROJECT NO.: 2015-117

CONTRACT NO.:

DATE: 19 AUG 2016

SET NO.:



**FOWLER
BAULD &
MITCHELL**

architecture

Fowler Bauld & Mitchell Ltd.

HSI-1660 Hollis Street, Halifax, Nova Scotia B3J 1V7

PO Box 514, Halifax, Nova Scotia B3J 2R7

Tel: 902 429 4100 Fax: 902 423 3063

email: architects@fbm.ca www.fbm.ca

GENERAL NOTES:

- CONTRACTOR TO MAKE GOOD ALL EXISTING SURFACES AND FINISHES AFFECTED BY THE DEMOLITION AND RENOVATION AS DETAILED AND /OR IMPLIED BY THE DRAWINGS. WHERE NECESSARY TO REPAIR TO MATCH ADJACENT MATERIALS AND FINISHES, EXTEND PATCH TO NEAREST NATURAL BREAK POINT I.E. INSIDE CORNER, EXIST. JOINT OR LOCATION APPROVED BY THE ARCHITECT.
- CONTRACTOR TO PROTECT AND MAINTAIN THE INTEGRITY OF EXISTING FINISHES IN ALL AREAS NOT SCHEDULED FOR DEMOLITION WORK. ANY DAMAGE DUE TO DEMOLITION AND/OR NEW CONSTRUCTION TO BE REPAIRED AND MADE GOOD.
- DO NOT ALLOW ANY ADHESIVE ODOURS AND OTHER FUMES FROM CONSTRUCTION ACTIVITIES TO ENTER MECHANICAL SYSTEMS.
- CONTRACTOR TO REMOVE AND LAWFULLY DISPOSE OFF SITE ALL RUBBISH AND DEBRIS RESULTING FROM CONSTRUCTION. KEEP PROJECT AREA BROOMCLEAN. WHENEVER APPLICABLE, ALL DEMOLITION DEBRIS TO BE SORTED AND TAKEN TO APPROPRIATE FACILITIES FOR RECYCLING.
- CONTRACTOR TO SEAL AND REPAIR CUT-OUTS FOR MECHANICAL AND ELECTRICAL PENETRATIONS IN WALLS. PROVIDE FINISHES TO MATCH EXISTING UNLESS OTHERWISE SPECIFIED.
- CONTRACTOR IS RESPONSIBLE FOR THE DESIGN, COORDINATION AND EXECUTION OF CONSTRUCTION METHODS, PROCEDURES AND SCHEDULES. THE OPERATIONAL PROCEDURES AND METHODS ARE THE RESPONSIBILITY OF THE CONTRACTOR INSOFAR AS THEY DO NOT PRESENT HAZARDS TO PERSONNEL OR PROPERTY OR INFRINGE ON WORK SCHEDULES FOR NORMAL SITE ACTIVITY.
- REPORT ANY HAZARDOUS MATERIALS FOUND ON SITE TO HRSB PROJECT MANAGER.

PREPARATION & PROCEDURE

- EXTERIOR WALL
 - REMOVE ALL PARGING AND FIBRE MESH REINFORCING. SOME UNBONDED/LOOSE PARGING CAN BE REMOVED BY HAND. THE REMAINING PARGING STILL BONDED OR SEMI-BONDED, SHOULD BE REMOVED BY ELECTRIC CHIPPING HAMMERS.
 - REMOVE ALL LOOSE, CRACKED OR DAMAGED CONCRETE BY THE SAME METHOD AS DESCRIBED ABOVE FOR PARGING REMOVAL.
 - DEPRESSIONS OR GENERAL UNEVENNESS OF THE CONCRETE SURFACE DO NOT NEED TO BE FILLED/REPAIRED, AS THE CLADDING ASSEMBLY CAN ACCOMMODATE SURFACE VARIATIONS AND IRREGULARITIES.
 - CONTRACTOR TO PROPOSE AND FIELD VERIFY CONNECTIONS BY TESTING TO EXISTING SUBSTRATE. CONNECTION/FASTENING DESIGN AND DETAILS TO BE STAMPED BY A PROFESSIONAL ENGINEER AND SUBMITTED PRIOR TO CONSTRUCTION.
- CLADDING
 - INSTALL METAL CLADDING ASSEMBLY. (SEE DRAWINGS A-0 THROUGH A-5)
- WINDOWS
 - REPLACE WOOD INFILL PANELS AT WINDOW TRANSOMS AND SIDELITES WITH INSULATED ALUMINUM PANELS, SIMILAR TO THE WINDOW ON REAR ELEVATION. REPLACE SEALANT AROUND PERIMETER OF ALL OPENINGS (WINDOWS AND DOORS).

FOAMED IN PLACE INSULATION

- LOW EXPANSION, ONE COMPONENT FOAM POLYURETHANE, SOLVENT FREE TO CAN/ULC-S705.1
- ACCEPTABLE MATERIAL
 - ENERFOAM, BY DOW CHEMICAL
 - HANDI-FOAM, BY FOMO PRODUCTS
 - CF 128-DW, BY HILTI
- APPLICATION
 - APPLY INSULATION TO CLEAN SURFACES IN ACCORDANCE WITH THE MANUFACTURER'S PRINTED INSTRUCTIONS. USE PRIMER WHEN RECOMMENDED BY THE MANUFACTURER.
 - APPLY FOAM-IN-PLACE TO SEAL AIR SPACE BETWEEN METAL LINER AND 'FOAMCRETE' BUILDING TO FORM A CONTINUOUS AIR BARRIER.

SEALANT

- PERIMETER SEALANT:
 - PERIMETERS OF EXTERIOR OPENINGS WHERE FRAME MEET EXTERIOR FAÇADE OF BUILDING.
 - URETHANES ONE PART:
 - NON-SAG TO CAN/CCSB-19.13, TYPE 2, MCG-2-25. COLOUR TO BE SELECTED
 - ACCEPTABLE MATERIAL
 - TREMCO DYMONIC.
 - SONNEBORN NP 1.
 - SINKAFLEX 1A.
- APPLICATION
 - APPLY SEALANTS IN ACCORDANCE WITH MANUFACTURER'S WRITTEN INSTRUCTIONS.
 - MASK EDGES OF JOINTS WHERE IRREGULAR SURFACE OR SENSITIVE JOINT BOARDER EXIST TO PROVIDE NEAR JOINT.
 - APPLY SEALANT IN CONTINUOUS BEAD.
 - APPLY SEALANT USING GUN WITH PROPER SIZE NOZZLE.
 - USE SURFACE PRESSURE TO FILL VOIDS AND JOINTS SOLID.
 - FORM SURFACE OF SEALANT WITH FULL BEAD, SMOOTH, FREE FROM RIDGES, WRINKLES, SAGS, AIR POCKETS, EMBEDDED IMPURITIES.
 - TOOL EXPOSED SURFACE BEFORE SKINNING BEGINS. GIVE SLIGHTLY CONCAVED SHAPE.
 - REMOVE EXCESSIVE COMPOUND PROMPTLY AS WORK PROGRESSES AND UPON COMPLETION.
- CURING
 - CURE SEALANTS IN ACCORDANCE WITH MANUFACTURER'S INSTRUCTIONS.
 - DO NOT COVER UP SEALANTS UNTIL PROPER CURING HAS TAKEN PLACE.
- CLEANUP

- CLEAN ADJACENT SURFACES IMMEDIATELY AND LEAVE WORK NEAR AND CLEAN
- REMOVE EXCESS AND DROPPINGS, USING RECOMMENDED CLEANERS AS WORK PROGRESSES.
- REMOVE MASKING TAPE AFTER INITIAL SET OF SEALANT.

INSULATION

- SEMI-RIGID INSULATION
 - CAVITY WALL INSULATION: UNFACED, PREFORMED RIGID FIBROUS MINERAL SLAG BOARD INSULATION IN ACCORDANCE WITH CAN/ULC S702, AND AS FOLLOWS:
 - ASTM C612 TYPE IVB.
 - THERMAL RESISTANCE: RSI 0.76/25 MM (R-4.3) MINIMUM.
 - COMBUSTION CHARACTERISTICS: NON-COMBUSTIBLE IN ACCORDANCE WITH CAN/ULC S114.
 - FLAMESPREAD: '0' IN ACCORDANCE WITH CAN/ULC S102.
 - SMOKE DEVELOPED: '0' IN ACCORDANCE WITH CAN/ULC S102.
 - DENSITY: 70 KG/M3.
 - EDGES: SQUARE.
 - SIZE: 406 MM X 1220 MM X THICKNESS AS INDICATED ON DRAWINGS.
 - ACCEPTABLE MATERIALS:
 - FIBREX, CWB 45.
 - ROXUL, CAVITYROCK.
 - OR APPROVED ALTERNATIVE
 - ACCESSORIES:
 - INSULATION CLIPS: IMPALE TYPE, PERFORATED 50 X 50 MM COLD ROLLED CARBON STEEL 0.8 MM THICK, ADHESIVE-BACK, SPINDLE OF 2.5 MM DIAMETER HOT DIP GALVANIZED STEEL, LENGTH TO SUIT INSULATION, 25 MM DIAMETER WASHERS OF SELF-LOCKING TYPE.
- RIGID BOARD INSULATION
 - INSULATION FOR APPLICATION AT PERIMETER FOUNDATION WALLS, AS INDICATED:
 - EXTRUDED POLYSTYRENE (XPS): TO CAN/ULC-S701.
 - TYPE: 4.
 - MINIMUM COMPRESSIVE STRENGTH: 210 KPA (30 PSI).
 - THICKNESS: AS INDICATED.
 - EDGES: SHIPLAPPED.
 - ACCEPTABLE MATERIAL:
 - CELFORT 300.
 - STYROFOAM SM.
 - APPROVED ALTERNATE.
 - ADHESIVE
 - ADHESIVE (FOR POLYSTYRENE): TO CGSB 71-GP-24.
 - TYPE: COMPATIBLE WITH WATERPROOFING MEMBRANE AND THROUGH WALL FLASHINGS.
 - ACCESSORIES
 - FASTENERS: CORROSION RESISTANT TREATED, SELF TAPPING ANCHORS AS RECOMMENDED BY THE INSULATION MANUFACTURER, SUITABLE FOR CONCRETE. LENGTH TO BE 25MM LONGER THAN THE TOTAL THICKNESS OF THE INSULATION.
 - PERIMETER PROTECTION BOARD
 - 13MM THICK PORTLAND CEMENT COMPOSITE PANEL, REINFORCED WITH SYNTHETIC FIBRES AND ADDITIVES SUITABLE FOR EXTERIOR USE AT AND BELOW GRADE AS INDICATED, TEXTURED FINISH.
 - FASTENERS
 - ACCEPTABLE MATERIALS:
 - TAPCONS BY ITW
 - APPROVED ALTERNATIVE
 - ACCEPTABLE MATERIAL:
 - FINEX MULTI-PURPOSE FIBER CEMENT PANELS, TEXTURED FINISH, AS AVAILABLE FROM FINEX, 24 ST-LOUIS, SUITE 130, SALABERRY-DE-VALLEYFIELD, QUEBEC, J6T 1M4; WWW.GOFINEX.COM
 - OR APPROVED ALTERNATIVE

PREFORMED METAL CLADDING

- METAL CLADDING ASSEMBLY:
 - GALVANIZED DOUBLE GIRT ASSEMBLY, SECURED TO EXISTING 'FOAMCRETE' WALLS
 - GALVANIZED METAL LINER PANEL (AIR/VAPOUR BARRIER)
 - 4" SEMI-RIGID CAVITY INSULATION
 - GALVANIZED METAL GIRTS
 - 1/2" AIR SPACE
 - PRE-FINISHED METAL CLADDING
 - PRE-FINISHED METAL FLASHING AND TRIMS
- MATERIALS:
 - METAL SIDING (SEE DRAWINGS FOR LOCATION):
 - PREFABRICATED EXTERIOR PANEL, 7/8" CORRUGATED PROFILE, ZINC COATED SHEET STEEL, PRODUCED IN ACCORDANCE WITH ASTM A653/A653M S.S., Z-275 (G90) GALVANIZING, GR. 33 (GR. 230) 24ga (0.024") THICK EXCLUDING FINISH COAT.
 - TOPCOAT FINISH TO BE 4 COAT PVDF (POLYVINYLIDENE FLOURIDE) SYSTEM WITH A MINIMUM TOTAL TOPCOAT DFT OF 1.6mil COMPRISED OF 0.08-1.20mil PCDF PRIMER AND A 0.8mil PVDF COLOUR COAT.
 - COLOURS (SEE DRAWINGS FOR LOCATION):
 - CL1: BAYCOAT 10000 SERIES, SLATE BLUE, 16067.
 - CL2: BAYCOAT 10000 SERIES, BONE WHITE, 16069.
 - ACCEPTABLE MATERIALS:
 - VIC WEST 7/8" CORRUGATED PROFILE

- AGWAY METALS 7/8" CORRUGATED PROFILE
- APPROVED ALTERNATE
- COMPONENTS:
 - SUB-GIRTS: OF SUITABLE MINIMUM BASE METAL THICKNESS, STRUCTURAL QUALITY STEEL TO ASTM A 653, WITH Z275 ZINC COATING TO ASTM A 792, PROFILE AS INDICATED TO ACCEPT EXTERIOR SHEET WITH STRUCTURAL ATTACHMENT TO BUILDING COMPONENT. MINIMUM SUB-GIRT THICKNESS TO BE 16 ga.
 - SHEET METAL LINER: ZINC COATED SHEET STEEL, PRODUCED IN ACCORDANCE WITH ASTM A653 / A653M S.S., Z-275 (G90), GR. 33 (GR. 230), 26 GA. (0.018") (0.455 MM) THICK. PLAIN GALVANIZED FINISH BOTH SIDES.
 - FASTENERS
 - SUB-GIRT FASTENERS
 - ACCEPTABLE MATERIAL:
 - BUILDEX CLIMASEAL #17, TEKDRILLER
 - APPROVED ALTERNATIVE
 - SUB-GIRT FASTENERS INTO 'FOAMCRETE' WALL
 - CONTRACTOR TO PROPOSE AND FIELD VERIFY CONNECTIONS BY TESTING TO EXISTING SUBSTRATE. CONNECTION/FASTENING DESIGN AND DETAILS TO BE STAMPED BY A PROFESSIONAL ENGINEER AND SUBMITTED PRIOR TO CONSTRUCTION.
 - ACCEPTABLE MATERIALS:
 - TAPCONS BY ITW.
 - APPROVED ALTERNATIVE
 - ACCESSORIES:
 - EXPOSED JOINT: ENDS OF CLADDING SHEET SHOP CUT CLEAN AND SQUARE, BACKED WITH TIGHT FITTING FILLER LAPPING BACK OF JOINT.
 - ACCESSORIES: CAP FLASHING, DRIP FLASHINGS, COPINGS AND CLOSURES FOR HEAD, JAMB, SILL AND CORNERS, OF SAME MATERIAL, THICKNESS AND FINISH AS EXTERIOR CLADDING, BRAKE FORMED TO SHAPE, AS SHOWN IN DRAWINGS. COLOURS TO MATCH ADJACENT CLADDING UNLESS OTHERWISE NOTED.
- FOAM CLOSURES: POLYETHYLENE COMPRESSIVE FOAM CLOSURE STRIP TO MATCH PROFILES (2lbs/cu.ft. OF DENSITY).
 - ACCEPTABLE MATERIAL:
 - GOODCO EVALITE CROSS LINK POLYETHYLENE #12207.
- SEALANT: THERMOPLASTIC, ELASTOMER-BASED, SOLVENT CURING SEALANT, ACCORDING TO THE CAN/CCSB-19.0-M AND ASTM C794 AND ASTM C719 REGARDING ADHESION AND DURIBILITY.
 - ACCEPTABLE MATERIALS:
 - DYMONIC 1 PART POLYURETHANE SEALANT
 - SONOLASTIC NPI BY BASF.
- FASTENERS:
 - ALL SCREWS SHOULD NE IN ACCORDANCE WITH THE MANUFACTURERS STANDARDS AND MEET THE ANSI B18.6.4 AND CSA B-35.31962 SPECIFICATIONS. EXPOSED FASTENERS TO BE #14 ATLAS NYLON HEAD COMPLETE WITH DISHED NEOPRENE AND STAINLESS STEEL WASHERS. SCREW HEADS TO MATCH COLOUR OF CLADDING.

INSULATED INFILL PANELS

- INSULATED PANELS OF 1.5MM ALUMINUM SHEET BONDED TO OUTER FACE OF RIGID URETHANE INSULATION WITH 22GA. GALVANIZED STEEL BONDED TO INNER FACE; 25MM OVERALL THICKNESS. MATCH COLOUR TO EXISTING ALUMINUM INFILL PANELS.



FOWLER BAULD & MITCHELL
architecture

Fowler Bauld & Mitchell Ltd.
PO Box 514, Halifax, Nova Scotia B3J 2R7
HS1-1660 Hollis Street, Halifax, Nova Scotia B3J 1V7
Tel: 902 429 4100 Fax: 902 423 3063
email: architects@fbm.ca www.fbm.ca

STAMP



No.	REVISION	BY	DATE
1	ISSUED FOR TENDER	MDG	AUG 19/16

TERENCE BAY RE-CLADDING
TERENCE BAY, N.S.

JOB 2015-117 DATE 05 AUG 2016
CLIENT HALIFAX REGIONAL SCHOOL BOARD

GENERAL NOTES

A-0

DWN JAD CHK GAC SCALE

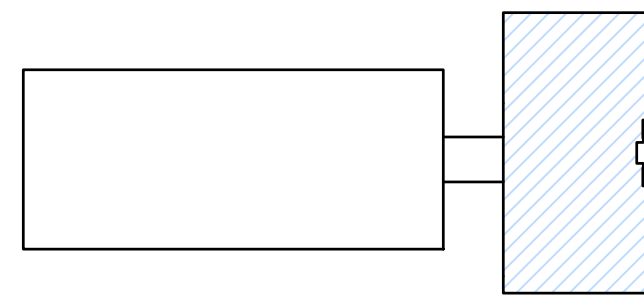
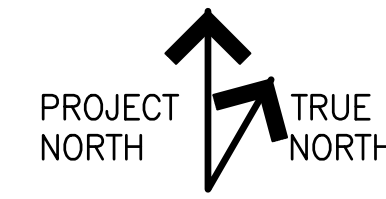
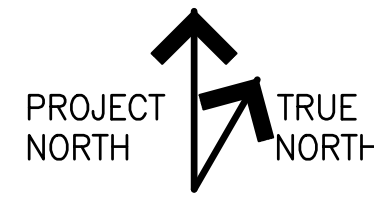

KEY PLAN

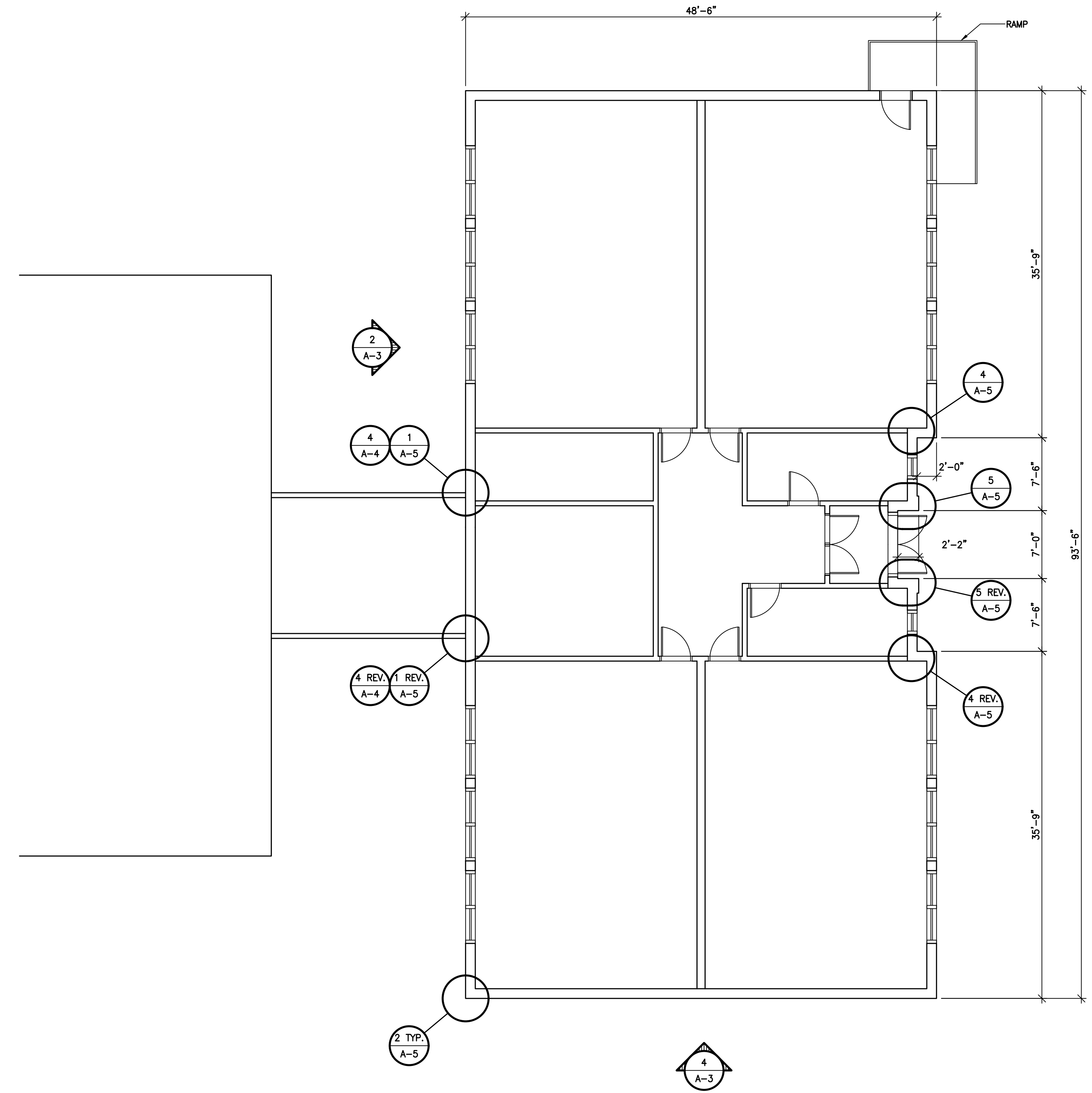
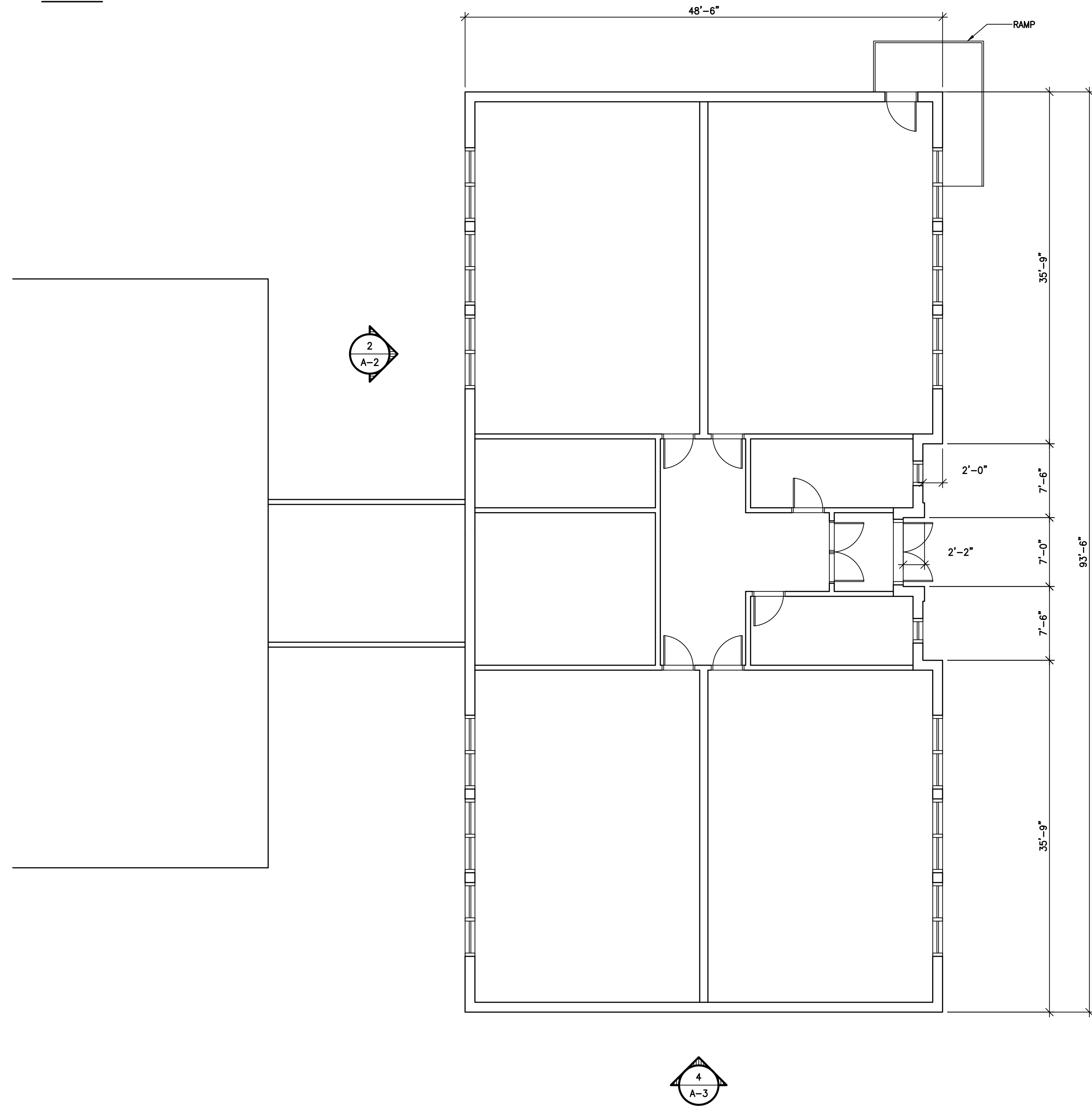

1 FLOOR PLAN - EXISTING CONDITIONS

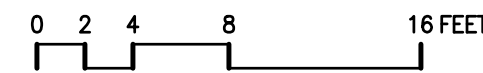

2 FLOOR PLAN - NEW CONDITIONS

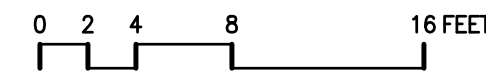

PLAN FOR LOCATION REFERENCE ONLY

ALL DIMENSIONS APPROXIMATE

FOWLER BAULD & MITCHELL
architecture

Fowler Bauld & Mitchell Ltd.
PO Box 514, Halifax, Nova Scotia B3J 2R7
H51-1660 Hollis Street, Halifax, Nova Scotia B3J 1V7
Tel: 902 429 4100 Fax: 902 423 3063
email: architects@fbm.ca www.fbm.ca

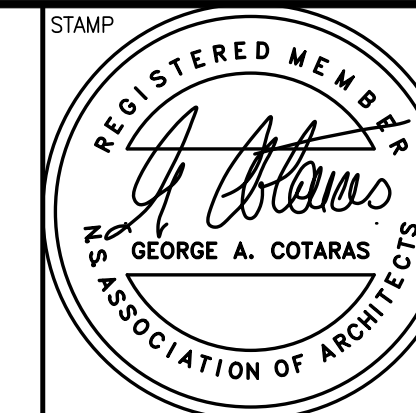

No.	REVISION	BY	DATE
1	ISSUED FOR TENDER	MDG	AUG 19/16

TERENCE BAY RE-CLADDING
TERENCE BAY, N.S.

JOB 2015-117 DATE 05 AUG 2016
CLIENT HALIFAX REGIONAL SCHOOL BOARD

FLOOR PLANS

A-1

DWN JAD CHK GAC SCALE 1/8"=1'-0"

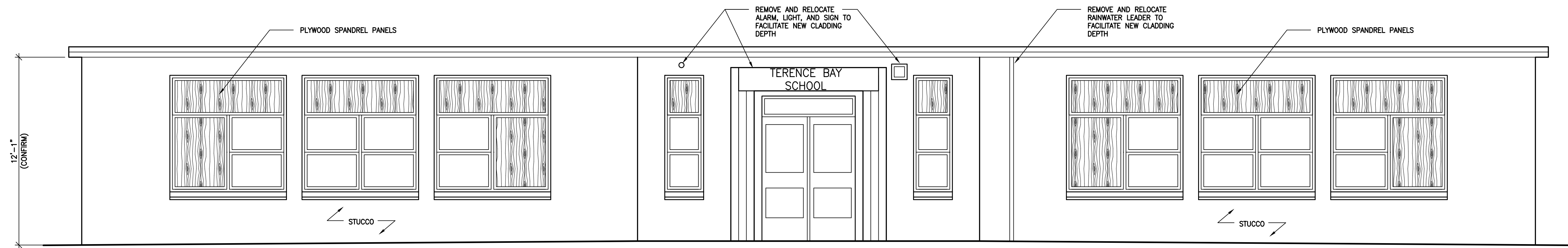

1 FRONT ELEVATION – EXISTING CONDITIONS

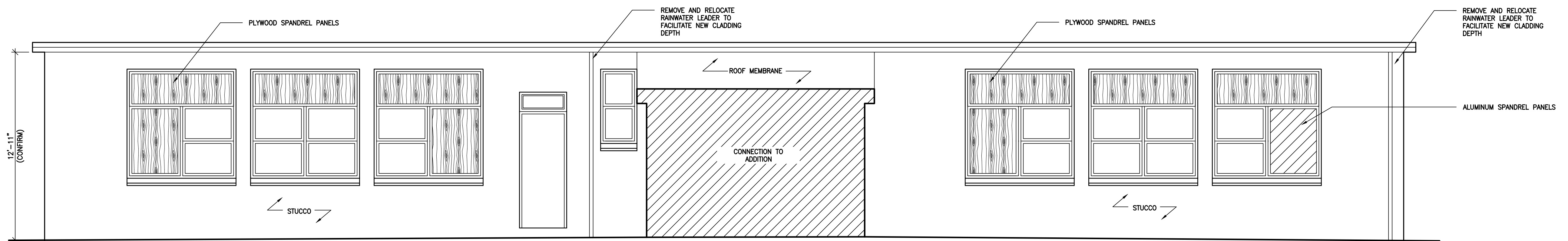
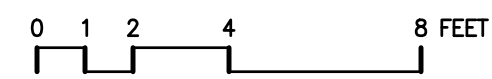

2 REAR ELEVATION – EXISTING CONDITIONS

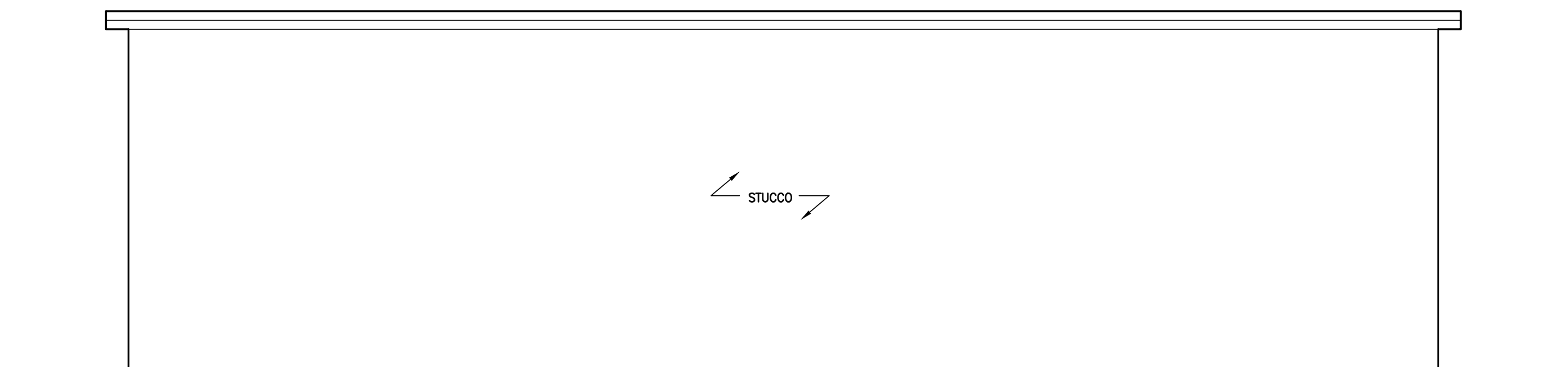
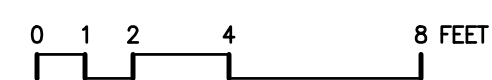

3 SIDE ELEVATION (NORTH) – EXISTING CONDITIONS

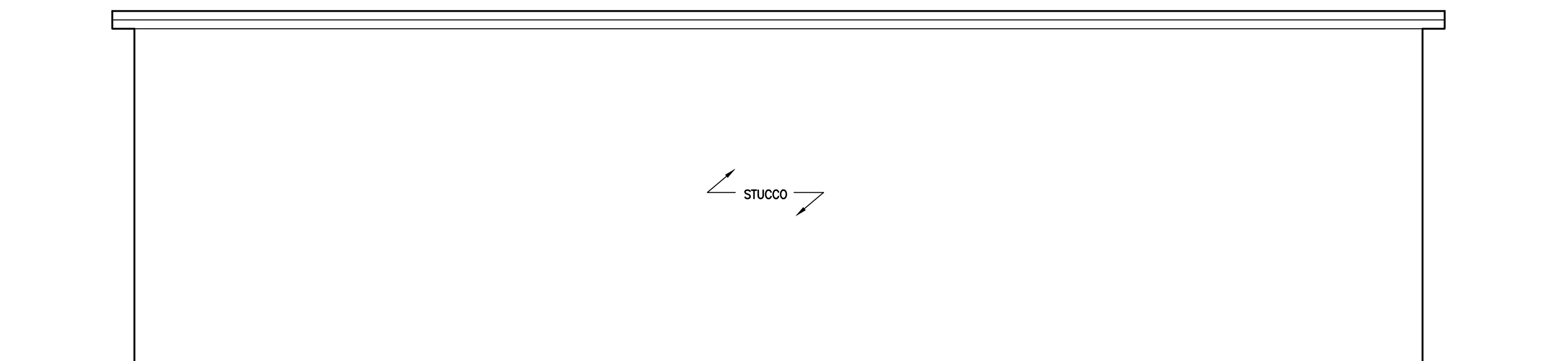
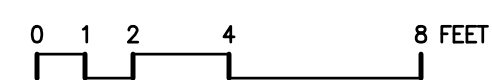

4 SIDE ELEVATION (SOUTH) – EXISTING CONDITIONS

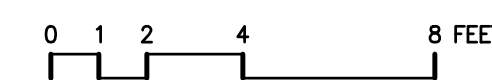

No.	REVISION	BY	DATE
1	ISSUED FOR TENDER	MDG	AUG 19/16

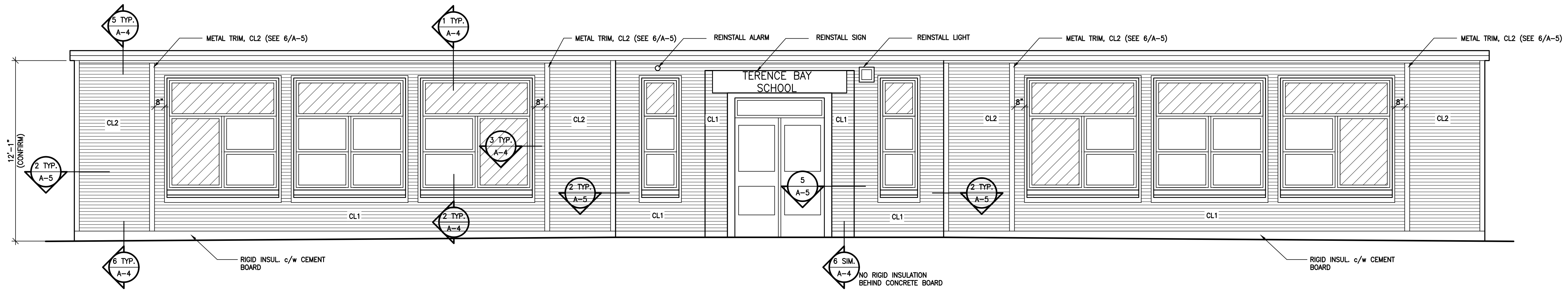

REPLACE ALL PLYWOOD INFILL PANEL w/ INSULATED ALUMINUM PANELS. MATCH INSULATED ALUMINUM PANELS TO EXISTING ALUMINUM PANELS ON REAR OF BUILDING. VERIFY PANEL DIMENSIONS ON SITE.

CLADDING LEGEND
 CL1 SLATE BLUE
 CL2 BONE WHITE

NOTES:
 1. RAINWATER LEADERS NOT SHOWN FOR CLARITY
 2. REINSTALL ALARM, LIGHT FIXTURE, SCHOOL SIGN ON TO THE NEW CLADDING.

1 FRONT ELEVATIONS – NEW CONDITIONS

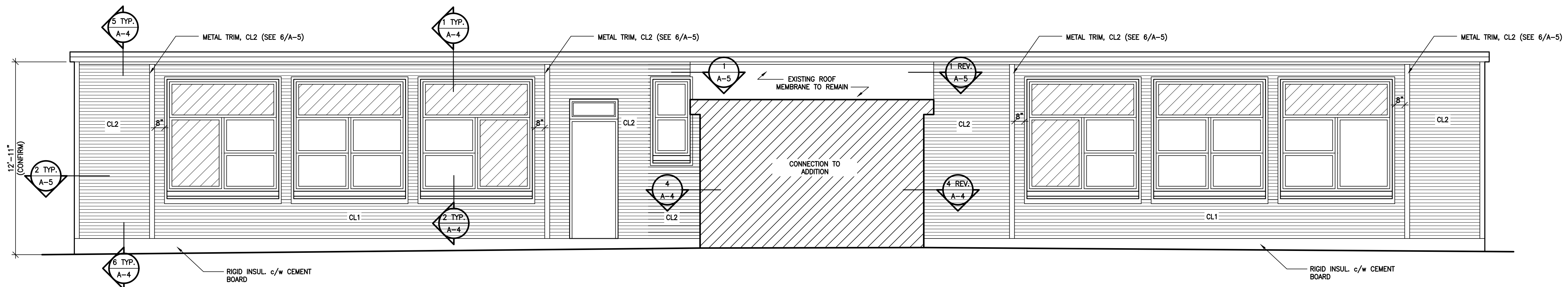
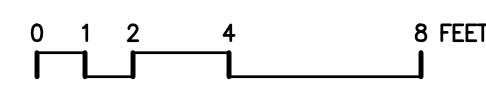

REPLACE ALL PLYWOOD INFILL PANEL w/ INSULATED ALUMINUM PANELS. MATCH INSULATED ALUMINUM PANELS TO EXISTING ALUMINUM PANELS ON REAR OF BUILDING. VERIFY PANEL DIMENSIONS ON SITE.

CLADDING LEGEND
 CL1 SLATE BLUE
 CL2 BONE WHITE

NOTES:
 1. RAINWATER LEADERS NOT SHOWN FOR CLARITY
 2. REINSTALL ALARM, LIGHT FIXTURE, SCHOOL SIGN ON TO THE NEW CLADDING.

2 REAR ELEVATION – NEW CONDITIONS

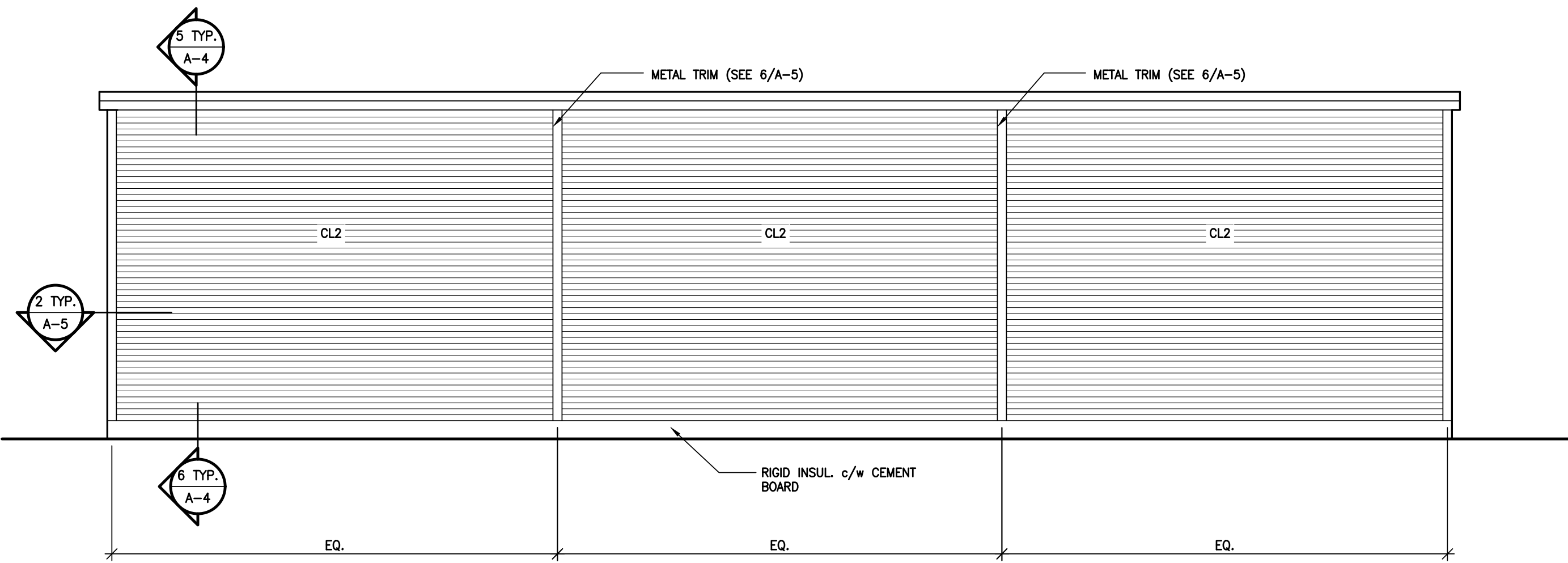
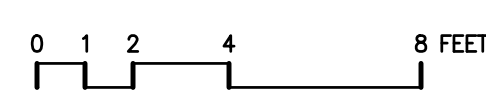

3 SIDE ELEVATION (NORTH) – NEW CONDITIONS

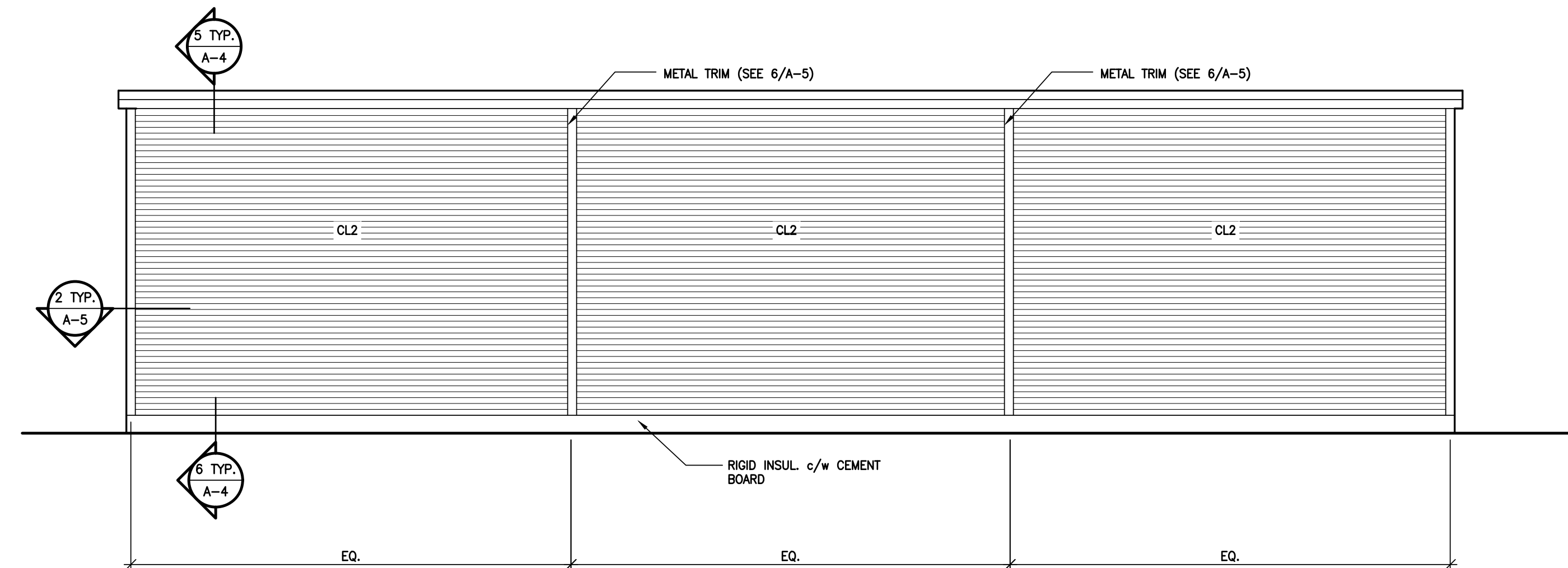
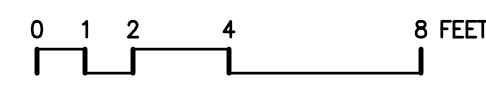

4 SIDE ELEVATION (SOUTH) – NEW CONDITIONS

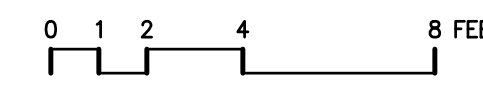

FOWLER BAULD & MITCHELL
 architecture

Fowler Bauld & Mitchell Ltd.
 PO Box 514, Halifax, Nova Scotia B3J 2R7
 HSI-1660 Hollis Street, Halifax, Nova Scotia B3J 1V7
 Tel: 902 429 4100 Fax: 902 423 3063
 email: architects@fbm.ca www.fbm.ca

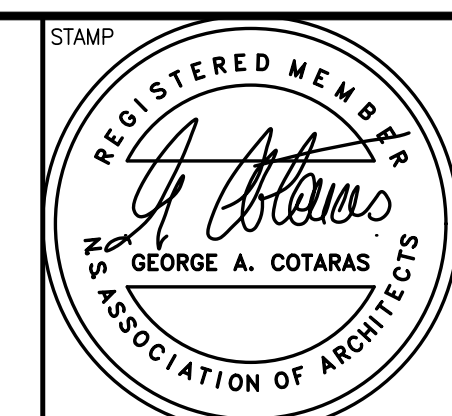

No.	REVISION	BY	DATE
1	ISSUED FOR TENDER	MDG	AUG 19/16

TERENCE BAY RE-CLADDING
 TERENCE BAY, N.S.

JOB 2015-117 DATE 05 AUG 2016
 CLIENT HALIFAX REGIONAL SCHOOL BOARD

BUILDING ELEVATIONS: NEW CONDITIONS

A-3

DWN JAD CHK GAC SCALE 1/4"=1'-0"

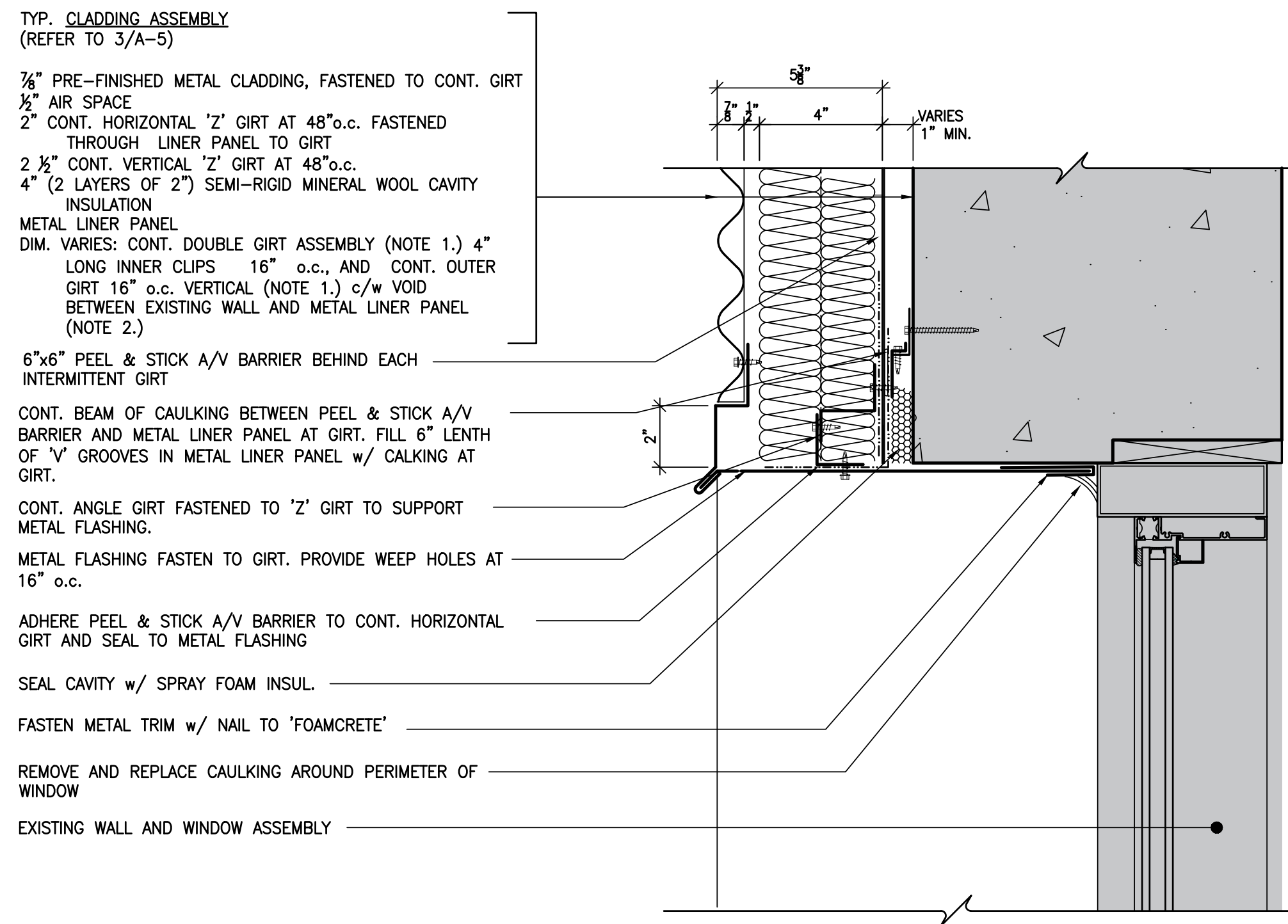

1 SECTION DETAIL - CLADDING AT WINDOW HEAD
0 1" 2" 4" 8"

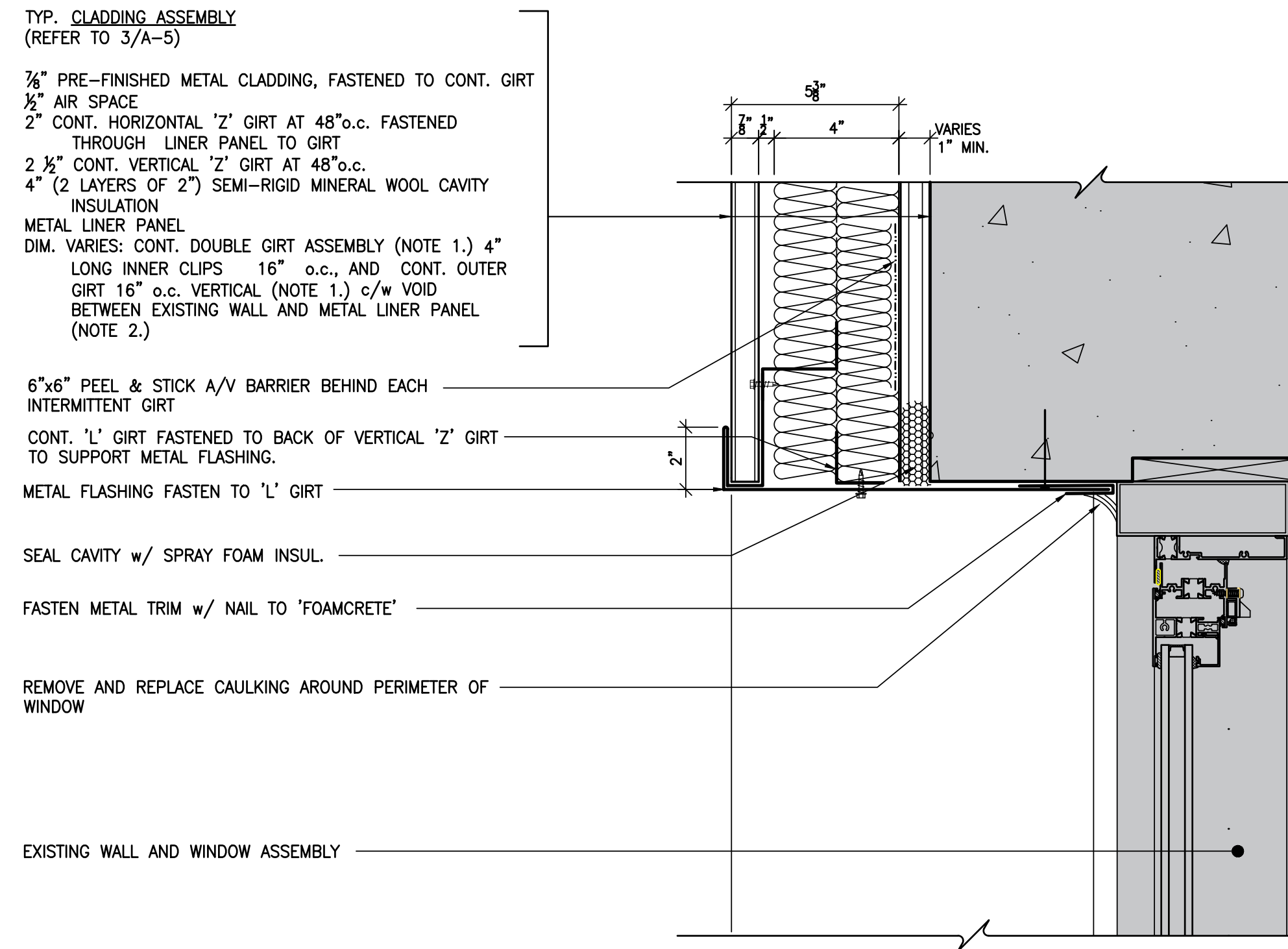

3 PLAN DETAIL - CLADDING AT WINDOW JAMB
0 1" 2" 4" 8"

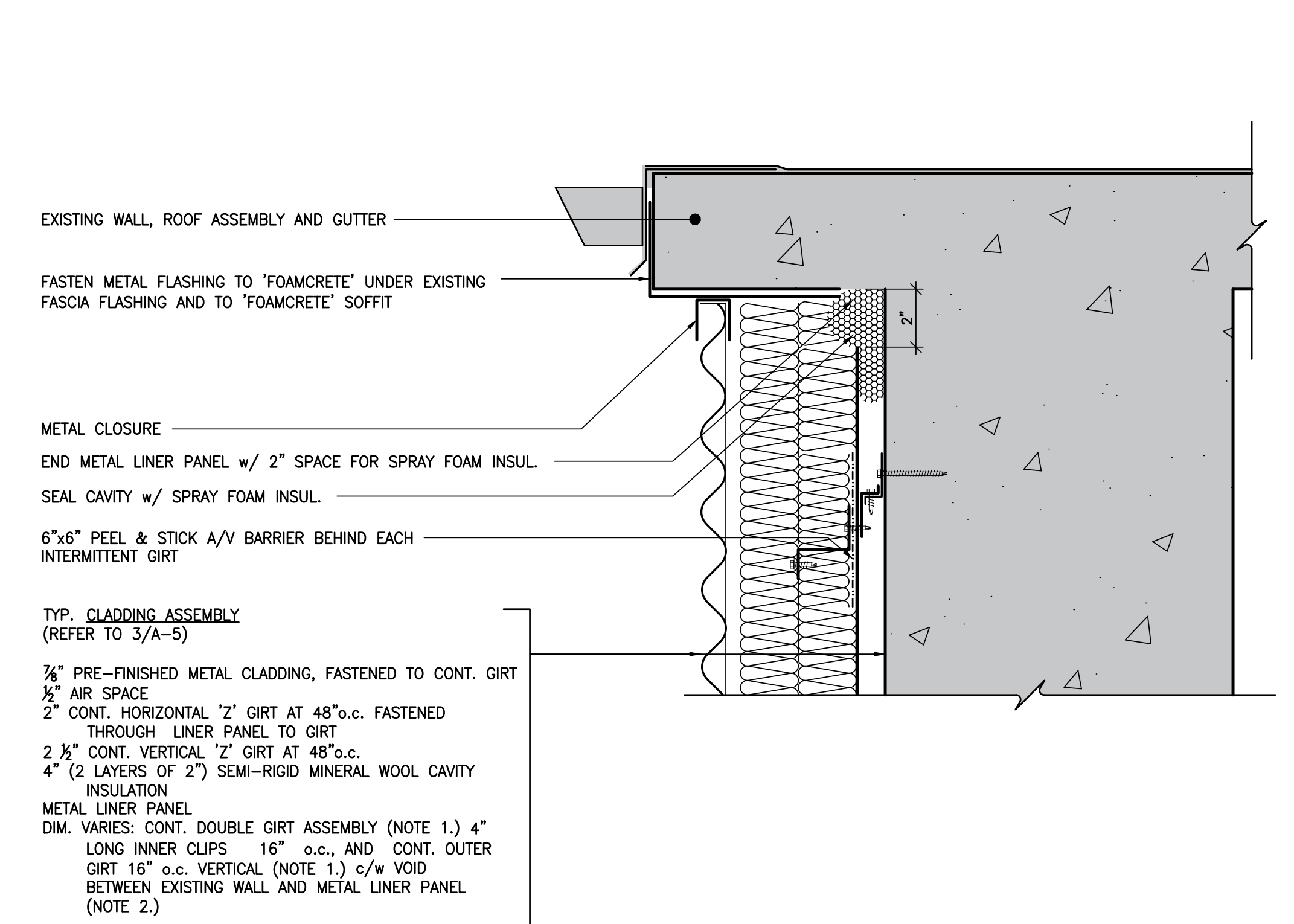

5 SECTION DETAIL - CLADDING AT ROOF EDGE
0 1" 2" 4" 8"

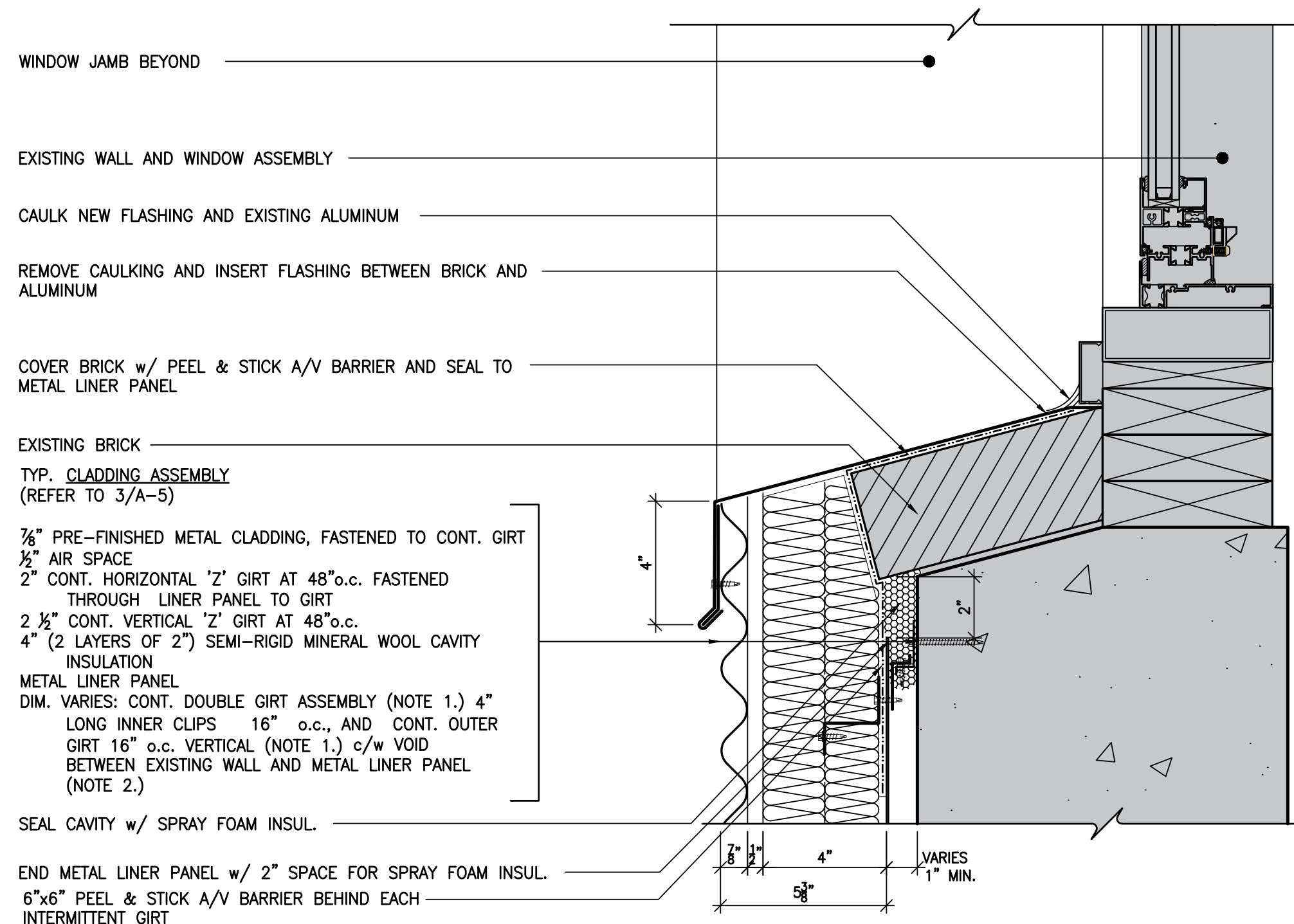

2 SECTION DETAIL - CLADDING AT WINDOW SILL
0 1" 2" 4" 8"

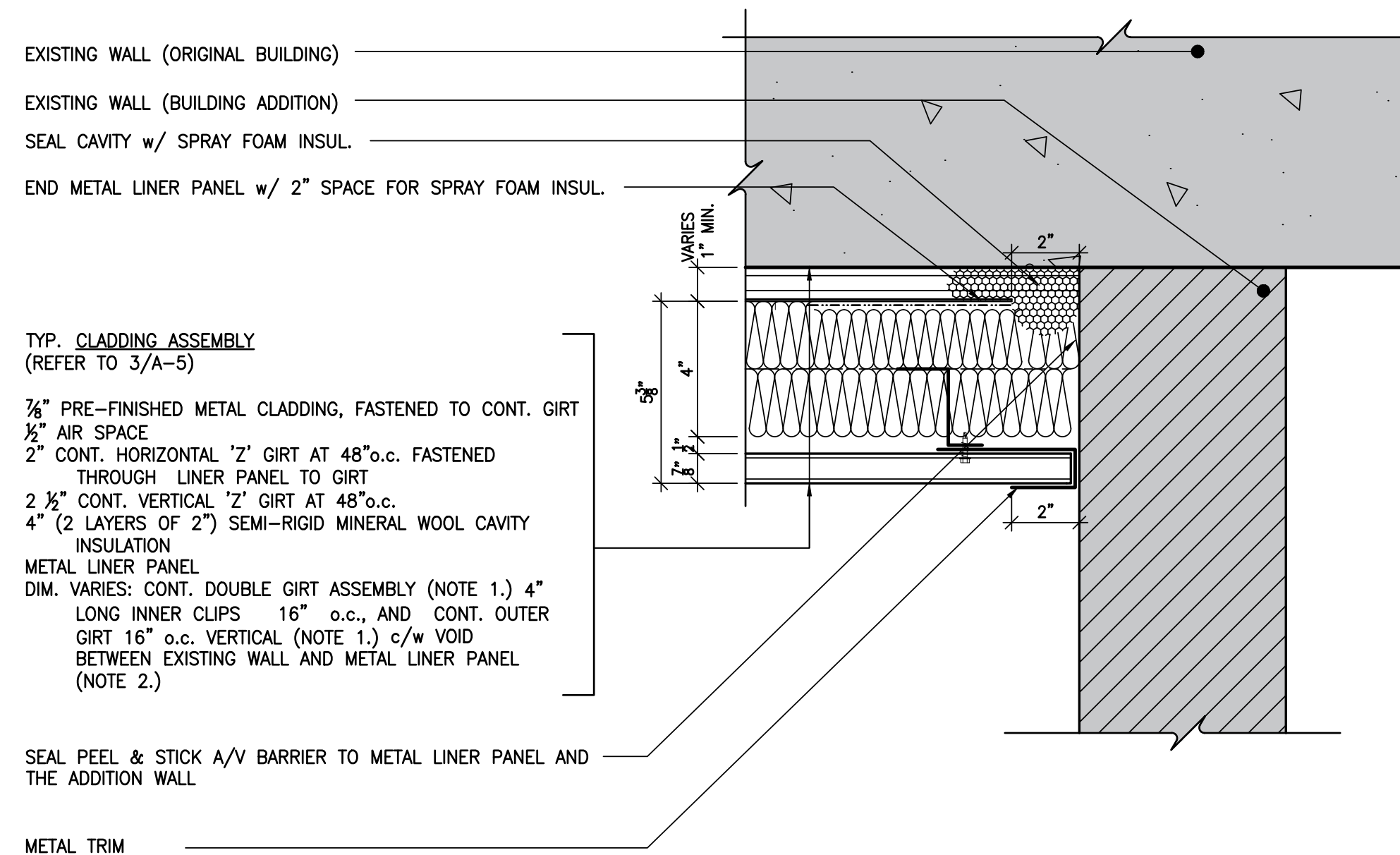

4 PLAN DETAIL - CLADDING AT CONNECTION TO BUILDING ADDITION
0 1" 2" 4" 8"

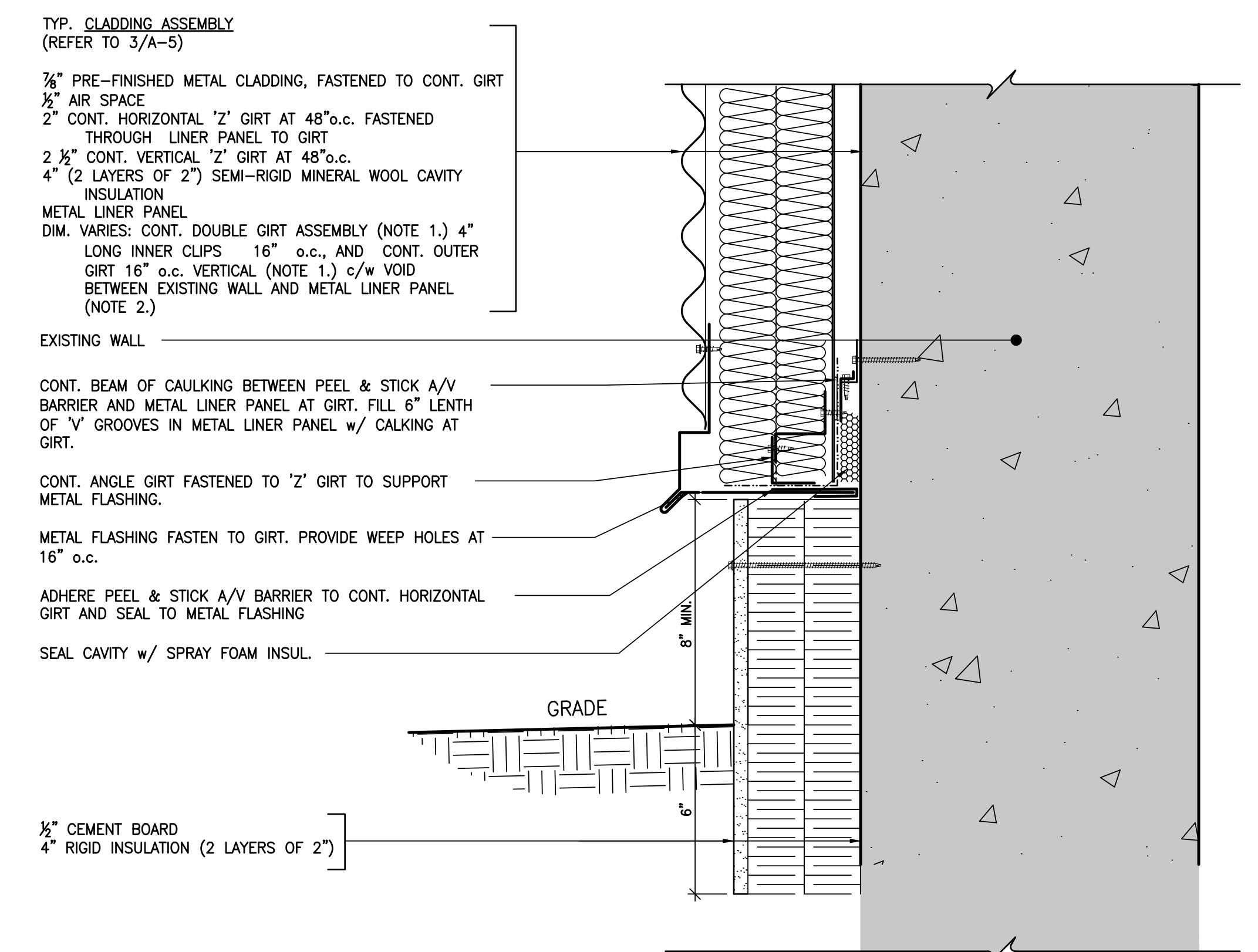

6 SECTION DETAIL - CLADDING AT GRADE
0 1" 2" 4" 8"

FOWLER BAULD & MITCHELL
architecture

Fowler Bauld & Mitchell Ltd.
PO Box 514, Halifax, Nova Scotia B3J 2R7
H51-1660 Hollis Street, Halifax, Nova Scotia B3J 1V7
Tel: 902 429 4100 Fax: 902 423 3063
email: architects@fbm.ca www.fbm.ca

STAMP
REGISTERED MEMBER
GEORGE A. COTARAS
ASSOCIATION OF ARCHITECTS

No.	REVISION	BY	DATE
1	ISSUED FOR TENDER	MDG	AUG 19/16

TERENCE BAY RE-CLADDING
TERENCE BAY, N.S.

JOB 2015-117 DATE 05 AUG 2016
CLIENT HALIFAX REGIONAL SCHOOL BOARD

CLADDING DETAILS

A-4

DWN JAD CHK GAC SCALE 3"=1'-0"

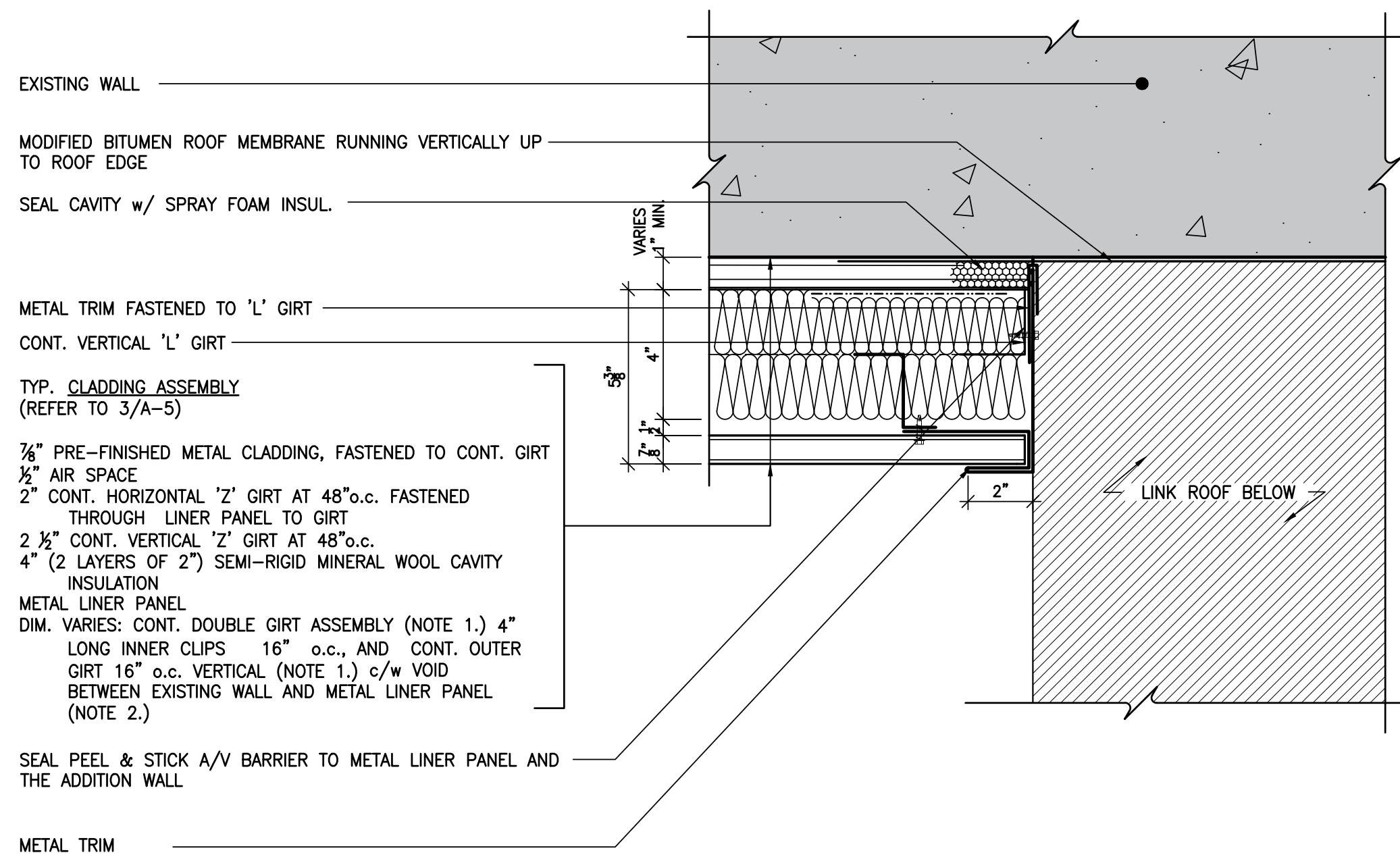

1 PLAN DETAIL - CLADDING AT ROOF MEMBRANE

0 1" 2" 4" 8"

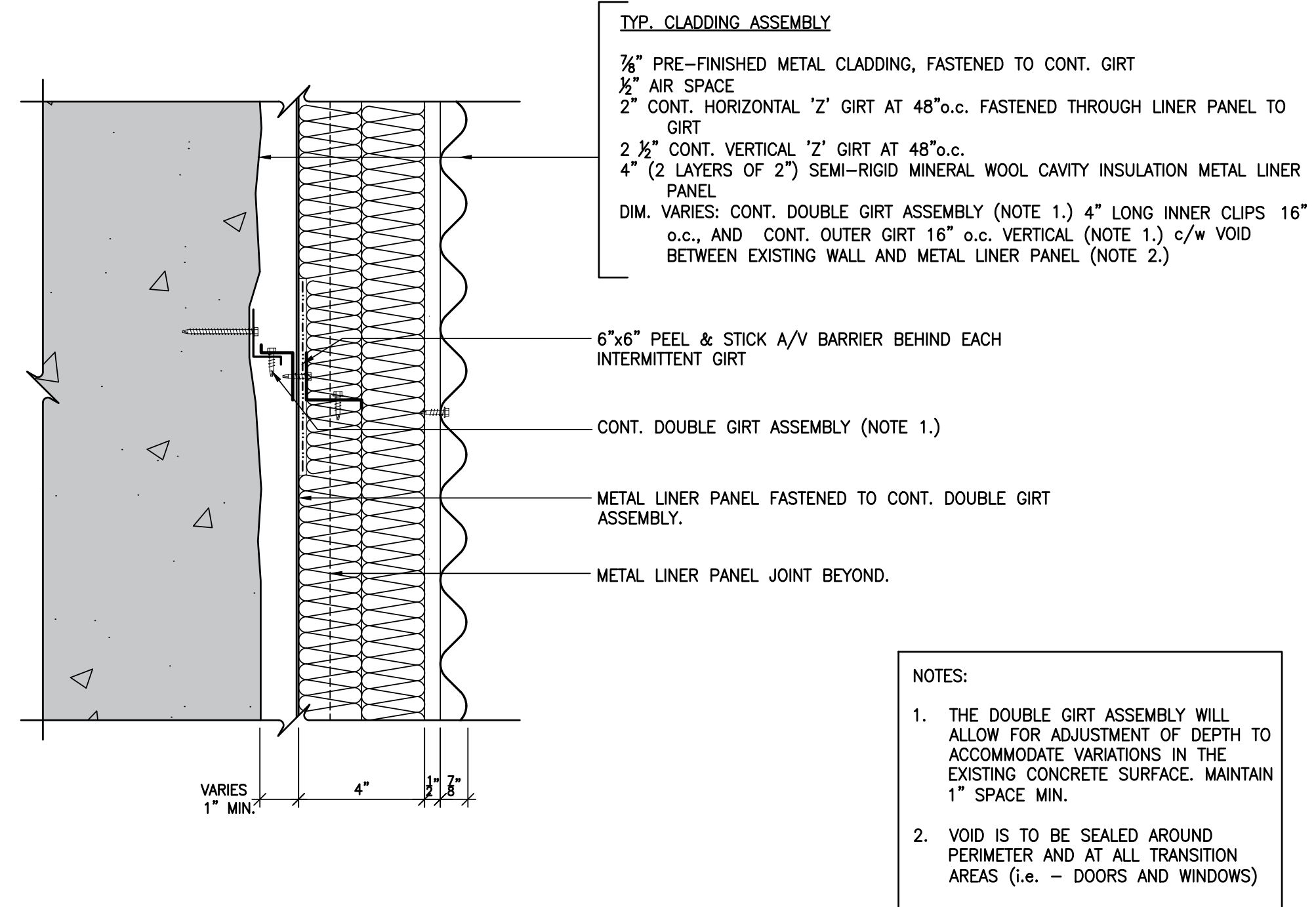

3 SECTION DETAIL - TYPICAL WALL SECTION

0 1" 2" 4" 8"

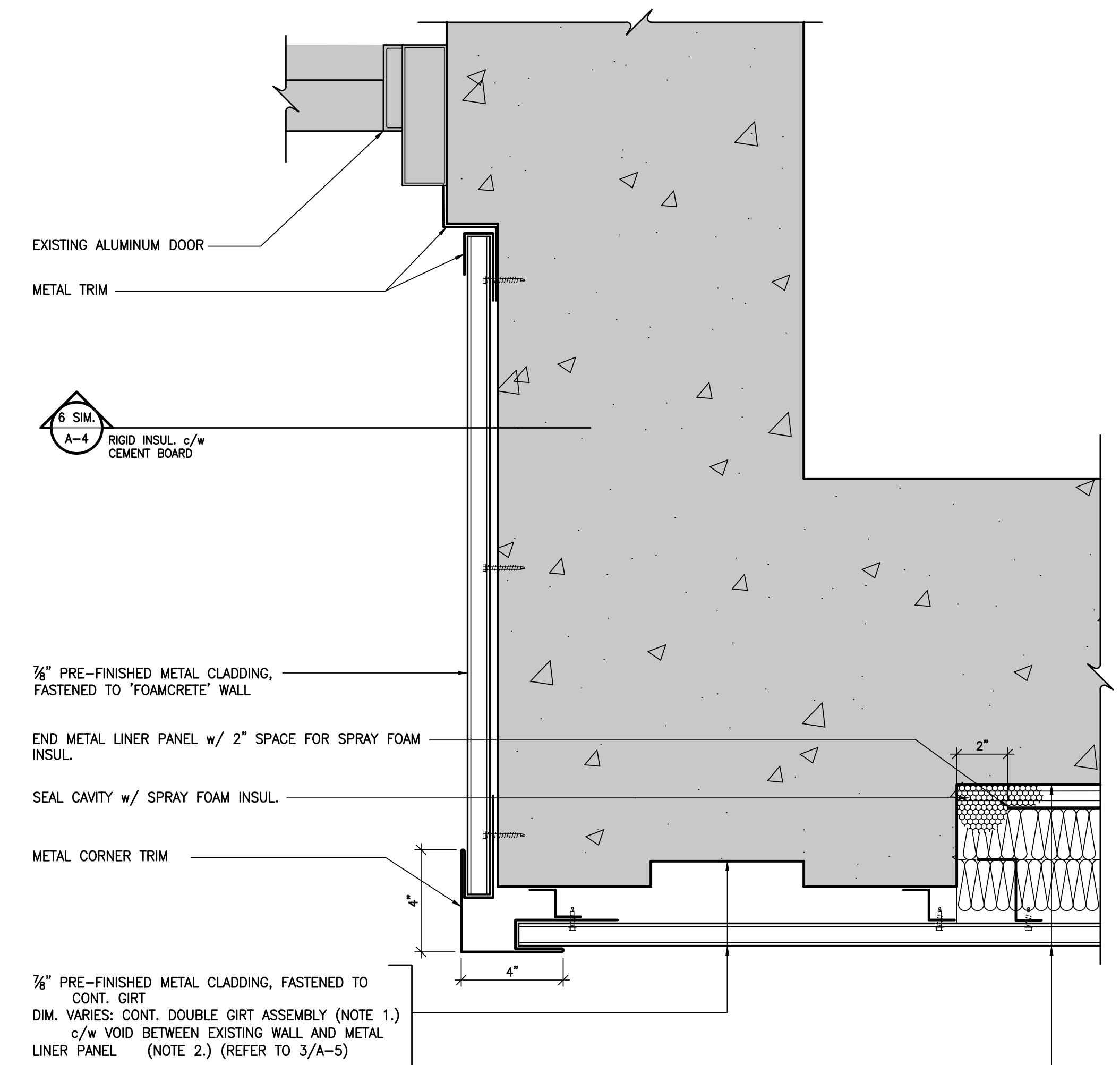

5 PLAN DETAIL - CLADDING AT FRONT ENTRANCE

0 1" 2" 4" 8"

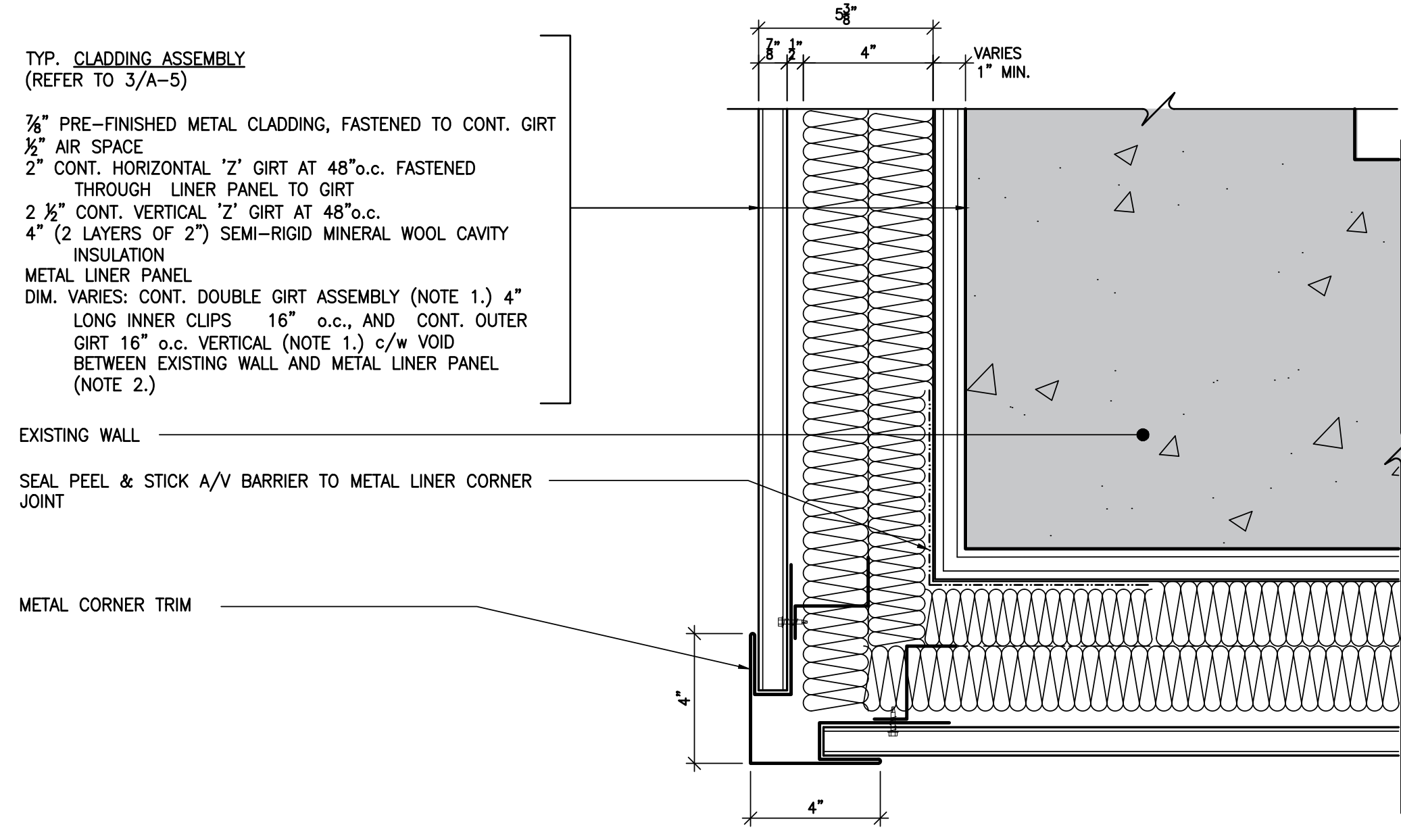

2 PLAN DETAIL - CLADDING AT CORNER

0 1" 2" 4" 8"

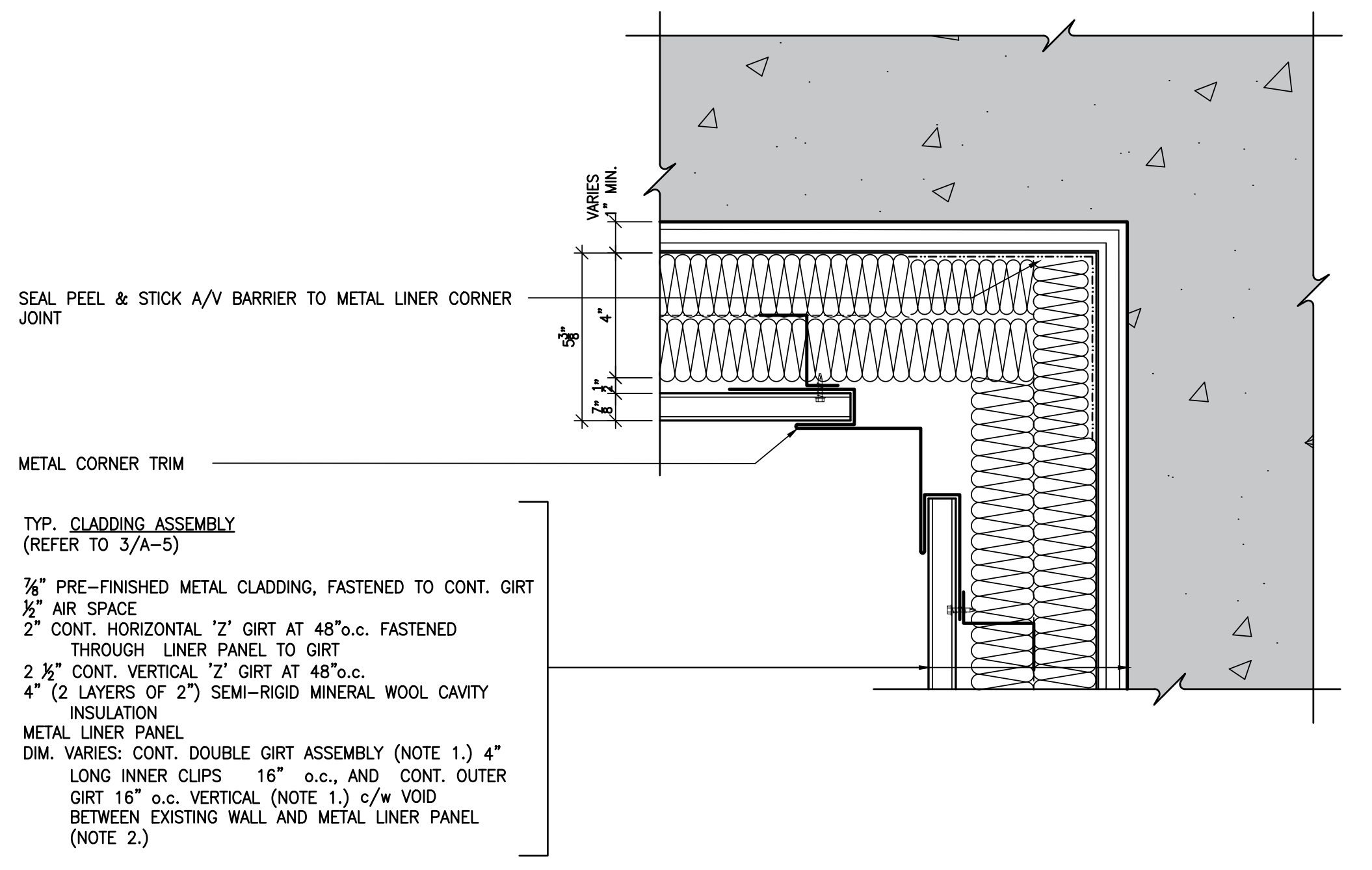

4 PLAN DETAIL - CLADDING AT INSIDE CORNER

0 1" 2" 4" 8"

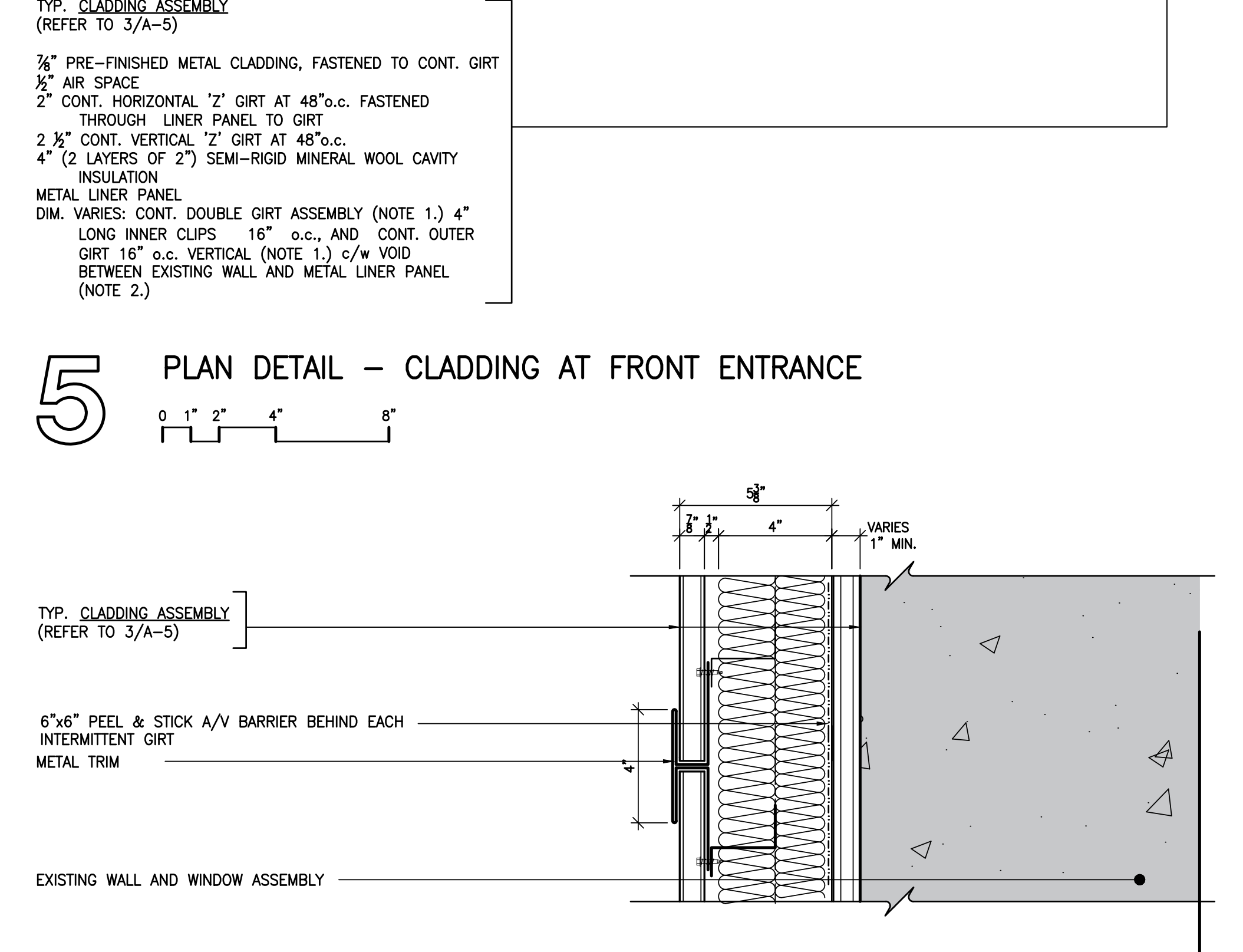

6 PLAN DETAIL - CLADDING AT TRANSITION TRIM

0 1" 2" 4" 8"

FOWLER BAULD & MITCHELL
architecture

Fowler Bauld & Mitchell Ltd.
PO Box 514, Halifax, Nova Scotia B3J 2R7
H51-1660 Hollis Street, Halifax, Nova Scotia B3J 1V7
Tel: 902 429 4100 Fax: 902 423 3063
email: architects@fbm.ca www.fbm.ca

REGISTERED MEMBER
George A. Cotaras
ASSOCIATION OF ARCHITECTS

No.	REVISION	BY	DATE
1	ISSUED FOR TENDER	MDG	AUG 19/16

TERENCE BAY RE-CLADDING
TERENCE BAY, N.S.

JOB 2015-117 DATE 05 AUG 2016
CLIENT HALIFAX REGIONAL SCHOOL BOARD

CLADDING DETAILS

A-5

DWN JAD CHK GAC SCALE 3"=1'-0"