



Halifax Regional
School Board

TENDER #3693

MOD BIT ROOF REPLACEMENTS PACKAGE #1

Closing Date: **TUESDAY, AUGUST 5, 2014**
Closing Time: **2:00:00 P.M.**
Opening Time: **2:00:00 P.M.**

Closing Location:

Halifax Regional School Board
33 Spectacle Lake Drive
Dartmouth, N.S.
B3B 1X7

HRSB Contacts:

Deborah Beck, Buyer
Tel: (902) 464-2000 #2011
Fax: (902) 464-0161

Project Location:

Astral Drive Elem 236 Astral Dr DART. NS
Michael Wallace 24 Andover St DART. NS
Atlantic View 3391 Lawrencetown Rd Lawrencetown NS

Chris Northrup, Manager of Special Projects
Tel: (902) 464-2000 #5116
Fax: (902) 464-2201

A mandatory bidders' site meeting is scheduled for *TUESDAY, JULY 29TH*, *COMMENCING AT ATLANTIC VIEW MAIN ENTRANCE AND THEN CONTINUING TO ASTRAL DRIVE ELEMENTARY AND THEN MICHAEL WALLACE.*

To obtain documents:

Download tender documents in .pdf format from the School Board's Website: www.hrsb.ns.ca "Quick Links/Ask About Tenders".

The Halifax Regional School Board encourages equity and affirmative action programs.

Table of Content

	Page
1.0 Instructions to Bidders	3
1.1 Conditions of Tender	4
1.2 Other Requirements	7
1.5 The Contract	11
2.0 Scope of Work	13
3.0 Contractor’s Information Sheet	23
3.3 Sub Contractor List	24
3.5 Schedule of Prices	26
3.7 Proposed Fixed Price	27

SAMPLE CONTRACT (DO NOT RETURN SAMPLE CONTRACT WITH BID DOCUMENTS)

Schedule “A” Sample Agreement for Supply of Services	29
Appendix “A” Terms and Conditions	31
Appendix “B” Insurance and Risk	42
Appendix “C” Description of Service	48
Appendix “D” Undertaking to Comply & Safety Checklist	51

SAFETY PLAN/CONTRACTOR’S CHECK LIST

Appendix “E” Project Safety Plan Outline	56
Appendix “F” Contractor’s Check List	61

NOTICE – CEASATION OF PUBLIC TENDER OPENINGS

As of April 1, 2014 Public tender openings are no longer held for any tenders relating to goods, services or construction for HRSB. A list of bidders and bid amounts will be posted on the Procurement Services website (<http://novascotia.ca/tenders/tenders/ns-tenders.aspx>) shortly following the closing of the tender. All bid submissions are subject to evaluation after opening and before award of contract. The winning bidder and award amount will be posted on the Procurement Services website (<http://novascotia.ca/tenders/tenders/ns-tenders.aspx>) after evaluation.

1.0 **GENERAL**

The Halifax Regional School Board is seeking bids from qualified suppliers/contractors for a ***MOD BIT ROOF REPLACEMENTS PACKAGE #1 as per the plans and specifications prepared by Architecture 49.***

1.1 **INSTRUCTIONS TO BIDDERS**

**TENDER
SUBMISSION:**

- (a) Sealed Bids will be received by:

Halifax Regional School Board
33 Spectacle Lake Drive
Dartmouth, N.S.
B3B 1X7

Until ***2:00:00 P.M., TUESDAY, AUGUST 5, 2014***, (as verified by the phone clock on the Commissionaire's desk at 33 Spectacle Lake Drive) for the following projects:

TENDER #3693 MOD BIT ROOF REPLACEMENTS – PACKAGE #1

Should the School Board Office be closed for any reason the tender closing will be postponed to the next business day.

- (b) Submit one copy of the original tender on the enclosed tender form. Each item on the form must be completed unless noted otherwise. Bids must be signed by an authorized representative of the Suppliers/Contractors. Incomplete bids will be rejected. Bids must be submitted on or before the advertised time and date in a sealed envelope clearly marked:

TENDER #3693 MOD BIT ROOF REPLACEMENTS – PACKAGE #1

- (c) It is the responsibility of the bidder to ensure their submissions are received on time. Faxed bids will not be accepted.

- (d) Addenda must be issued by the Board no less than three (3) business days before tender closing. Addenda cover letters shall be signed and attached to the tender documents.

1.2 **CONDITIONS OF TENDER**

- (a) No term or condition shall be implied, based upon any industry or trade practice or custom or in a practice or policy of the Board or otherwise, which is inconsistent or conflicts with the provisions contained in these instructions.
- (b) Any changes to this tender or specifications shall be stated by the Board in writing. All correspondence, inquiries, instructions, etc. in connection with the work shall be made through the office of the Halifax Regional School Board, c/o Manager of Accounting & Purchasing or representative.
- (c) Tender price must include freight, duty, and all taxes, rates and charges, which are applicable at the time the contract is awarded. It is the responsibility of the bidder to find out from the appropriate authorities what taxes, rates and charges are applicable to this tender.
- (d) The Contractor is responsible for obtaining all provincial, municipal and other permits as required for the work, and shall adhere to all regulations from regulatory bodies, including the National Building Code, 2005. They shall pay all fees for these permits. Sub-trades are responsible for obtaining permits and following regulations as they affect their work.
- (e) Invoices shall be submitted to: Halifax Regional School Board
c/o Operations Services Coordinator-Maintenance
33 Spectacle Lake Drive,
Dartmouth, NS B3B 1X7

Contact information to be supplied to the successful bidder as part of the award confirmation.

Payment: Payment terms will be considered as Net 30 days from date of invoice.

- (f) Bidders or their employees must not be employees of the Halifax Regional School Board.
- (g) The bidder must comply with Nova Scotia Fire Safety Act and all Municipal Regulations, Ordinances and other laws including the Occupational Health and Safety Act.
- (h) Persons or firms submitting tenders shall be actually engaged in the line of work required by the specifications.
- (i) When applicable, a bidder shall list, in the space provided in Section 3.3, the names of the sub-contractors they propose to use with each sub-contractor's tender price. A change in sub-contractors from this list will require permission in writing from the Board.
- (j) Except as the specifications may be modified by Addenda, the successful

contractor will be held to furnish under this tender all work as specified.

- (k) The contractor shall save, defend, and indemnify the Halifax Regional School Board against all costs which the School Board may sustain or incur by reason of any act or omission of the contractor or its' agents or sub contractors.
- (l) Property loss and/or damage that occurs during the course of work or caused by negligence on the contractors part during the course of the work shall be reported by HRSB Operations Services to the School Insurance Program (SIP) office. Adjusters may be assigned to manage restoration of damaged, defaced or stolen HRSB property. HRSB and/or its insurer reserve the right to assign management of restoration to the adjuster. The contractor shall be responsible for all costs to repair or replace any School Board property, which has been damaged, defaced or stolen during the course of work.
- (m) The term of the contract will be from date of award to ***OCTOBER 31, 2014***.
- (n) Where the Tender Documents stipulate a particular product, written requests for substitutes will be considered by the Board up to five (5) business days prior to the tender closing date. Such requests shall be accompanied by complete descriptive and technical information including MSDS so that a proper evaluation can be made.

When a request for approval of a product is made, the Board may grant approval and will attempt to issue an Addendum to this effect to known bidders. However, HRSB assumes no liability for the delivery of electronic transmissions.

All products used in the course of this work are to be used, stored, and maintained as per the instructions written on the MSDS sheet.

- (o) Time and Material costs must be provided as listed in Section 3.6
- (p) **Unique Logistics**
Completely describe how your Tender will respond to the unique logistics of each school or administrative site as set out in the Project Scope and fully describe, in the same manner, all items of equipment, service, and support you will provide to respond to those logistics and all pricing and other matters relating to them.
- (q) **HRSB Discretion**
The Bidder hereby acknowledges that:
 - a) HRSB shall have the right to reject any or all Tenders for any reason, or to accept any tender which HRSB in its sole, unrestricted discretion deems most advantageous to it. The lowest, or any, Tender will not necessarily be accepted and HRSB shall have the unrestricted right to:
 - i) accept any Tender, and in the event it only receives informal, non-conforming or qualified Tenders with respect to this Tender, accept any such Tender; or

- ii) Accept a Tender that is not the lowest price;
 - iii) Reject a Tender that is the lowest price even if it is the only tender received;
 - iv) Reject any Tender that contains any irregularities, informalities, conditions or qualifications;
 - v) Reject any Tender that is not accompanied by the required tender security documents;
 - vi) Reject any Tender that is not properly signed by or on behalf of the Bidder;
 - vii) Reject any Tender that contains an alteration in a quote that is not initialed by or on behalf of the Bidder;
 - viii) Reject any Tender that is incomplete or ambiguous; or
 - ix) Reject any Tender that does not strictly comply with other requirements contained in these instructions.
- b) HRSB reserves the right to consider, during the evaluation of Tenders:
- i) Information provided in the Tender itself;
 - ii) Information received in response to enquiries of credit and industry references set out in the Tender;
 - iii) The manner in which the Bidder provides services to others;
 - iv) The experience and qualification of the Bidder;
 - v) The compliance of the Bidder to HRSB's requirements and specifications;
 - vi) Such alternate goods, services, terms or conditions that may be offered, whether such offer is contained in a Tender or otherwise,
 - vii) Splitting the Tender and Project Scope into multiple parts and accepting Tenders (or portions thereof) from more than one Bidder;
 - viii) Rejecting Bidder's recommendation of a Subcontractor or any other third party associated with the Tender and jointly along with the Bidder, determine alternate acceptable third parties; and
 - ix) Any other consideration in HRSB's discretion;
- c) HRSB may rely upon the criteria it deems relevant, even if such criteria has not been disclosed to Bidder. By submitting a Tender, the Bidder acknowledges the HRSB's rights under this Section and absolutely waives any right or cause of action against HRSB and its employees, agents or Trustees by reason of HRSB's failure to accept the Tender submitted by the Bidder, whether such right or cause of action arises in contract, tort including negligence or otherwise; and
- d) HRSB shall not at any time have any obligation to deal exclusively with the Bidder. HRSB expressly reserves its rights, in its sole discretion, to seek a Tender regarding the subject matter hereof, from any person whomsoever

and at any time.

(r) **Limitation of Liability**

Bidder, by submitting a bid to this Tender, agrees that it will not claim damages, costs or expenses for whatever reason, relating in any way to this Tender and any resulting process (including without limitation any subsequent discussions or negotiations, if any, or in respect of any competitive process) and waives any and all claims against HRSB whatsoever, whether for costs, damages or expenses incurred by Bidder in preparing its Tender, in participating in this tender process (including without limitation any subsequent discussion or negotiation, if any), loss of anticipated profit or any other matter whatsoever related to this tender and any resulting process, discussions or negotiations.

(s) **Construction Contract Guidelines**

The Halifax Regional School Board acknowledges and complies with the **Nova Scotia Transportation and Public Works Construction Contract Guidelines.**

1.3 **OTHER REQUIREMENTS**

- (a) The bidder must provide with the submitted tender document a certificate indicating the completion of the Nova Scotia Construction Safety Association's Construction Safety Program or other WCB approved safety audit company that jointly sign the Certificate of Recognition with the WCB.
- (b) The bidder must provide with the submitted tender document a letter showing they are in good standing with the Worker's Compensation Board.
- (c) The bidder must provide with the submitted tender document a tentative schedule indicating timelines for completion of works. **Upon award of work, the successful bidder shall provide within three (3) business days a schedule clearly indicating timelines for completion of all aspects of the project. Shop drawings/samples must be returned to HRSB for Consultant's review within five (5) days upon award.**
- (d) The bidder must provide with the submitted tender document, an insurance certificate showing **HRSB as "ADDITIONAL INSURED"** with proof of:
- (i) Commercial General Liability insurance, including but not limited to, products liability and completed operations, contractual liability, owners and contractors liability, attached machinery extensions, endorsement, independent contractor, for a combined single limit of no less than **\$5,000,000** per occurrence; Builder's Risk Insurance in the amount of the Contract Price.
 - (ii) Commercial Auto Liability insurance covering all owned, non-owned and hired vehicles for a minimum combined single limit of **\$2,000,000** per occurrence; and
 - (iii) It is also agreed that the above insurance coverage is primary.

Upon award, the bidder shall secure and maintain the insurance as noted above at its expense during the term of the contract.

The Halifax Regional School Board must be named as additional named insurance

pertaining to the work for this project. Furthermore, Halifax Regional School Board must receive at least thirty (30) days notice of cancellation or modification of the above insurance. Bidders shall at all times keep in force insurance as may be required.

(e) **BID SECURITY**

The bidder **MUST** provide with the submitted tender document **Bid Security** in the amount of **ten percent (10%) of the Contract Price** (before HST) in the form of a Certified Cheque, Irrevocable Standby Letter of Credit or Bid Bond payable to, or naming the Halifax Regional School Board.

BID BONDS *must be provided by a surety company licensed to issue surety bonds in the Province of Nova Scotia:*

- Provide bond on the standard CCDC Bid Bond Form, latest version, in the amount of not less than **ten percent (10%) of the Contract Price (before HST)**.
- Bid Bonds, submitted by the general contractor bidder, signed and sealed by the principal (Contractor) and Surety and shall be with an established Surety Company satisfactory to and approved by the Halifax Regional School Board.
- Where a Bid Bond is used as Bid Security, include the cost of providing the Bid Bond in the Tender Contract price.

Where **CERTIFIED CHEQUE or BANK DRAFT** is provided as bid security:

- Provide a certified cheque or bank draft, endorsed in the name of the Halifax Regional School Board, for a **sum not less than ten percent (10%) of the amount of the Contract Price (before HST)**.
- Where certified cheque or bank draft is used as Bid Security, include the cost in the Contract price.

Where the **IRREVOCABLE STANDBY LETTER OF CREDIT** is used as bid security:

- Provide an Irrevocable Standby Letter, endorsed in the name of the Halifax Regional School Board, for a sum not less than **ten percent (10%) of the Contract Price (before HST)**.
- The Irrevocable Standby Letter of Credit shall be issued by a certified financial institution subject to the Uniform Custom and Practices for Documentary Credit (1993 revision or latest revision) International Chamber of Commerce (Publication No. 500).
- Where Irrevocable Standby Letter of Credit is used as bid security, include the cost in the Tender Contract Price.

RETURN OF BID SECURITY:

- The bid security of the unsuccessful bidders will be returned to them after the contract has been signed, or previous to such time, at the discretion of the Halifax Regional School Board. The above shall apply provided a contract is awarded within sixty (60) days from the closing date of the bid. If no contract is awarded, all bid security will be returned.

(f) **CONTRACT SECURITY (ONLY REQUIRED FOR BIDS OVER \$100,000)**

For bids over \$100,000 bidders must provide **Contract Security by a surety company licensed to issue surety bonds in the Province of Nova Scotia** in the form of one of the following:

- Letter of Surety.
- Performance Bond and a Labour and Material Payment Bond OR
- Certified Cheque or Bank Draft OR Irrevocable Letter of Credit bearing the bidder's original signature, payable to or naming the Halifax Regional School Board as insured.

Bidder shall maintain performance assurance in force for a period of not less than twelve (12) months after the issue of the substantial performance certificate certified by Halifax Regional School Board and until completion of the contract.

Should it become apparent that the final cost of the project will **exceed the total amount payable by more than 10%**, the bidder shall arrange to have their bonds reissued based on the projected final cost.

Where a **LETTER OF SURETY** was used as **CONTRACT SECURITY**:

- Within ten (10) days after notification of award of the Contract, provide a Performance Bond and a Labour & Material Payment Bonds each in an amount **equal to fifty percent (50%) of the Contract Price (before HST)**, naming the Halifax Regional School Board.
- Performance Bond and Labour and Material Payment Bonds, submitted by the bidders, shall be provided at the expense of the bidder and shall be with an established Surety Company satisfactory to and approved by the Halifax Regional School Board.
- Include the cost of providing the Performance Bond and Labour and Material bond in the Contract price.

Where a **CERTIFIED CHEQUE OR BANK DRAFT** is used as **CONTRACT SECURITY**:

- The Certified Cheque or Bank Draft submitted during the bid period will be cashed and the amount retained by the Halifax Regional School Board shall serve as Performance Assurance, including the payment of all obligations arising under the Contract.
- The Certified Cheque or Bank Draft will be held in lieu of the Performance Bond and Labour and Material Bonds, providing that, at Contract award, the successful Bidder shall supplement their Certified Cheque or Bank Draft to maintain an amount of **twenty (20%) of the Contract price** (before HST) under the contract.
- The amount remaining will be returned without interest after a period of not less than twelve (12) months after the issue of the substantial performance certificate

certified by the Halifax Regional School Board and shall serve as performance assurance until completion of the contract.

- Where certified cheque or bank draft is used as Performance Assurance, include the cost of providing the certified cheque in the Contract price.

Where **an IRREVOCABLE STANDBY LETTER OF CREDIT** is used as **CONTRACT SECURITY**:

- The Irrevocable Standby Letter of Credit for a sum not less than **ten percent (10%) of the Contract price (before HST)** submitted during the bid period will be retained by the Halifax Regional School Board and shall serve as performance assurance, including the payment of all obligations arising under the contract. The irrevocable standby letter of credit shall be issued by a certified financial institution subject to the Uniform Customs and Practices for Documentary Credit (1993 revision) International Chamber of Commerce (Publication No. 500).
 - Where irrevocable standby letter of credit is used as Performance Assurance, include the cost of providing and Irrevocable Standby Letter of Credit in the Contract Price. The contractor shall provide to the Halifax Regional School Board documentation throughout the duration of the contract that the irrevocable standby letter of credit remains in full effect at all times as specified.
 - Upon expiry of the Irrevocable Standby Letter of Credit, a separate Irrevocable Standby Letter of Credit shall be provided for work requiring extended warranties for such amounts as are required by the contract.
- (g) The bidder must provide with the submitted tender document a completed copy of Appendix “E” Safety Plan information sheet. The contractor prior to commencement of work must have a safety plan in place for use by the contractor personnel regarding potential hazards and work practices specific to the site.
- (h) ***HRSB is directly responsible for the safety of its students and staff. Should contractors be required to work in or on school property while children are present, it is a MANDATORY HRSB REQUIREMENT that contractors assign the work to employees and/or sub-contractors who DO NOT have a CRIMINAL RECORD and who ARE NOT LISTED ON THE CHILD ABUSE REGISTRY. By checking the “Agreed” box at the bottom of clause 3.4 below you are confirming that you understand and will abide by this mandatory HRSB requirement. Failure to comply with this requirement may result in immediate contract termination.***
- (i) Contractors must submit warranty information with the tender bid submission and successful bidders must submit all appropriate warranty documents with final payment invoice.
- (j) Bidders are advised that, as per the Halifax Regional School Board Tobacco Free Schools and Workplace Policy, the HRSB endorses and supports implementation of the Nova Scotia Smoke Free Places Act 2002, which prohibits tobacco possession for persons under the age of 19 and declares that no person shall smoke in schools, school board

offices or on school grounds.

1.4 **AMENDMENTS OR WITHDRAWAL OF TENDER PRIOR TO BID CLOSING**

- (a) Tender may be amended or withdrawn **by post or facsimile (902) 464-0161** PRIOR to Tender Closing date and time.
- (b) Clearly indicate on the fax transmission or submitted envelope, whether your correspondence is an amendment or withdrawal and the title of the Tender. Sign and seal as required for tender, and submit at address listed under closing location on the cover of this document.

1.5 **THE CONTRACT**

1.5.1 Binding Effect of Proposal and Contract Finalization

The Bidder hereby acknowledges that its Tender constitutes a contract with HRSB, and the terms and conditions of this Tender and the bidder response (with the Tender taking precedence in the event of any inconsistency or conflict of terms) shall govern such agreement. Such contract shall remain binding upon Bidder until the earlier of:

- a) Written notice from HRSB that the Bidder's Tender is rejected as unsatisfactory; or
- b) Issuance by HRSB of its PO to the Bidder with respect to this Tender, pursuant to Section 1.2(p), and upon such issuance, the Bidder shall be regarded as the Contractor hereunder; or
- c) Execution of the Contract by both HRSB and the Bidder pursuant to Section 1.2(p); or
- d) Written notice from HRSB that it has entered a Contract with a Contractor and that the Bidder has been unsuccessful under this Tender.

1.5.2 Contract Documents

1.5.2.1 The attached form of contract (Schedule A) is a version that shall be issued to or executed by the successful bidder pursuant to the terms and conditions of this Tender. It is NOT TO BE executed and returned by the bidder as part of its (proposal or Tender response).

1.5.2.2 After the contract has been awarded and signed, the contractor will be contacted by the appropriate Regional Manager to attend a site visit to complete Appendix D of the contract – 'Undertaking to Comply and Contractors Safety Checklist' prior to the commencement of any work.

1.5.2.3 The Contract the Contractor will have with the HRSB, if awarded, will include:

- a) Such further documentation as may be negotiated and executed by the HRSB and the Contractor pursuant to Section 1.2(p); and

- b) This Tender and all of its Schedules, including without limitation any PO issued by HRSB to the Contractor, and any revisions, amendments or additional documents made thereto, if any; and
- c) The Tender, in its entirety and all promises made in the tender will be deemed covenants in the Contract and all information, representations and warranties made in the Tender will be deemed terms, representations and warranties of the Contract surviving the signing or issuance by HRSB of any additional or formal documents prepared by the HRSB.

1.5.2.4 For the purposes of evaluation and interpretation of Tenders, in the case of conflicts, discrepancies, errors or omissions between this Tender and any documentation issued or executed pursuant to Section 1.5.1, and the Tender, this Tender and such documentation shall take precedence over the Bidder response.

1.6 Your Contractual Terms

- 1.6.1 List separately any contractual terms which must be included as part of the Contract if awarded to you and which would be a condition to HRSB's acceptance of your bid.
- 1.6.2 List separately any contractual terms which you would like the HRSB to consider but which would not be a condition to the acceptance by the HRSB of your bid and which would only be part of the Contract with the HRSB with the specific further agreement of the HRSB.

2.0 SCOPE OF WORK

(a) Locations:

Astral Drive Elementary
Michael Wallace Elementary
Atlantic View Elementary

PACKAGE #1 – MOD BIT ROOF REPLACEMENTS as per drawings and specifications prepared by ARCHITECTURE 49.

- (b) School/Work site access control: **Contractor's employees shall always report to the main office of a school, indicate who they are and state their purpose on site prior to starting any work in the school.** Contractor is not permitted to work on the school site without HRSB assigned representative on site unless authorized by HRSB Manager of Operations.

The outside work area shall be appropriately demarked and/or surrounded by a barrier to prevent unauthorized entry to the work area. All workers shall contain their activity to the work site area. The contractor shall only use the school staff designated washroom and lunchroom facilities. Access to the school shall only be allowed as planned in coordination with HRSB Operations and the school administration.

The contractor and sub-contractor employees shall maintain professional and courteous behaviour, including work and communications practices, at all times on the project site. Communications and work shall be conducted so as to minimize the effect on regular school occupants and their activities.

- (c) Project/Safety Coordination: The contractor shall provide to HRSB within one week of award of contract a fixed schedule for all aspects of completion of work. The safety plan outline provided with this document must be posted on site during the execution of work and will be accessible to all workers on the site.

Where applicable, a **hot work permit** will be required to be completed prior to commencement of work and all conditions of the permit must be maintained until completion of hot work. A copy of the hot work permit signed by the contractor representative shall be provided to HRSB upon completion of each hot work session. Contractor must assign a designated fire watch as noted on the permit document who shall remain on site for three hours after completion of each hot work session.

The contractor will provide access to the work site and safety plan for inspection by HRSB Operations Services administration, HRSB health and safety Manager, consultants, regulatory inspectors as may occur throughout the duration of the project.

All necessary project coordination communications between project personnel and HRSB or site administration shall be from the project foreman/supervisor through the school principal and/or the Manager of Operations.

- (d) Hours of work - All work shall be carried out during **regular working hours** unless otherwise indicated in writing by the Manager of Operations Services or a designate. Hours of work shall comply with local ordinances and bylaws for each site.
- (e) Site Material Control: The contractor shall be responsible for storage of all materials required to complete the renovation. The school shall not be used for storage of materials unless otherwise approved by the principal and manager of Operations Services. Any requirement for modifications to the building in order to allow delivery and installation of the new equipment is the responsibility of the contractor.

The contractor is responsible for security of all project materials and access to the project site and/or the school through the project site at all times until completion of work and acceptance of the finished project by HRSB. Such additional security costs for security personnel or other means of security as deemed necessary by the contractor will be the sole responsibility of the contractor.

The contractor shall keep the work site free from accumulated debris caused by the employees or work and shall remove all debris at the end of each work shift. Debris shall not be deposited in HRSB controlled garbage and/or recycling containers.

All waste materials and debris created during demolition and/or construction shall be disposed of in a dumpster provided by the contractor, to be removed at the end of the construction project, using a methodology that is in compliance with the applicable HRM solid waste by laws. Otherwise, the material must be removed and disposed of off site at the end of each working day. The waste materials may not be stored on site unless they are held in an approved project dumpster.

All temporary structures such as portable washroom facilities, materials storage trailer, work trailer, debris dumpster, vehicles, etc., shall be located a minimum of (25) twenty-five feet from the school building.

- (f) 1 Contractor is advised that the building will be occupied when work on this project takes place. Contractor to verify all areas of construction are secured and air tight partitioned to ensure that the health and safety of the students and staff are maintained during the construction period.

2 Temporary Construction Utilities & Closures:

Contractor to erect and maintain ‘dust-tight’ barriers as noted. Prior to start-up, the ‘dust-tight’ separations must be in place as noted and reviewed by HRSB Project Manager and the Consultant. ‘Dust-tight’ enclosure will be reviewed during the course of construction. Contractor must maintain the current lighting levels, heating and ventilation standards in place.

3 Interior Closures and Construction Areas:

3.1 For interior/interior locations provide the following:

3.1.1 Gypsum board both sides to 9’-4”, AFF.

3.1.2 3 5/8 metal stud at 16” o.c., extend every 4th stud to underside of OWSJ.

- 3.1.3 Provide 10ml poly from top of gypsum board to u/s deck, sealed at the top of the wall to underside of deck.
- 3.1.4 Provide negative pressure within the construction space exhausted to the exterior.
- 3.2 Tarps are not to be used in lieu of the described closures.
- 3.3 Construction Access & Storage:
 - 3.3.1 Proper access to the area and storage of materials to be provided by the owner.
 - 3.3.2 Location to be determined by Project Manager on site.
- 3.4 Provide and maintain fire protection equipment during performance of the work as required by insurance companies, authorities having jurisdiction and governing codes, regulations and by-laws. Ensure no access is blocked for this purpose.
- 3.5 Contractor to coordinate a staging area for the Subcontractors for equipment, tools and material storage. Locate trailers and/or lockable waterproof sheds on site as per HRSB Project Manager's instructions.
- 3.6 Provide sanitary facilities in accordance with local authority having jurisdiction.

4 Indoor Environmental Protection:

- 4.1 There are several sources of potential contamination during a construction/renovation project. These include:
 - 4.1.1 Demolition Activities:
 - 4.1.1.1 Demolition activities release dust and fibrous materials into the air. Asbestos control is essential. Insulation in ceilings and walls, and ceiling tile all have a high fiber content that may produce substantial fibrous materials during demolition. Total suspended particulate levels may be very high with a significant portion of the total being of the respirable particle sizes.
- 4.2 Construction:
 - 4.2.1 Construction introduces additional dust and fibrous materials. Many construction materials used today emit a range of volatile organic compounds, especially formaldehyde. All glues, vapours, and gases rise from solvents used to prepare surfaces for bonding, and emissions from welding and soldering can introduce a range of metals into the air.
- 4.3 Finish Work and Materials:
 - 4.3.1 Final finishing and decorating of the renovated spaces can introduce strong odours and more VOCs. Solvents, paints and varnishes, and adhesives and other glues all add to the accumulation of these irritating compounds.
- 4.4 The Contractor shall ensure site clean up is carried out at the end of each working day. This includes partially used containers of solvents, paints, caulking, adhesives, and ensuring that these are removed from the site. All construction debris shall be removed from the site at the end of each day, either to an approved dumpster outside the building, or removed completely from the property.

5 Preparation:

- 5.1 Inspect perimeter partitions of the construction area, above the ceiling and seal all penetrations above and below the ceiling. Carefully remove the minimum number of ceiling tiles necessary to perform the inspection and the work of sealing the

partitions. HEPA vacuum above remaining ceiling tiles and grid and above existing ductwork to remove loose dust prior to removal.

- 5.2 Install new temporary 'dust tight' walls and include details of the plans for location.
- 5.3 Seal all doors leading to construction areas.
- 5.4 Any existing perimeter partitions of the construction area that do not extend to the underside of deck, Contractor to extend to ensure dust-free light area between the construction area and the remainder of the school.
- 5.5 Before any construction begins, doors between the rooms where work is being carried out and the adjacent corridor must be carefully sealed. Seal the doors completely at top, bottom, and sides. All vents, ducts, openings, etc. to be sealed. Do periodic inspections to ensure seals remain tight. Provide written information to the Project Manager.
- 5.6 Negative Pressure: Implement a system that extracts air directly from the work area, and discharges this air directly outside the work area to the outside of the building. All exhausted air is to pass through a HEPA filtering system before discharge to exterior. Place negative air pressure units in the area to be constructed in order to maintain a continuous negative pressure within the construction space. The construction area MUST be kept at a negative pressure relative to the occupied spaces.

6 During Construction:

- 6.1 Erect impermeable dust barriers to completely seal off the work area from adjacent areas.
- 6.2 Dust barriers are to be maintained and remain in place until work is completed and the facility representative has approved removal. Any damage to barriers must be repaired as soon as possible.
- 6.3 **Contractors will be held responsible for any damage, dirt or dust migration beyond the construction enclosure and all cleaning cost to rectify same will be borne by the General Contractor.**
- 6.4 Post signs on the doors indicating that there is to be absolutely no unauthorized entrance or exit through the sealed-off areas except for fire or security reasons. Ensure that the construction crew and others comply with these restrictions.
- 6.5 Clean the construction area daily.
- 6.6 Dirty or dusty footprints outside the construction area that have been left behind by people who were in the construction area are to be promptly cleaned.
- 6.7 Use water mist and commercial dust suppressing products, approved by the Owner, to control dust. Execute work by methods to minimize raising dust from construction operations.
- 6.8 In the event equipment or materials cannot be removed from the construction area, use drop sheets to cover these items.
- 6.9 Debris transported from the second floor will be by the exterior in all cases possible. Contractor to provide sealed chute to covered bins below.
- 6.10 Failure to provide adequate dust control will result in the contractor bearing the cost of any clean up, repair or replacement deemed necessary as a result of dust generated from the project.

- 6.11 Ensure that windows, doors, penetrations, electrical outlets and intake and exhaust vents are properly sealed with plastic and taped within work area.
- 6.12 For exterior work adjacent to windows in an existing facility, test window openings for air tightness and seal windows that leak.
- 6.13 Verify that all fresh air intakes facing construction operation are shut down, and sealed not to allow dust or debris intake.
- 6.14 Ventilation:
 - 6.14.1 Seal duct openings in work area until completed.
 - 6.14.2 Maintain negative pressure between work area and adjacent occupied areas by using portable ventilation equipment.
 - 6.14.3 Verify that air is exhausted directly outside and away from intake vents, or filtered through a HEPA filter before being recirculated. Where odour is a concern, ensure an approved air scrubbing material is utilized.
 - 6.14.4 The main building's air handling system shall be disconnected from use in areas of construction. This will require sealing of existing duct work on both the supply and return air systems.
- 6.15 Remedial Measures:
 - 6.15.1 Water leaks and flooding shall be reported immediately to the Project Manager.
 - 6.15.2 Detected water damage must be thoroughly investigated in consultation with the Project Manager. A plan of action will then be implemented as approved by the Project Manager.
 - 6.15.3 All investigations, removal and abatement procedures shall be conducted in a manner that does not promote dispersal of dust and spores.
- 6.16 Cleaning During Progress of Work:
 - 6.16.1 Clean work area with HEPA filter-equipped vacuums and wet mops, or both, at end of each work shift and as necessary.
 - 6.16.2 Ensure ventilation system is functioning properly and is cleaned if contaminated by soil or dust after work is complete.

7 After Construction:

- 7.1 Clean work area with HEPA filter equipped vacuums and wet mop.
- 7.2 Ensure air vents and ductwork are cleaned and seals removed.
- 7.3 If required, Contractor to conduct final indoor air quality test. Submit test results to the HRSB Project Manager.

8 Cutting and Patching

- 8.1 Provide openings larger than 8" in diameter in non-structural elements of Work for penetrations of structural, mechanical and electrical Work. Openings smaller than 8" diameter will be provided by the Sub-trades requiring same.
- 8.2 When floor cutting is required, Contractor to confirm there are no under-floor electrical or junction boxes. Contractor must utilize a electrically power operated floor saw.
- 8.3 Fit work airtight to pipes, sleeves, ducts, conduit, and after penetrations through surfaces.
- 8.4 At penetration of fire rated wall, ceiling, or floor construction, completely seal voids with approved fire-stopping and smoke sealing materials, full thickness of the construction element, as required to maintain the required fire resistance and smoke spread rating.

- 8.5 Refinish surfaces to match adjacent finishes: For continuous surfaces refinish to nearest intersection; for an assembly, refinish entire unit.
- 8.6 Conceal pipes, ducts and wiring in floor, wall and ceiling construction of finished areas except where indicated otherwise.

9 Progressive Cleanliness & Restoration of Damage

- 9.1 Maintain Work daily in tidy condition, free from accumulation of waste products and debris. Remove waste material and debris from site at end of each working day, and dispose of off-site. Ensure permits are obtained from authorities having jurisdiction for disposal of waste and debris.
- 9.2 Provide on-site containers for collection of waste materials and debris, and provide clearly marked separate bins for recycling.

10 Close Out Procedures:

- 10.1 Remove dust, stains, paint spots, soil grease, fingerprints and accumulations of construction materials, interior and exterior to the building. Perform cleaning in accordance with installer's instructions for each material. Final cleaning shall include:
 - 10.1.1 Washing exterior paved surfaces disturbed under this contract.
 - 10.1.2 Cleaning and polishing of glass and finish metals, interior of areas noted.
 - 10.1.3 Cleaning of hardware, mechanical fixtures, lighting fixtures, cover plates and equipment, including polishing of their finish metal, porcelain, vitreous and glass components.
 - 10.4.4 Removing of visible manufacturer's labels left on materials, components and equipment.
 - 10.5.5 Cleaning of new flooring and of all other flooring disturbed under this contract.

10.2 Maintenance materials:

- 10.2.1 Maintenance materials provided shall be new, not damaged or defective, and of the same quality and manufacture as products provided in the work. If requested, furnish evidence as to type, source and quality of products provided.
- 10.2.2 Provide 3% of all hard tile, floor and walls and 4 liters of each paint colour specified.

10.3 Testing Balancing and Adjusting

Provide testing and ensure agency is a current member of AABC certified to perform services.

10.4 Demonstration of systems and equipment

Provide complete demonstration of all systems and equipment in the presence of the Owner and maintenance representations at the following times:

10.5 Submittals

- 10.5.1 Provide with application for substantial completion certificate.
 - 10.5.1.1 Certificate of final inspection report from electrical utility or inspection.
 - 10.5.1.2 Other reports required or specified.
 - 10.5.1.3 Maintenance manuals and operating instructions.

10.5.2 Submit with application for release of final payment:

- 10.5.2.1 Final project record drawings including shop drawings.
- 10.5.2.2 Performance bonds which shall remain in effect for one year after takeover date.
- 10.5.2.3 Completed Liability Insurance Policy extended for one year over date.
- 10.5.2.4 Written guarantee covering all workmanship and materials used in the work.
- 10.5.2.5 Certificate from Worker's Compensation Board.
- 10.5.2.6 Maintenance Bonds as specified.
- 10.5.2.7 Maintenance Manual.
- 10.5.2.8 Spare parts and maintenance materials and list.
- 10.5.2.9 Extended warranties.

10.6 Substantial performance and final inspection procedures:

10.6.1 Provide:

An inspection of the work, identify deficiencies and defects; repair as required. Notify the consultants in writing and request Substantial Performance Final Inspection.

10.6.2 Present at the Substantial Performance Inspection will be:

10.6.2.1 The consultants and his sub-consultants that he requires and notifies.

10.6.2.2 The Owner and his consultants upon notification by the design builder.

10.6.2.3 The design builder and such sub-contractors that he considers are required.

10.6.3 The Contractor will compile a Substantial Performance deficiency list at this inspection and issue it to the Owner and his consultants.

10.6.4 Upon the Owner's completion of the deficiencies, the design builder shall submit an application for final payment and a certificate for payment will be issued by the consultant to the Board.

10.7 Substantial performance:

10.7.1 The owner will issue a Certificate of Substantial Performance when satisfied outstanding deficiencies noted during inspections prior to the Substantial Performance inspection have been corrected, and the work is substantially performed.

10.7.2 The owner reserves the right to occupy and use portions of the building(s), whether partially or entirely completed, or whether completed on schedule or not, provided such occupancy does not interfere with the Design Builders continuing work. Partial occupancy or installation by the Owner of his equipment shall not imply acceptance of Substantial Performance, in whole or in part, nor shall it imply acknowledgement that terms of the agreement are fulfilled.

10.7.3 The Certificate of Substantial Performance will be attached to the list of remaining deficiencies to be rectified before final acceptance.

10.7.4 Make submissions specified in this section.

10.8 Completion certificate:

- 10.8.1 The owner will issue a Certificate of Performance when he is satisfied that outstanding deficiencies noted during inspections have been corrected and the work is complete.
- 10.8.2 A list of remaining deficiencies to be rectified before final acceptance will be attached to the completion certificate.
- 10.8.3 Make submissions specified in this section.

10.9 Warranties:

- 10.9.1 Establishment of warranties:
 - 10.9.1.1 Warranties shall commence on date of approval of the Substantial Performance Certificate.
- 10.9.2 Warranty period:
 - 10.9.2.1 The Owner will notify the design builder of defects observed during warranty period and request him to remedy the defects in accordance with the contract documents.
 - 10.9.2.2 Thirty days before the expiration of warranties, the Owner and the design builder will inspect the work as arranged by the design builder noting defects of products and workmanship.
 - 10.9.2.3 The designer builder shall immediately remedy such noted defects.

2.1 **SITE VISITS**

- (a) Bidders will be deemed to have familiarized themselves with existing site and all other conditions which may affect performance of the Contract. No plea of ignorance of such conditions as a result of failure to make all necessary examinations and calculations will be accepted as a basis for any claims for extra compensation or an extension of time.
- (b) **A mandatory bidder's site meeting is scheduled as per the directions on the cover sheet of this document.**

3.0 **FORM OF TENDER - BIDDER DECLARES**

- (a) That this tender was made without collusion or fraud.
- (b) That the proposed work was carefully examined.
- (c) That the bidder is familiar with local conditions.
- (d) That contract documents and attachments were carefully examined.
- (e) That all the above were taken into consideration in preparation of this tender.

3.1 **BIDDER AGREES**

- (a) To enter into a contract to supply all labour, material and equipment and to do all work necessary to complete the Work as described and specified herein for the prices as per the Form of tender, Schedule of Prices, Article 3.5.
- (b) That this tender is valid for acceptance for 60 days from the time of tender Closing.
- (c) That failure to enter into a formal contract and give specified documents within time required will constitute grounds for forfeiture of this agreement.
- (d) That if Certified Cheque or bid bond is forfeited, the Owner will retain difference in money between amount of tender and amount for which owner legally contracts with another party to perform the work and will refund balance, if any, to bidder.
- (e) I/WE certify that the company listed herein is in good standing with the City of Halifax Tax Collector and all Municipal, Provincial and Federal Tax Agencies. Failure to complete this certification and maintain this status will be cause for rejection of your tender and/or cancellation of any contractual undertaking with the Board. We further agree with and accept the terms set out in this tender document.

Halifax Regional School Board

CONTRACTOR INFORMATION SHEET

***TENDER #3693
ROOF REPLACEMENT
PACKAGE #1***

FIRM _____

ADDRESS _____

E-MAIL ADDRESS _____

POSTAL CODE _____ PHONE _____ FAX _____

NAME OF PERSON SIGNING FOR FIRM _____

POSITION OF PERSON SIGNING FOR FIRM _____

The undersigned company represents and warrants that it is authorized to carry on business of this nature and that it is not prohibited by any law applicable in Nova Scotia from performing this Contract. The undersigned also acknowledges receipt and understanding of, and has taken into consideration all information presented in, this tender and agrees to be bound by its terms and conditions. The undersigned further confirms and agrees that the person whose name is set out below is fully authorized to represent the company and to bind it to this bid and the Contract awarded pursuant to it and in all matters relating to or arising out of the subject matter of this tender.

I/WE, the undersigned, having carefully examined the ***#3693 MOD BIT ROOF REPLACEMENTS – PACKAGE #1*** tender documents, and having read, understood, and accepted the Conditions of the tender which form part of the tender documents, hereby offer to provide the materials and service in strict accordance with the ***#3693 MOD BIT ROOF REPLACEMENTS –PACKAGE #1*** documents, which form part of this tender.

I/WE, hereby agree that notification of acceptance of this bid shall be in writing and may be sent by prepaid post or fax, and if sent by prepaid post, acceptance shall be deemed to have been made on the date of mailing of such notification.

3.2 **REFERENCES:**

The Bidder shall furnish particulars of at least three contracts successfully completed or currently being carried to completion. The projects quoted should preferably be approximate in nature to the Works now proposed for and be of comparable or greater size.

Contact Name & Phone #	Date	Contract Value
_____	from _____ to _____	_____
_____	from _____ to _____	_____
_____	from _____ to _____	_____
_____	from _____ to _____	_____

3.3 **SUB CONTRACTORS:**

The Bidder shall enter the name and address of each Sub-Contractor used in making up this Tender. Only one Sub-Contractor shall be named for each part of the work to be sublet.

Subcontractor/Suppliers/Manufacturers	Service/Material

3.5 **SCHEDULE OF PRICES**

CONTINGENT UNIT PRICES: [see article 1.2 (p)]

Provide unit prices for contingency items in the event that additional work items are required in association with the scope of work as outlined in section 2.0 and the total value of unit prices shall be included in the Total Fixed Cost price.

Item No.	Description	Unit of Measurement	Estimated Quantity	Unit Price
1.	_____	_____	_____	\$ _____
2.	_____	_____	_____	\$ _____
3.	_____	_____	_____	\$ _____
4.	_____	_____	_____	\$ _____
5.	_____	_____	_____	\$ _____
6.	_____	_____	_____	\$ _____

3.6 **TIME AND MATERIAL PRICES:**

Provide unit prices for time and material work if no fixed price is requested in association with the work as outlined herein.

Item No.	Description	Unit of Measurement	Estimated Quantity	Unit Price
1.	_____	_____	_____	\$ _____
2.	_____	_____	_____	\$ _____
3.	_____	_____	_____	\$ _____
4.	_____	_____	_____	\$ _____
5.	_____	_____	_____	\$ _____
6.	_____	_____	_____	\$ _____

3.7 **PROPOSED FIXED PRICE**

The fixed price shall be the full inclusive value of the work. The prices submitted shall be all-inclusive and shall include for all the general and special requirements to meet the specifications of the work, including any contingent costs.

<u>Description</u>	<u>Total Fixed Price</u>
<i>ASTRAL DRIVE ELEMENTARY</i>	\$ _____
<i>MICHAEL WALLACE ELEMENTARY</i>	\$ _____
<i>ATLANTIC VIEW ELEMENTARY</i>	\$ _____
<i>SUBTOTAL FOR ALL SCHOOLS</i>	\$ <u>_____</u>
<i>HST (15% OF TOTAL PRICE)</i>	\$ _____
<i>TOTAL CONTRACT PRICE</i>	\$ <u>_____</u>

SUBSTANTIAL PERFORMANCE DATE: _____

BIDDERS HST REGISTRATION NO. _____

3.8 **SIGNATURE:**

SIGNED AND DELIVERED
in the presence of:

CONTRACTOR

Company name

Witness

Signature of Signing Officer

Name and Title (printed)

SCHEDULE A

AGREEMENT FOR SUPPLY OF SERVICES

This Agreement made effective on the _____ day of _____ in the year 20

For:

Project Name:

Location:

Tender #

by and between:

HALIFAX REGIONAL SCHOOL BOARD ("HRSB")

and

COMPANY NAME:

ADDRESS:

CITY:

PROV:

Postal Code:

The parties agree as follows:

- (the "Contractor")
1. Contractor shall provide to HRSB the services set forth in Appendix "C" – Description of Services, and accompanying Exhibits (which along with all other obligations of Contractor set forth in this Agreement shall constitute the "Services") in accordance with the terms of this Agreement.
 2. This Agreement consists of the following parts (together, the "Agreement"), each of which shall be construed as an integral part of this Agreement:

This signature page

Appendix "A" – General Terms and Conditions

Appendix "B" – Risk Management & Safety

**Appendix "C" – Description of Services
Exhibit A – RFP or Invitation to Tender**

Exhibit B – Response to RFP or Tender

**Appendix "D" – Undertaking to Comply Form and Contractor Safety
Checklist**

Appendix "E" – Safety Plan

Appendix "F" – Contractor Checklist

The above Appendixes and Exhibits are intended to be complementary, and what is required by any one shall be as binding as if required by all.

3. Contractor confirms that it has read this Agreement before signing it.

4. The individual signing below for Contractor warrants by his/her signature hereon that he/she has authority to bind Contractor to this Agreement.

HALIFAX REGIONAL SCHOOL BOARD

CONTRACTOR

Signature: _____

Signature: _____

Name (print): Kathryn Burlton

Name (print): _____

Title (print): *Purchasing Manager*

Title (print): _____

Date: _____

Date: _____

SAMPLE ONLY

CONTRACTOR'S ATTENTION IS SPECIFICALLY DRAWN TO THE APPENDIX "A" TERMS AND CONDITIONS GOVERNING THIS AGREEMENT. EXECUTING PARTIES' ATTENTION IS DRAWN TO APPENDIX "C" AND APPENDIX "C" TO BE INITIALED OR EXECUTED BY EACH PARTY IN ACKNOWLEDGMENT OF THE TERMS THEREIN.

APPENDIX "A"

TERMS AND CONDITIONS

SERVICES

Services: Contractor shall provide the Services to HRSB in accordance with the terms of this Agreement, on the HRSB properties specified in Appendix "C" (the "**Description of Services**"). Except as may be otherwise expressly provided in Appendix "C", Contractor shall provide all the equipment, personnel, supplies, consumables, supervision and labour necessary to complete the Services in a good and workmanlike manner. No changes or modifications to the Services or otherwise to this Agreement shall be valid unless made in accordance with Article 5 of this Agreement. The Contractor shall employ a competent supervisor who shall be in attendance at the place of work at all times while Services are being performed.

Term: This Agreement shall commence upon and later expire upon the dates specified in Appendix "C" (such period being the "**Term**"), unless earlier terminated in accordance with the provisions of this Agreement. Should Contractor continue to provide, and HRSB continue to pay, for the Services beyond the Term, such provision of Services shall be deemed to be on a temporary basis only and terminable at any time by HRSB with or without cause, and the provisions of this Agreement shall apply in full force (save as to the termination provisions in Article 9) until such termination.

FINANCIAL TERMS, PAYMENT, LIENS

Contract Price: For and in consideration of the Contractor providing the Services in accordance with the terms of this Agreement, the HRSB agrees to pay to the Contractor the sum of

§

(*plus HST*) hereinafter referred to as the "**Contract Price**". Such Contract Price shall include any and all expenses Contractor may incur in the performance of the Services.

Invoices: The Contractor shall submit a single invoice to HRSB for all Services rendered under this Agreement unless Appendix "C" provides otherwise. Contractor's invoice shall indicate applicable sales and use taxes as separate amounts and indicate the net taxable value including all applicable discounts. HRSB shall not be obligated to pay any taxes to Contractor unless Contractor is registered with the applicable authorities and provides its registration number on the invoice. Contractor's invoice shall be in a form acceptable to HRSB and contain sufficient details to ascertain the scope of Services performed and, if requested, Contractor shall provide documentation in support of an invoice. If HRSB disputes any portion of the invoice, it shall pay such invoice less the disputed amount, subject to adjustment upon resolution of the dispute. Non-payment by HRSB of any amount in dispute shall not alleviate, diminish or modify in any respect Contractor's obligations to perform as required by and in accordance with this Agreement.

Payment of Invoices: Upon the HRSB certifying that the Services have been completed, the HRSB shall pay to the Contractor, thirty (30) calendar days from the date of such certification,

unless otherwise stipulated in Appendix "C", the full Contract Price due and payable hereunder, less any holdback required to be retained under the *Builder's Lien Act* of Nova Scotia (the "*Builder's Lien Act*"), other statutory obligation or as otherwise stipulated in Appendix "C", provided the Contractor has submitted the following:

a written statement from the supplier(s) of all materials used for the Services certifying that payment has been made in full for same or waivers of liens from such supplier(s) in due form;

a worker's wage statement containing all the information required by the HRSB pertaining to the Contractor's, and all of its subcontractors', workers. Such statement requires the name of the workers, hours worked, rate of pay, total wages received, and a signature from each worker certifying that they have received payment in full for all time worked on the job indicated on the form; and

certification that the statement is correct.

Release of Holdbacks: No holdback shall be paid to the Contractor until the Contractor has provided to the HRSB a statutory declaration in a form as set forth in Canadian Construction Documents Committee ("CCDC") Document 9A, together with evidence of compliance with the *Workers' Compensation Act*, and, if applicable, a copy of the Certificate of Title for the Lands, dated thirty (30) calendar days from the issuance of the Certificate of Substantial Performance (as defined in the *Builder's Lien Act*) of work by the Contractor, confirming that no liens have been placed against the Lands in association with Contractor's Services.

Liens: Contractor shall keep the Lands and all HRSB property free from any and all laborers', materialmen's and mechanics' liens and similar claims and encumbrances. To the fullest extent permitted by law, Contractor waives all rights to assert such liens against the Lands and all HRSB property. If Contractor fails to release and discharge any claim of lien of others against the Lands and HRSB property within FOUR (4) business days of receiving notice from HRSB, HRSB may at its option discharge or release the claim of lien, or otherwise deal with the lien claimant, and Contractor shall be liable to and shall pay HRSB any and all costs and expenses of HRSB in doing so, including all reasonable legal fees and expenses. Notwithstanding the foregoing, for the purpose of enforcing the terms of this Agreement, HRSB may apply for the following liens and rights when circumstances deem it necessary:

if the Contractor contracts for one or more jobs with HRSB, the HRSB shall have a lien on the Contract Price and extras on that job as well as on their other jobs with the HRSB;

the HRSB shall have a lien on the Contractor's equipment or supplies on any job; and

in the case of Contractor, without sufficient cause (in the opinion of the HRSB), suspending work on any job which continues for more than two (2) days, HRSB may take possession of any materials delivered to or for the Contractor on such job and use same, giving the Contractor credit for its value at not more than cost thereof to the Contractor, against any liability of the Contractor to the HRSB and may use any of the Contractor's equipment that was in use on any of the HRSB's premises until the completion of the unfinished work.

Tax: Contractor shall comply with all applicable tax laws, including but not limited to laws relating to: (i) the collection and remittance of HST; and (ii) the withholding of applicable taxes from those of its employees performing work under this Agreement. Contractor shall be liable for and shall indemnify HRSB in respect of any claims, penalties, interest or costs made or assessed against HRSB arising from Contractor's non-compliance with tax laws.

Audit: Contractor shall keep and maintain true and correct books, records and accounts with respect to the Services and any materials supplied in relation to the Services, along with invoices and monthly summaries, for a period of seven (7) years after Contractor ceases to provide the Services. Contractor shall, upon request of HRSB, make available and permit HRSB during such period to inspect, make copies of, and audit all such records. If there is any revision to charges as a result of an audit, within thirty (30) days of the audit Contractor shall pay to HRSB the full amount of any credit or HRSB shall pay to Contractor the full amount of any shortfall, as the case may be. The provisions of this Section shall survive the termination of this Agreement.

DUTIES OF THE CONTRACTOR

Sub-Contractors: Contractor shall not subcontract the whole or any part of the Services without first receiving the written consent of HRSB, which consent may be withheld in HRSB's sole discretion. Where such consent is granted, Contractor shall not be released or relieved from any obligations or liabilities of Contractor under this Agreement nor shall HRSB be prevented from pursuing any legal or equitable remedies it may be entitled to against Contractor. Contractor shall remain liable and responsible to HRSB for the actions and omissions of any subcontractor and shall ensure that any subcontractor strictly adheres to all terms of this Agreement, including any safety requirements referred to in this Agreement. When requested by HRSB, Contractor shall provide HRSB with all details concerning any and all subcontracted work.

Site Representative and Instructions: The Contractor shall identify in the Undertaking to Comply attached in Appendix "D" to this Agreement, a job site representative to act on the Contractor's behalf. This representative shall have the authority to represent the Contractor with relation to taking instruction on behalf of Contractor and entering agreements or taking such other actions on matters related to this Agreement. HRSB shall identify in Appendix "C" Description of Services, or through subsequent notice to Contractor, its project manager, who has the authority to represent HRSB and instruct Contractor on matters related to this Agreement. If the Contractor representative is not on the job site at the time of a visit by HRSB's project manager, the orders of the HRSB project manager to any worker present shall be carried out. Contractor shall not seek direction from any person on matters related to this Agreement, other than from the HRSB project manager.

DELAYS

Delays: If the Contractor is delayed in the performance of the Services, and such delay is outside the Contractor's direct control, then the schedule to perform the Services may be extended for such reasonable time as the HRSB may decide in consultation with the Contractor. No such extension shall operate to extend the Term of this Agreement. Weather is not considered a reason for delay. No extension shall be made for delay unless written notice of

delay is given to the HRSB not later than two (2) working days after the commencement of delay, providing however, that in the case of a continuing cause of delay only one notice of claim shall be necessary, and for only such period as approved by HRSB in writing, in its discretion.

Delay by HRSB: The HRSB will not, except by written notice to the Contractor, stop or delay the Services as a result of pending instructions or proposed changes in the Services.

Adherence to Schedule: If the Contractor is delayed in the performance of the Services by any cause within the Contractor's control, the Contractor shall at no cost to the HRSB take effective action to restore the Services to the original time schedule for their completion, whether or not such schedule is appended to this Agreement.

CHANGES IN THE WORK

Change Orders: The HRSB, without invalidating this Agreement, may make changes in the Services with the Contract Price and Term being adjusted accordingly, by written notice of change (a "Change Order"). No changes in the Services shall proceed without a Change Order signed by the HRSB and no claim for a change in the Contract Price or change in the Term shall be valid unless so ordered and at the same time valued by the Contractor as provided in Section 5.2.

Change Approvals: When a change in the Services is proposed or required, the Contractor shall present to the HRSB for its approval the value of the change whether an extra charge or a credit. Changes submitted for approval are to be accompanied by a detailed breakdown of labour and materials, to which shall be added supervision, overhead and profit charges. Change charges submitted shall be calculated in the following manner:

for work done by the Contractor, add to the net direct cost not more than ten (10%) percent for overhead, profit, supervision and bonding costs; and

for work done by any subcontractor, add to the net direct cost, not more than FIVE (5%) percent for overhead and profit payable to the subcontractor, and add not more than FIVE (5%) percent to the subcontractor's amount for supervision of the subcontractor by the Contractor and for bonding costs.

The HRSB will satisfy itself as to the correctness of such claim and, when approved by the HRSB, a Change Order shall be issued to the Contractor amending the Contract Price and Term as appropriate.

DEFECTIVE WORK & DISMISSAL OF WORKERS

Defective Work: Defective work is work that has been rejected by the HRSB as failing to conform to this Agreement. Contractor shall promptly correct defective work, as required to conform to this Agreement, with no change in Contract Price. If, in the HRSB's opinion, it is not expedient to correct defective work, the HRSB may deduct from the Contract Price the difference in value between the Services as performed and that required by this Agreement, the amount of which will be reasonably determined by the HRSB.

Dismissal of Workers: The Contractor shall, on the request of the HRSB, immediately dismiss from the job any person employed by the Contractor who may, in the opinion of the HRSB, be incompetent or for misconduct, and such persons shall not again be employed on the job without the prior written permission of the HRSB. Foul language will be considered as misconduct.

PRODUCT OPTIONS AND SUBSTITUTIONS

Product Selection: Contractor may:

for any products specified by non-proprietary specification in Appendix "C", select any product of any manufacturer which meets the requirements of this Agreement.

for products specified by proprietary specification and accompanied by words indicating that substitutions will not be accepted in Appendix "C", select any product or manufacturer named. Substitutions are not permitted; and

except where substitutions are not permitted, when a product is specified by proprietary specification, other unnamed products will be accepted, subject to such substitutions being the same generic type, and capable of performing the same functions and meeting or exceeding the standards of quality and performance, as the named product. Substitutions shall not require revisions to this Agreement or a Change Order.

Product Substitutions: When making a substitution, the Contractor shall represent in writing that:

Contractor has investigated substitute products and/or manufacturer and has determined that the substituted product meets the criteria specified in Section 7.1 (c);

Contractor will make any changes to the Services necessitated by the substitution as required for the Services to be complete in all respects; and

Contractor waives all claims for additional costs and time caused by substitution, which may subsequently become apparent.

COMPLIANCE WITH LAWS, SAFETY AND PRIME CONTRACTOR

Compliance with Laws: Contractor shall comply with, and shall ensure subcontractors comply with, all applicable federal, provincial, and municipal laws, regulations and by-laws and to all other applicable orders, rules and regulations of any authority having jurisdiction respecting the Services, including without restriction all applicable environmental legislation, employment standards codes and workers' compensation legislation or equivalent legislation. CONTRACTOR SHALL FURNISH HRSB WITH WRITTEN CONFIRMATION FROM THE APPLICABLE WORKERS' COMPENSATION AUTHORITIES, OR EQUIVALENT AUTHORITIES, THAT CONTRACTOR AND ANY SUBCONTRACTORS ARE IN GOOD STANDING WITH SUCH AUTHORITIES, AND NO CONTRACTOR INVOICE SHALL BE PAYABLE UNTIL SUCH CONFIRMATION IS RECEIVED.

Safety: Contractor shall comply with and shall ensure all of its agents, employees and subcontractors comply with all applicable fire, safety, health, and environmental laws and regulations, including all safety, health and environmental requirements pursuant to any government permit, license, or authorization. Contractor shall be solely responsible for ensuring the safety and health of its agents, employees and subcontractors and for ensuring that its activities do not compromise the safety of HRSB's operations.

Occupational Health and Safety Legislation: Contractor shall comply with all applicable provisions of the *Occupational Health and Safety Act* (Nova Scotia) (the "Act") regulations thereto. Contractor shall execute and provide to HRSB the Undertaking to Comply Form with attached Pre-Construction Meeting Contractor Safety Checklist attached as Appendix "D". Contractor shall also supply to HRSB a Certificate of Recognition (COR) form as required under the Act and other applicable legislation.

Designation of Prime Contractor: The parties agree to designate in Appendix "D" that the Contractor shall be the "prime contractor" for the work site on the Lands for the purposes of the Act, during the Term, under this Agreement. The Contractor hereby agrees that:

such obligation shall extend to protect all contractors, employees, workers and persons as specified in the Act concerning the work site notwithstanding that they have been retained by HRSB after the date of execution of Appendix "D" by the Contractor; and

HRSB may in its sole discretion notify the Contractor in writing that the Contractor shall, following the date of such notice, assume the role of the "prime contractor" under the Act with respect to the work site notwithstanding that the Contractor was not so designated in Appendix "D" at the time of its execution by the Contractor, and the Contractor hereby agrees to do so.

Responsibilities of the Prime Contractor: Contractor shall:

direct all subcontractors, other contractors, employers, workers and any other personnel at the work site on safety related matters, to the extent required to fulfill its "prime contractor" responsibilities pursuant to the Act, regardless of:

whether or not any contractual relationship exists between the Contractor and any of these entities, or

whether or not such entities have been specifically identified in this Agreement;

ensure all obligations under the Act are strictly adhered to by all personnel;

be diligent in ensuring that its subcontracts comply with all health, safety and environmental legislation;

take appropriate disciplinary action against subcontractors who contravene health, safety or environmental legislation, which includes but is not limited to the suspending of the work performed by the subcontractors, before allowing them to continue to work on the site; and

ensure that Contractor or subcontractors never place the HRSB students, staff, volunteers or the general public at risk of injury or illness related to work conducted under this Agreement.

The HRSB shall provide Contractor, where applicable, with a list of all subcontractors under contract to the HRSB, working on the work site at the same time as Contractor, as well as their contact information. Failure by the HRSB to provide such information to Contractor shall not relieve Contractor of its obligation under this Section 8.5.

HRSB Access: At all times during the Term, HRSB Project Managers, agents and designates shall have the right to access, ingress and egress any work site, building or facility where Contractor performs the Services, and any part thereof, for any purpose, and neither Contractor nor its subcontractors shall refuse such access, ingress or egress whatsoever.

TERMINATION

Insolvency: If the Contractor should be adjudged bankrupt, or makes a general assignment for the benefit of creditors because of insolvency or if a receiver is appointed, the HRSB may, without prejudice to any other right or remedy it may have, by giving the Contractor or receiver or trustee in bankruptcy written notice, immediately terminate this Agreement.

Breach by Contractor: If the Contractor should neglect to prosecute the Services properly or otherwise fail to comply with the requirements of this Agreement, the HRSB may notify the Contractor in writing that it is in default of its obligations and instruct it to correct such default within FOUR (4) business days immediately following the receipt of such notice. If the correction of the default cannot be completed in the FOUR (4) business days specified, the Contractor will be considered to be actually attempting to cure the default if it:

commences the correction of the default on a best efforts basis, in HRSB's sole opinion, within FOUR (4) business days of receiving a notice of default;

provides the HRSB with a schedule for such correction which HRSB approves by written notice to Contractor; and

completes the correction in accordance with such approved schedule and without any additional cost or delay to the HRSB.

If the Contractor fails to correct the default in the time specified or subsequently agreed upon, the HRSB, without prejudice to any other right or remedy it may have, may terminate the Contractor's right to continue with the Services in whole or in part, and/or terminate this Agreement. Such termination must be in writing to the Contractor upon thirty (30) days notice.

Other Remedies: If this Agreement is terminated in whole or in part by the HRSB as a result of the default of the Contractor, the HRSB shall be immediately entitled to withhold any and all further payments which may be due and owing to the Contractor, complete or hire a third party to complete the Services in a manner it determines to be expedient, or to do whatever else it deems prudent or expedient in the circumstances to complete the Services.

Safety Default: This Agreement may be immediately terminated by HRSB for non-compliance by Contractor of any of its obligations under Article 8 of this Agreement.

DISPUTE RESOLUTION

Disputes Generally: Disputes between the Contractor and the HRSB as to the interpretation, application or administration of this Agreement or any failure to agree where agreement between the parties is called for, which are to be resolved between the parties, shall be settled by mediation and/or by arbitration.

Use of Mediation. Should HRSB choose to mediate a dispute:

Mediation shall take place on a confidential, without prejudice, basis with a single trained mediator who is a member of the Nova Scotia Arbitration and Mediation Society, jointly selected by the Contractor and the HRSB (the “**Mediator**”). The Mediator must be impartial and independent with no involvement in the dispute. This impartiality must be assessed by each of the parties prior to mediation. If a bias or perception of bias develops during the mediation, either party or the Mediator may terminate the mediation.

The Contractor, the HRSB and the Mediator shall agree on the fees, timing and any specific procedures and shall share the costs of mediation equally. All parties shall agree to and sign an agreement to mediate drawn up by the Mediator prior to mediation.

10.3 Arbitration: By written notice by one party to the other (a "Notice of Arbitration"), all disputes arising out of this Agreement, including its interpretation, must be submitted to binding arbitration in accordance with the provisions of the *Commercial Arbitration Act* (Nova Scotia), subject to the following:

- (a) The arbitration panel will consist of one arbitrator. If the parties fail to reach agreement on the selection of the arbitrator within 10 days following delivery of the Notice of Arbitration, any party may apply to The Supreme Court of Nova Scotia to appoint the arbitrator. The arbitrator will be qualified by education, training and industry experience to rule upon the particular dispute to be resolved.
- (b) The arbitrator will be instructed that time is of the essence in the arbitration proceeding and, in any event, the arbitration award must be made within 90 days of the submission of the dispute to arbitration and within 15 days of the conclusion of any hearing, or if there is no hearing, within 15 days of the delivery of written submissions.
- (c) The arbitration will take place in Halifax, Nova Scotia or such place as the parties may agree and will be conducted in the English language.
- (d) The arbitration award will be given in writing and will be final and binding on the parties. The award will give reasons and will deal with the question of costs of the arbitration and all related matters. The contractor and the HRSB shall share the costs of arbitration equally, unless otherwise determined by the Arbitrator.
- (e) The parties will keep all matters relating to the arbitration strictly confidential. The existence of the proceeding and any element of it (including any pleadings, briefs or other documents submitted or exchanged, any testimony or other oral submission in any award) will not be disclosed except to the arbitrator, the parties, their counsel and any person necessary to the conduct of the proceeding, except as may be required by law or as may be lawfully required in judicial proceedings relating to the arbitration.

PERFORMANCE BOND

Bond Requirement: Contractor shall, on execution of this Agreement, provide and pay for a performance bond in the amount of fifty (50%) percent of the Contract Price and a labour and materials payment bond in the amount of fifty (50%) percent of the Contract Price issued by a bond company acceptable to the HRSB, to continue in force for one (1) year after substantial completion of the Services, covering the performance of all obligations of the Contractor and all warranties of the Contractor under this Agreement. *Required* *Not Required*

WARRANTY

Warranty: The Contractor hereby warrants that:

it shall correct promptly, at Contractor's sole expense, defects or deficiencies in the Services as a result of workmanship or materials, which appear prior to the first (1st) anniversary of the date of completion of the Services, or such longer periods as may be specified for certain products or work in Appendix "C"; and

during the construction and warranty periods, defects or deficiencies in the Services, causing an emergency condition on the Lands or premises requiring immediate remedial/emergency repairs, outside of normal working hours, will be responded to by the HRSB's operations or maintenance staff. Costs for this emergency response will be the responsibility of the Contractor, and Contractor is hereby liable to indemnify HRSB for all such costs.

CONFIDENTIALITY AND OWNERSHIP OF WORK PRODUCT

Confidentiality: Contractor shall:

not make use of any HRSB Confidential Information for its own personal gain or for any purpose other than is required to provide the Services;

not disclose any HRSB Confidential Information to any person except employees, consultants, subcontractors and agents who have a need to know such information consistent with the provision of the Services, but only after such person has properly assumed obligations identical in principle to those in this Section and Contractor ensures that such person at all times complies with those obligations

employ diligent efforts and exercise reasonable care to hold all HRSB Confidential Information in the strictest confidence;

not use HRSB's name for any marketing or promotional purposes and not make any public announcements or disclosure in respect of this Agreement or Contractor's relationship with HRSB without first obtaining written consent from HRSB; and

be liable to HRSB and indemnify HRSB for any breach of this Section by Contractor or its employees, consultants, subcontractors or agents.

Terms of Agreements: Neither party shall disclose the terms of this Agreement or amounts paid under it to any person without the other party's written consent, except to a party's employees, professional advisors and insurers who have a need to know such information, but only where the party ensures that such persons are under obligations of confidentiality identical in principle to those in this Section. HRSB shall not disclose Contractor's information respecting pricing or any information supplied by Contractor that is clearly marked "Confidential" to any person except HRSB's employees, consultants, subcontractors and agents who have a need to know such information.

"HRSB Confidential Information" refers to any and all information, material and data disclosed to Contractor by HRSB, or obtained by Contractor in connection with providing the Services, directly or indirectly, orally, in any written form, or in any magnetically or electronically recorded form, or by drawings or inspection of parts or equipment, and including but not limited to: (i) information, knowledge or data of an intellectual, technical, scientific, commercial or industrial nature, or of a financial, cost, pricing, or marketing nature relating to the business operations of HRSB; or (ii) any information supplied by HRSB that is clearly marked "Confidential"; but shall not include information in the public domain or information that at the time of disclosure was already known to Contractor on a non-confidential basis.

Ownership of Work Product: All property and intellectual property rights in all reports, designs, drawings, studies, specifications, software, materials, inventions and other work product created, produced or arising in connection with the performance of the Services, whether completed or in progress, and regardless of who was involved therewith, shall be owned exclusively by HRSB and either delivered to HRSB or made available for inspection by HRSB. HRSB's ownership of and title to the foregoing shall arise automatically upon its creation and not be subject to the payment of the Contract Price to Contractor. To the extent Contractor has any title to the foregoing, Contractor shall take and cause to be taken all necessary steps (including a waiver of any moral rights) to transfer title thereto to HRSB.

Survival: The provisions of this Article shall survive the expiration or termination of this Agreement.

MISCELLANEOUS PROVISIONS

Notices: Communications in writing between the parties shall be considered to have been received by the addressee on the date of delivery if delivered by hand or by facsimile, or if sent by post, to have been delivered within FOUR (4) business days of the date of mailing, when addressed to the addresses in Appendix "C":

Assignment: This Agreement is not assignable by Contractor without the prior written consent of HRSB, which consent may be withheld arbitrarily. Any purported assignment by Contractor of any of its rights, duties, or obligations under this Agreement without HRSB's written consent, shall be voidable by HRSB at its option. Contractor shall not in any event be released from its duties and obligations under this Agreement. HRSB may assign this Agreement upon providing notice to without obtaining Contractor's consent.

Binding Effect: This Agreement shall be binding upon and enure to the benefit of each of HRSB and Contractor and their respective successors and permitted assigns.

Interpretation: In this Agreement, all references to 'dollars' or '\$' are to Canadian dollars unless stated otherwise. The insertion of headings is solely for convenience of reference and shall not affect the interpretation of any provision.

Independent Contractor: The parties agree that Contractor is an independent contractor, that nothing in this Agreement shall be construed as establishing or implying a relationship of master and servant between the parties, or any joint venture or partnership between the parties, and that nothing in this Agreement shall be deemed to constitute either of the parties as the agent of the other party or authorize either party to incur any expenses on behalf of the other party or to commit the other party in any way whatsoever. Contractor and its servants, agents or employees shall at no time be deemed to be servants, agents or employees of HRSB, or be deemed to be under the control or supervision of HRSB when carrying out the Services. Without the prior written consent of HRSB.

No waiver: No party shall be deemed to have waived the exercise of any right that it holds under this Agreement unless such waiver is made in writing. No waiver made with respect to any instance involving the exercise of any such right shall be deemed to be a waiver with respect to any other instance involving the exercise of that right or with respect to any other right.

Governing Law: This Agreement shall be governed by and interpreted in accordance with the laws of the Province of Nova Scotia and the laws of Canada applicable therein, excluding any conflict of laws rules that may apply therein. The parties hereby attorn to the non-exclusive jurisdiction of the courts of the Province of Nova Scotia, without prejudice to the rights of HRSB to take proceedings in any other jurisdiction. The parties hereby waive any right to a trial by jury.

Time of the Essence: Time shall be of the essence in this Agreement.

Set-Off: HRSB shall be entitled at all times to set off any amount owing from Contractor to HRSB against any amount due or owing to Contractor with respect to this Agreement.

Entire Agreement; Invoice Terms of No Effect: This Agreement constitutes the entire agreement of the parties concerning its subject matter and no other representation, warranties or agreements, either oral or written, shall be binding upon HRSB or Contractor. This Agreement supercedes and invalidates all prior agreements, understandings, negotiations, representations and warranties, whether oral or written, with respect thereto. The terms of this Agreement shall supersede any terms attached to Contractor's invoice, which terms shall not be applicable to this Agreement and shall not be considered to be Contractor's exceptions to the provisions of this Agreement.

Counterparts: The parties may execute this Agreement by facsimile or other electronic means and in separate counterparts each of which when so executed and delivered shall be an original, and all such counterparts taken together shall constitute one instrument.

APPENDIX "B"

RISK MANAGEMENT AND SAFETY

A. INDEMNIFICATION AND INSURANCE

1. Indemnity and Waiver:

Contractor shall be liable to HRSB for and shall indemnify and save harmless HRSB from and against any and all claims, suits, demands, awards, actions, proceedings, losses, judgments, costs, damages, settlements or expenses (including legal costs on a solicitor and own client basis) suffered or incurred by HRSB that arise out of, result from, are based upon or are in any way connected with this Contract, including without limitation:

- (a) those resulting from any act or omission on the part of Contractor or its employees, agents and subcontractors;
- (b) those resulting from any action, suit or proceeding brought by any third party;
- (c) those brought in respect of personal injury (including injury resulting in death) or damage or destruction of tangible or intangible property, including HRSB's property;
- (d) those made under workers' compensation legislation;
- (e) those legal costs and fines resulting from the failure of Contractor, its employees, agents or subcontractors to comply with any applicable laws, regulations, by-laws, rules or orders of any government, authority or body having jurisdiction, whether identified in this Contract or applicable by-law;
- (f) those resulting from the release, discharge, seepage or other escape of any substance including chemicals, hazardous or toxic materials, substances, pollutants, contaminants or wastes, whether liquid, gaseous or of any other nature or for any breach of any applicable environmental legislation;
- (g) those resulting from any labourers', materialmen's, or mechanics' liens arising from or relating to the performance of the Contract;
- (h) those brought for actual, alleged, direct or contributory infringement of any patent, trademark, copyright, trade secret or other intellectual property right, including breach of obligations of confidentiality; and
- (i) any other claims, expenses, costs, and losses suffered, incurred or sustained by HRSB.

The foregoing liability, indemnification and hold harmless provisions shall apply to anything done or not done in connection with this Contract and by whomsoever made, regardless of whether it was caused by the negligence of Contractor or otherwise.

Contractor shall make no claim or demand against HRSB for any injury (including death), claim, expense, loss or damage to property suffered or sustained by Contractor or any other person which arises out of, or is connected, with this Contract or anything done or not done as required hereunder, or any other errors or omissions of Contractor, and hereby waives as against HRSB all such claims and demands.

The foregoing indemnity and waiver given by Contractor shall not apply to the extent of HRSB's own negligence. The onus of establishing that HRSB was negligent shall be upon Contractor. HRSB shall not be deemed to have caused or contributed thereto merely by reason of its knowledge, approval or acceptance of the materials, drawings,

specifications, supplies, equipment, procedures or services of Contractor.

For the purposes of this Section, any reference to "HRSB" shall include HRSB, together with the employees, directors, officers, superintendents, trustees, representatives and agents of HRSB; and any reference to "Contractor" shall include Contractor's directors, officers, employees, affiliates, representatives, agents and subcontractors.

2. Insurance:

Contractor shall, at its own expense, obtain and maintain during the term of this Contract, in a form and with an insurance company satisfactory to HRSB, policies of:

- (a) Commercial General Liability insurance with a limit of not less than Two Million Dollars (**\$5,000,000**) for any one loss or occurrence and in the aggregate with respect to bodily injury, personal injury and property damage, including loss of use thereof, which policy shall by its wording or by endorsement:
 - (i) include HRSB, its officers, directors, employees, agents and trustees as an additional insured with respect to the obligations assumed by Contractor under this Contract;
 - (ii) provide that, in relation to the interests of each additional insured, the Insurance shall not be invalidated by an action or inaction any other person other than the respective additional insured;
 - (iii) include a "cross liability" clause which shall have the effect of insuring each entity named in the policy as an insured in the same manner and to the same extent as if a separate policy had been issued to each;
 - (iv) extend to cover blanket Contractual liability, including the insurable liabilities assumed by Contractor under this Contract;
 - (v) extend to cover products and completed operations; such products and completed operations coverage, whether by specific policy endorsement respecting the services or by renewal of any annual practice policy, shall be kept in force during the supply of services and for a further period of 24 months following completion of supply of the services;
 - (vi) extend to cover non-owned auto liability coverage; and
 - (vii) not exclude any existing property of HRSB, but shall treat same as "third party property".
- (b) Employer's Liability Coverage which shall not be less than \$5,000,000 for each employee where Workers' Compensation coverage does not exist or the profession/trade has been indicated to be exempted from Workers' Compensation coverage.
- (c) Automobile public liability and property damage insurance in an amount not less than Two Million Dollars (\$2,000,000) all inclusive covering the ownership, use and operation of any motor vehicles and trailers which are owned, leased or controlled by the Contractor and used in connection with this Contract; and
- (d) Property "All Risks" insurance covering Contractor's owned property, including Contractor's equipment, where applicable, and property of others in the care, custody, or control of Contractor or for which the Contractor has assumed liability, all including while in transit or storage, on a replacement cost basis. With respect to any property of HRSB, such policy shall contain a loss payee

clause in favour of HRSB;
(collectively, the "Insurance").

Contractor shall ensure that the above Insurance policies:

- (a) are endorsed to provide HRSB with not less than thirty (30) days written notice in advance of cancellation, change or amendments restricting coverage;
- (b) do not include a deductible that exceeds such maximum amount that a reasonably prudent business person would consider reasonable; and
- (c) take the form of an occurrence basis policy and not a claims-made policy.

Contractor shall, before any services are performed, provide HRSB with a copy of the certificates of insurance and, if requested by HRSB, the insurance policies evidencing all the coverage stipulated above, and HRSB may withhold payment of any invoice until it receives evidence of such coverage. Failure for any reason to furnish this proof at any time shall be a breach of the contract, allowing the HRSB to terminate the contract or at the HRSB's option, to supply such insurance and charge the cost to Contractor. The HRSB may require Contractor to have the HRSB added as an insured party to the insurance policy and/or require Contractor to furnish a certified copy of the policy for such insurance.

Contractor shall not make or cause to be made any modification, or alteration to the Insurance, nor do or leave anything undone, which may invalidate the Insurance coverage. Contractor shall be responsible for any deductible and excluded loss under the Insurance.

Contractor shall cause all subcontractors performing services to obtain and maintain the Insurance policies required by this Section.

Contractor agrees that the insurance coverage required to be maintained by it under the provisions of this Contract shall in no manner limit or restrict its liabilities under this Contract. HRSB reserves the right to maintain the insurance in good standing at Contractor's expense and to require Contractor to obtain additional insurance where, in HRSB's reasonable opinion, the circumstances so warrant.

B. COMPLIANCE WITH LEGISLATION AND REGULATIONS

1. Compliance

Contractor shall comply with and shall ensure all of its agents, employees and subcontractors comply with all applicable laws and regulations, including all safety, health and environmental requirements pursuant to any government permit, license, or authorization. Contractor shall at its cost obtain all permits and licenses required by any governing authority in order to enable Contractor to provide its goods and services and otherwise perform its obligations under the Contract.

2. Labour Code

Contractor shall comply with all applicable provisions of the *Labour Code* (Nova Scotia) and the *Employment Standards Act* (Nova Scotia) and all regulations and amendments thereto.

3. Workers' Compensation Legislation

Contractor shall comply with the *Worker's Compensation Act* (Nova Scotia) and regulations and amendments thereto, and:

- (a) if any employees perform or assist in the performance of this Contract, the Contractor shall submit, at any time requested by the HRSB, a letter from the Workers' Compensation Board (Nova Scotia) stating that Contractor has an account in good standing with the Worker's Compensation Board;
- (b) the Contractor will make the necessary returns to the Workers' Compensation Board in accordance with government regulations and will pay all fees and contributions required in connection therewith. The cost of compensation will be included in the price payable under the Contract; and
- (c) the Contractor shall submit a clearance from the Workers' Compensation Board that all fees and contributions have been paid before final payment is made by the HRSB under the Contract.

4. Canada Safety Council and Associated Standards

All electrical, electronic and gas-fired equipment must bear the required approval markings, being C.S.A. approved for entirely electrical or electronic equipment and C.G.A. or C.S.A. approved for gas fired equipment. All other similar equipment approvals must also be obtained. It shall be the responsibility of the Contractor to obtain all applicable approvals, at its own expense.

5. Nova Scotia Occupational Health and Safety Legislation

Contractor shall comply at all times with the Nova Scotia Occupational Health and Safety Act, Regulation and Code, and it's amendments thereto.

C. SAFETY REQUIREMENTS

1. Safety Responsibility

Contractor shall be solely responsible for ensuring the safety and health of its agents, employees and subcontractors and for ensuring that its activities do not compromise the safety of HRSB's operations. Contractor shall provide to its agents, employees and subcontractors, at its own expense, any and all safety gear required to protect against injuries during the performance of the services and shall ensure that its agents, employees and subcontractors are knowledgeable of and utilize safe practices in the provision of the services, such practices to be at least as stringent as those set out in HRSB's safety standards provided to Contractor from time to time.

2. Project Site Protection and Safety

The Contractor shall protect the HRSB's property, staff and students, the Contractor's staff and the public, from damage or injury by providing adequate precautions to make the work site a safe environment at all times. In addition to complying with any safety standards provided to the Contractor by HRSB, the Contractor shall:

- (a) provide all guards and fences and other safety equipment;
- (b) respond to reports of hazards by HRSB;
- (c) do the following when work generating vibration, noise or safety concerns (including without limitation jack hammering, shot blasting, sandblasting, concrete cutting and use of powder actuated fasteners) may affect HRSB property, staff, students or operations.
 - (i) coordinate with HRSB representatives;
 - (ii) schedule and coordinate hours of work with HRSB input; and

- (iii) stop operations generating vibration, noise or safety concerns when instructed by HRSB.
- (d) Contractor responsible to ensure all spaces directly beneath the roof work area are protected from potential damage of dust, debris or water infiltration or any other impact resulting from the roof replacement project. Such protection shall include installation of effective cover using minimum 4 mil plastic vapour barrier sheeting over all furniture, equipment, instruction aids, floors areas and any other items underneath the work space. Contractor must remove all sheeting upon completion of work and will be responsible for costs of restoration of damages caused by process of roof project or lack of adequate protection of property.

3. Hazardous Materials

The Contractor shall:

- (a) develop and implement a written "Hazardous Materials Information" document to ensure that all persons at the work site are made aware of the existence of any hazardous materials such as asbestos, lead-based products, and PCB's;

D. CONTRACTOR EVALUATION

1. Audit

The HRSB reserves the right to audit Contractors and their subcontractor's health and safety performances during the term of the Contract and upon its conclusion.

2. Evaluation

The HRSB reserves the right to evaluate the performance of the Contractor and such evaluation will be based upon accident/injury data and adherence to this Schedule "C", the HRSB health and safety policies, applicable legislation, and periodic inspections and reports from HRSB employees. Information collected as part of such evaluations may be used for future reference.

E. HRSB REMEDIES FOR CONTRACTOR NON-COMPLIANCE

1. Emergency Work Stoppage

The HRSB has the authority to stop progress of the work whenever, in its opinion, such stoppage is desirable for any safety-related reason. The Contractor hereby agrees that no claim for loss of time or materials may be made with respect to such stoppage unless the claim for the time and materials and their value are certified in writing by the HRSB as allowable.

2. Termination for Non-Compliance

HRSB may terminate this Contract for non-compliance with health, safety, environmental and other applicable legislation and good industry practice on the part of the Contractor or any subcontractor of the Contractor, as constituting a material breach of this Contract. In addition, the HRSB reserves the right to stop the work of the Contractor in the event of Contractor's non-compliance with applicable legislation or good industry practice. Such work stoppages shall not postpone any agreed to completion dates and any additional cost

resulting from such work stoppages shall be borne by the Contractor. Work shall not resume until the Contractor rectifies the reason for non-compliance, to HRSB's satisfaction.

3. Non-Exclusive Remedies

Contractor acknowledges and agrees that the foregoing remedies available to HRSB are non-exclusive to, and may be exercised in conjunction with, any other rights or remedies available to HRSB, under the Contract, at law or in equity, in the event of threatened or actual breach of this Contract, including injunctive relief.

SAMPLE ONLY

APPENDIX "C"

DESCRIPTION OF SERVICES

- Description of Services to be performed by Contractor**, including any applicable standards of performance:

Description of Work:

As per Tender # drawings, specifications and scope of work

- Municipal and Legal Description of the Lands:**

Location of Work

- Term:** completion of work by ,

- Invoicing:** Services are to be paid for by HRSB:

- By scheduled progress payments (as agreed by both parties)
- By single invoice upon project completion

- Holdbacks:** In compliance with "Section 13 – Holdbacks" of the *Builder's Lien Act of Nova Scotia (incl. amendments)*, a holdback in the amount of ten percent (10%) of the contract may be held up to ninety (90) days after completion of the work, to the satisfaction of the Board.

- HRSB Project Manager /Contractor Contact Information:**

<p>CONTRACTOR INFORMATION</p> <p>Name:</p> <p>Jurisdiction of incorporation:</p> <p>Address:</p> <p>Attention:</p> <p>Telephone:</p> <p>Facsimile:</p> <p>E-mail:</p> <p>GST Registration #:</p> <p>WCB Registration #:</p>	<p>HRSB INFORMATION</p> <p>HRSB Representatives:</p> <p>Name:</p> <p>Department: Operations Services</p> <p>Address: 33 Spectacle Lake Drive Dartmouth, N.S., B3B 1X7</p> <p>Telephone: 902 464-2000 Ext.</p> <p>Facsimile: 902-</p> <p>E-mail:</p>

_____ _____
 Contractor's Initials HRSB's Initials

Exhibit A

Invitation To Tender

PROJECT SPECIFICATIONS/DRAWINGS WERE INCLUDED IN TENDER DOCUMENT AND ARE CONSIDERED PART OF THIS CONTRACT EVEN THOUGH THEY ARE NOT ATTACHED TO THIS DOCUMENT

Exhibit B

Response to Invitation to Tender

**A COPY OF THE SUCCESSFUL CONTRACTOR'S BID SUBMISSION IS ON FILE IN
THE PURCHASING DEPARTMENT - TENDER #3437**

APPENDIX "D"

**UNDERTAKING TO COMPLY FORM
AND CONTRACTOR SAFETY CHECKLIST**

UNDERTAKING TO COMPLY

Name of Contractor:

(the "Contractor")

Description of Agreement:

Site Location:

(the "Agreement")

7. The Contractor hereby undertakes to HRSB:
to comply with all health, safety and environmental legislation in the performance of this Agreement; and
to maintain a safe and healthy work environment during the performance of this Agreement.
8. The Contractor hereby agrees with HRSB:
that compliance with all health, safety and environmental legislation is a condition of this Agreement and that non-compliance with the same may, in HRSB's discretion, lead to the termination of this Agreement; and
to permit HRSB to audit the Contractor's health, safety and environmental records during the term of this Agreement and upon its conclusion and to cooperate fully with any such audit(s).
9. The Contractor understands that, at HRSB's discretion, any Contractor safety deficiencies will be addressed by HRSB in the following progressive steps:
the problems will be identified to the Contractor (site supervisor);
the Contractor's head office will be contacted about the problem, orally and later in writing;
if required by law to report the problem to a Provincial and or Federal Ministry, HRSB will immediately do so;
if not required by law to report the problem, and the problem remains unresolved, HRSB may report the problem; and
the Agreement may, in HRSB's discretion, be suspended or terminated and/or payment withheld by HRSB.

- 10. The Contractor acknowledges and agrees with HRSB that, depending upon the nature and/or seriousness of the deficiency, HRSB reserves the right to bypass any or all of the steps described in Section 3.
- 11. **Prime Contractor Designation:** The Contractor and the HRSB hereby agree that the Contractor shall, pursuant to Section 8.4 of the Agreement shall be the Prime Contractor.

The undersigned hereby confirms that he/she has the authority to bind the Contractor:

CONTRACTOR

**HALIFAX REGIONAL
SCHOOL BOARD**

FULL COMPANY NAME

PRINT NAME

AUTHORIZED SIGNATURE

POSITION

DATE

PRINT NAME

AUTHORIZED SIGNATURE

POSITION

DATE

SAMPLE ONLY

PRE-CONSTRUCTION MEETING
CONTRACTOR SAFETY CHECKLIST PAGE 1

MEETING DATE:	TENDER #:
----------------------	------------------

SITE LOCATION:

COMPANY NAME:

CONTRACTOR REPRESENTATIVE::

HRSB REPRESENTATIVE::

√ Means complied to	X Means not complied with	n/a means not applicable
----------------------------	----------------------------------	---------------------------------

- | | |
|---|---|
| <p>1. Notice of Project filed with Nova Scotia Infrastructure (if applicable) <input type="checkbox"/></p> <p>2. Review Board Safety Compliance Undertaking to Comply Form Signed <input type="checkbox"/></p> <p>Progressive Disciplinary Action Reviewed <input type="checkbox"/></p> <p>3. Contractor Health and Safety Policy <input type="checkbox"/></p> <p>Prime Contractor and Safety Management Certificate <input type="checkbox"/></p> <p>4. Health & Safety Representatives/Joint Site Health & Safety Committee <input type="checkbox"/></p> <p>Name and Phone _____ <input type="checkbox"/></p> <p>5. Personal Protective Equipment:
 Hard Hats <input type="checkbox"/>
 Footwear <input type="checkbox"/>
 Safety Glasses <input type="checkbox"/></p> | <p>8. Contractor Staff Training:
 Emergency Response <input type="checkbox"/></p> <p>WHMIS Training Verification <input type="checkbox"/></p> <p>O H & S <input type="checkbox"/></p> <p>MSDS Received <input type="checkbox"/></p> <p>Scaffold <input type="checkbox"/></p> <p>Confined Space Code of Practice <input type="checkbox"/></p> <p>TDG Training Verification <input type="checkbox"/></p> <p>Working Alone <input type="checkbox"/></p> <p>9. Review Contractor Signage & Barricades <input type="checkbox"/></p> <p>10. Written Work Site Hazard Assessment and Control Plan/Schedule Submitted <input type="checkbox"/></p> <p>11. Building Fire Plan <input type="checkbox"/></p> |
|---|---|

SAMPLE ONLY

CONTRACTOR SAFETY CHECKLIST – PAGE 2

- | | | | |
|---|--------------------------|---|--------------------------|
| Hearing | <input type="checkbox"/> | 12. Accident Investigation/Notification/Reporting Procedure | <input type="checkbox"/> |
| Dust & Fumes | <input type="checkbox"/> | | |
| Face Protection | <input type="checkbox"/> | | |
| Others: _____ | <input type="checkbox"/> | 13. Contingency Plan for Control & Clean up of a Spill | <input type="checkbox"/> |
| _____ | <input type="checkbox"/> | | |
| _____ | <input type="checkbox"/> | 14. Fire Protection/Extinguishers | <input type="checkbox"/> |
| | | | |
| 6. Equipment Certification | | 15. First Aid Kits on Site | <input type="checkbox"/> |
| Trench Boxes | <input type="checkbox"/> | | |
| | | 16. First Aiders on Staff | <input type="checkbox"/> |
| Boom Cranes | <input type="checkbox"/> | Names: _____ | |
| Scaffolds | <input type="checkbox"/> | | |
| Others: _____ | <input type="checkbox"/> | 17. Fall Protection /Safety Harness | <input type="checkbox"/> |
| _____ | <input type="checkbox"/> | | |
| _____ | <input type="checkbox"/> | 18. Methane gas Detection in Sewer | <input type="checkbox"/> |
| | | | |
| 7. Provision of Hazardous Material Information to Contract | <input type="checkbox"/> | 19. Clean Up - Good Housekeeping | <input type="checkbox"/> |
| Confirmation of Employee Awareness of Hazardous Material | <input type="checkbox"/> | | |
| Asbestos | <input type="checkbox"/> | 20. Weekly Safety Talks/Meetings | <input type="checkbox"/> |
| Lead | <input type="checkbox"/> | | |
| PCB | | | |
| Confirmation that Prime Contractor reviewed Asbestos Inventory at the work site | <input type="checkbox"/> | 21. Other Issues | <input type="checkbox"/> |

SAMPLE ONLY



APPENDIX E

Project Safety Plan Outline

During the planning of each project, environmental and occupational health and safety issues will be assessed like any other key project component.

Prior to beginning a new project, tendering Contractors shall examine the work area to identify potentially hazardous site specific situations.

Once identified, these hazards should be prioritized on this Hazard Assessments/Project Safety Plan Outline and corrective *actions* noted to eliminate or control each hazard. The dates of when and names of the persons who are responsible for completing the *action* should also be assigned.

Copies of the completed Safety Plan Outline shall be submitted as part of the tender document submittal, sent to the HRSB Operations Services Regional Manager, made available on the job site and communicated to the workers.

Project Name: _____

Project Location: _____

Project Start date: _____

Project End date: _____

Company Name: _____

Completed by: _____
(Contractor's project manager)

Date: _____

Copy to: _____

PLANNING:

Does the Contractor's Occupational Health and Safety Program deal with the work activities associated with this project? Yes No

Describe tasks to be undertaken: _____

HAZARDS ASSESSMENT:

Identify the hazards that could present themselves on this project (e.g. live electrical wires, over water, confined space, etc) and describe what steps will be taken to prevent an incident (e.g. cover up, de-energize, safe work practices, netting, etc). Prioritize from #1 as needing immediate action.

#	Hazard	Required Action	Completed by	Date
1				
2				
3				
4				
5				
6				
7				
8				
9				
10				

ENVIRONMENTAL ASSESSMENT:

Identify the environmental issues that could present themselves on this project (e.g. oil spills, asbestos, etc.) and describe the action that will be taken to eliminate or reduce the risk of occurrence (e.g. mop kits, air sampling, etc.)

#	Hazard	Required Action	Completed by	Date
1				
2				
3				
4				
5				

EMERGENCY RESPONSE:

In the event of an incident, pre-plan the response and write up the procedures. Minimally, the following list should be completed and posted on site:

Contact	Phone #	Contact	Phone #
Fire	911	Poison Control	428-8161
Ambulance	911	Dangerous Goods	1-800-565-1633
Doctor	911	Waste Disposal	
Police	911	Insurance	
HRSB Office	493-5110	Min/Dept of Labour	1-800-952-2687
Min./Dept.of Transport.		Min/Dept of Environment	1-800-565-1633

- Identify and arrange source of first aid, ambulance and rescue.
- Accidents will be reported to: _____
- Accidents will be investigated by: _____
- Back-up call to: _____
- HRSB # emergency/after hours: day 493-5110 after 4:00 pm 442-2476

SAFETY MEETINGS:

On this project, given the nature of the work and the anticipated size of the work force, the following frequency will apply:

Site meetings _____

Site Audits _____

Follow up with HRSB Manager: _____

SITE IMPLEMENTATION:

- Health and Safety Rep & Safety Committee:
Establish liaison between HRSB, Contractor, site administration
First Aid, PPE, other safety items as required.

- Documentation:
Applicable MSDS
Safety program
Applicable work procedures
Permits
First Aid Certification

TRAINING:

The following training/testing will be mandatory on site:

1) _____

2) _____

3) _____

TENTATIVE SCHEDULE OF WORK:

- 1) Date Project Will Commence: _____
- 2) Number of Weeks to Complete Project: _____ weeks
- 3) Expected Completion Date: _____

NOTE:

Within two weeks of tender award the successful bidder shall provide a schedule clearly indicating timelines for completion of all aspects of the project.

APPENDIX F

CONTRACTOR'S CHECKLIST

Enclose the following documents with your bid:

- Bid Security as required in Clause 1.3 (e)*** in the amount of 10% of the Contract Price (before HST).
- Contract Security for bids over \$100,000 as required in Clause 1.3 (f).***
- Certificate of Insurance*** indicating a minimum of **\$5,000,000 Commercial General Liability Insurance** per occurrence and **Commercial Auto Liability Insurance** covering all owned, non-owned and hired vehicles for a minimum combined single limit of **\$2,000,000** per occurrence and **Builder's Risk Insurance** in the amount of the contract price.
- Tentative Work Schedule (Timelines)*** – Subsequently, within five (5) business days of tender award the successful bidder shall provide a schedule clearly indicating timelines for completion of all aspects of the project.
- Workers' Compensation Board Letter*** of Good Standing
- Certificate of Recognition from one of the seven safety audit companies that jointly sign with the WCB:***
 - East Coast Mobile Medical Inc.
 - HSE Integrated
 - Nova Scotia Construction Safety Association
 - Nova Scotia Trucking Safety Association
 - Occupational Health & Educational Services (2002) Inc.
 - Safety Services Nova Scotia
 - Stantec Inc.

This list can be found on WCB's website: www.wcb.ns.ca.
- Completed HRSB Safety Plan***
- Applicable Warranty Information***

The Executed Agreement of the Halifax Regional School Board is to be read in conjunction with this Section.

PART 1 - GENERAL

1.1 SUMMARY OF SECTION

- .1 As summarized and described but not restricted to the following:
 - .1 Provide rough carpentry for work from other sections as noted.
 - .2 Provide rough carpentry work as indicated in Schedule.

1.2 REFERENCES

- .1 The standards listed form part of this Specification to the extent of reference. The publications are in the text by the basic designation only.
- .2 American Society for Testing and Materials International (ASTM):
 - .1 ASTM A123/123M-13 Standard Specification for Zinc (Hot Dipped Galvanized) Coatings on Iron and Steel Products.
 - .2 ASTM F1667 -11ae1, Standard Specification for Driven Fasteners: Nails, Spikes, and Staples.
 - .3 ASTM A653/A653M-13, Standard Specification for Steel Sheet, Zinc-Coated (Galvanized) or Zinc-Iron Alloy-Coated (Galvannealed) by the Hot-Dip Process for G-185 fasteners for use with ACQ wood
- .3 American Wood Protection Association (AWPA), Alkaline Copper Quarternary (ACQ) for all pressure treated wood.
- .4 Canadian Standards Association (CSA):
 - .1 CSA-B111-1974 (R2003), Wire Nails, Spikes and Staples.
 - .2 CAN/CSA-G164-M92 (R2003), Hot Dip Galvanizing of Irregularly Shaped Articles.
 - .3 CSA O80S2-05 Supplement to O80 Series-97, Wood Preservation
 - .4 CSA O151-09(R2014), Canadian Softwood Plywood.
- .5 ISO 14040:2006, Environmental management, Life Cycle Assessment, Principles and Framework.
- .6 National Building Code of Canada (NBCC) 2010.
- .7 National Lumber Grades Authority (NLGA), Standard Grading Rules for Canadian Lumber, 2010.

1.3 ENVIRONMENTAL REQUIREMENTS

- .1 Comply with requirements of Workplace Hazardous Materials Information System (WHMIS) regarding use, handling, storage and disposal of materials.
-

1.4 WASTE MANAGEMENT

- .1 Separate and recycle waste materials in accordance with Division 01 Requirements.
- .2 Separate wood waste and place in designated areas in the following categories for recycling: Solid wood/ softwood/ hardwood, composite wood, treated, painted, or contaminated wood in containers supplied by the Contractor.
- .3 Set aside damaged wood and dimensional lumber off-cuts for acceptable alternative uses (e.g. bracing, blocking, cripples, bridging, finger-joining, or ties). Store this separated reusable wood waste convenient to cutting station and area of work.
- .4 Do not burn scrap at the project site.
- .5 Separate corrugated cardboard and recycle.

1.5 DELIVERY, STORAGE AND PROTECTION OF PRODUCT

- .1 Deliver and store materials in compliance with Division 01 Requirements.
- .2 Comply with manufacturer's recommendations for handling, storage and protection during installation.
- .3 Protect and store materials off the ground, away from physical damage and from becoming wet, soiled or covered with ice or snow before, during and after installation.
- .4 Label packages to include material name, production date and/or product code.

1.6 QUALITY ASSURANCE/QUALITY CONTROL

- .1 Lumber identification: by grade stamp of an agency certified by Canadian Lumber Standards Accreditation Board.
- .2 Plywood identification: by grade mark in accordance with applicable CSA standards.

PART 2 - PRODUCTS

2.1 LUMBER MATERIAL

- .1 Softwood Lumber: unless specified otherwise:
 - .1 Softwood, SPF Species, NLGA Grade 2 (or better).
 - .2 G4S, (good four sides)
 - .3 Moisture content 19% or less in accordance with:
 - .1 CSA-O141
 - .2 NLGA Standard Grading Rules for Canadian Lumber
-

- .2 Furring, blocking, nailing strips: cants, curbs, backing and sleepers:
 - .1 Softwood, SPF series, NLGA Standard or better grade.
 - .2 Moisture content: 19% or less, in accordance with:
 - .1 CSA-O141
 - .2 NLGA Standard Grading Rules for Canadian Lumber.
- .3 The manufacturing process must adhere to Lifecycle Assessment (LCA) standards as per ISO 14040.
- .4 Use pressure treated lumber for all roof related items and when wood is in contact with concrete.
 - .1 Pressure treated wood (Alkaline Copper Quarternary) treatment in accordance with CSA-O80 Series

2.2 SOFT WOOD PANEL MATERIALS

- .1 Canadian Softwood Plywood: to CSA O151, standard construction.
- .2 Use pressure treated panels for all roof related items and when wood is in contact with concrete.
 - .1 Pressure treated wood (Alkaline Copper Quarternary) treatment in accordance with CSA-O80 Series.

2.3 FASTENERS

- .1 Nails, spikes and staples: to CSA B111 and ASTM F1667.
- .2 Bolts: 1/2" min. diameter unless indicated otherwise, complete with nuts and washers.
- .3 Proprietary fasteners: toggle bolts, expansion shields and lag bolts, screws and lead or inorganic fiber plugs, explosive actuated fastening devices, recommended for purpose by manufacturer.
- .4 Fasteners for ACQ wood must be galvanized to G-185 (as defined in ASTM A653/A653M) or better, stainless steel or ceramic coated fasteners approved for use with ACQ wood.

2.4 SEMI-RIGID INSULATION

- .1 Semi-Rigid Fibrous Insulation:
 - .1 Standard of Acceptance: specification based on Roxul Inc Semi-Rigid board, or approved alternate.
 - .2 Board Density: ASTM C612, 4.4 lbs/ft³ or 70 kg/m³
 - .3 Board Size: 16" (406 mm) OR 24" (610 mm) wide by 48" (1219 mm) long.
 - .4 Board Thickness: 1" (25 mm), OR 1.5" (38 mm), 2" (50 mm)
 - .5 Facing: unfaced
 - .6 Non-Combustable: ASTM E136, CAN/ULC S114
-

- .7 Thermal Resistance: R-Value 4.2 per inch. RSI-Value: 0.74m² k/w
- .8 Moisture Resistance: ASTM C1104, Moisture Absorption: 0.03% volume
- .9 Water Vapour Permeance: ASTM E96 (33.1 perm)
- .10 Acceptable Alternate Manufacturers:
 - .1 Thermafibre Inc.

PART 3 - EXECUTION

3.1 EXAMINATION

- .1 Verify that field conditions are acceptable and are ready to receive Work.
- .2 Site verify dimensions, tolerances and method of attachment with other Work.

3.2 INSTALLATION

- .1 Comply with requirements of NBC 2010.
- .2 Install rough bucks, nailers and linings to rough openings as required to provide backing for frames and other work.
- .3 Install sleepers as indicated.
- .4 Provide space framing and furring as indicated.
- .5 Align and plumb faces of furring and blocking to tolerance of 1:600.
- .6 Install backing, nailers, curbs and other wood supports as required, secure using ACQ approved fasteners at exterior locations.
- .7 Frame, anchor, fasten, tie and brace members to provide necessary strength and rigidity.
- .8 Countersink bolts where necessary to provide clearance for other work.

3.3 SCHEDULE

- .1 Roof Curbs for Parapets and Mechanical Equipment:
 - .1 Construction & Anchorage:
 - .1 PT 2x4 wood studs at 16" o.c.
 - .2 ½" pressure treated plywood, both sides mechanically fastened at 6" o.c.
 - .3 Semi Rigid Batt Insulation; Standard of Acceptance Roxul or Thermafibre or accepted alternate
 - .4 Refer to details for height of curb and extent.
 - .5 Ensure curb is leveled around perimeter.
 - .2 Optional Assembly: Solid wood curb constructed of built-up layers of PT wood.

- .2 Roof Curbs for Chimneys:
 - .1 Construction & Anchorage:
 - .1 6" steel studs at 16" o.c.
 - .2 ½" overlayment board, both sides mechanically fastened at 6" o.c.
 - .3 Semi Rigid Batt Insulation; Standard of Acceptance Roxul or Thermafibre or accepted alternate
 - .4 Refer to details for height and extent of chimney surround.
 - .5 Ensure curb is leveled around perimeter.

3.4 CLEANING

- .1 Perform cleaning as soon as possible after installation to remove construction and accumulated environmental dirt.
- .2 Upon completion of installation, remove surplus materials, rubbish, tools and equipment barriers.

END

The Executed Agreement of the Halifax Regional School Board is to be read in conjunction with this Section.

PART 1 - GENERAL

1.1 SUMMARY OF SECTION

- .1 As summarized and described herein, but not restricted to the following:
 - .1 Remove the existing 4-ply built up roofing system, flashing, insulation, vapour barrier, down to the existing metal deck as noted on the drawings.
 - .2 Provide new two-ply modified bituminous membrane roofing system as noted on drawings with provision for FM Class 1-90 wind uplift standards.
 - .3 To temporarily remove mechanical exhaust fans, and provide new curbs and upstand, provide metal duct extensions, and replace once roofing and flashing is in place.
 - .4 Provide all built-up parapets, blocking curb extensions as required.
 - .5 Provide new roof drains where noted on the documents.
 - .6 Provide new roof flashing tie-ins to existing wall systems.
 - .7 To provide fit-ups to roof deck if uncovered and has deteriorated, as a Unit Price. Refer to paragraph 1.4 of this section and Tender/Bid Document for additional information.

1.2 ACCEPTABLE ROOFING ASSEMBLIES

- .1 The following assemblies are acceptable for use on this project. Materials are listed in Part 2. Alternate assemblies will only be considered during the bidding phase.
 - .1 Roof Assembly option 'A'
 - .1 Existing roof deck to remain.
 - .2 ½" Underlayment Board
 - .3 Vapour Barrier
 - .4 Expanded Polystyrene Rigid Insulation
 - .5 ½" Overlayment Board – mechanically fastened to 1-90
 - .6 ½" Overlayment Board – cold adhered
 - .7 Modified Bitumen Base – cold adhered
 - .8 Modified Bitumen Cap – torch applied
 - .2 Roof Assembly option 'B'
 - .1 Existing roof deck to remain.
 - .2 ½" Underlayment Board
 - .3 Vapour Barrier
 - .4 Expanded Polystyrene Rigid Insulation
 - .5 ½" Overlayment Board – mechanically fastened to 1-90
 - .6 ½" Overlayment Board with Modified Bitumen Base – cold adhered
 - .7 Modified Bitumen Cap – torch applied
-

- .3 Roof Assembly option 'C'
 - .1 Existing roof deck to remain.
 - .2 ½" Underlayment Board
 - .3 Vapour Barrier
 - .4 Polyisocyanurate Rigid Insulation– mechanically fastened to 1-90
 - .5 ½" Overlayment Board – cold adhered
 - .6 Modified Bitumen Base – cold adhered
 - .7 Modified Bitumen Cap – torch applied

- .4 Roof Assembly option 'D'
 - .1 Existing roof deck to remain.
 - .2 ½" Underlayment Board
 - .3 Vapour Barrier
 - .4 Polyisocyanurate Rigid Insulation– mechanically fastened to 1-90
 - .5 ½" Overlayment Board with Modified Bitumen Base – cold adhered
 - .6 Modified Bitumen Cap – torch applied

1.3 REFERENCES

- .1 American National Standards Institute (ANSI) Factory Mutual (FM):
 - .1 ANSI/FM Approval 4474, Evaluating the Simulated Wind Uplift Resistance of Roof Assemblies Using Static Positive and/or Negative Differential Pressures (Class range from 1-60 to 1-990).

- .2 American Society for Testing and Materials International (ASTM):
 - .1 ASTM C208-12, Specification for Cellulosic Fiber Insulating Board.
 - .2 ASTM C578-12b, Specification for Rigid, Cellular Polystyrene Thermal Insulation.
 - .3 ASTM C1177/C1177M-13, Glass Mat Gypsum Substrate for Use as Sheathing
 - .4 ASTM D6164/D6164M-11, Styrene Butadiene Styrene (SBS) Modified Bituminous Sheet Materials Using Polyester Reinforcements.
 - .5 ASTM D4586/D4586M-07(2012)e1, Asphalt Roof Cement, Asbestos Free

- ..3 Canadian General Standards Board:
 - .1 CGSB 37-GP-9Ma, Primer, Asphalt, Unfilled, for Asphalt Roofing, Dampproofing and Waterproofing.

- .4 Canadian Roofing Contractors' Association (CRCA) – Roofing Specifications Manual.

- .5 Nova Scotia Construction Safety Association (NSCSA), Occupational Health and Safety Act (OHSA)

- .6 Underwriters Laboratories of Canada (ULC):
 - .1 CAN/ULC S701-11 EN, Standard for Thermal Insulation, Polystyrene, Boards and Pipe Covering.

1.4 UNIT PRICES

- .1 Refer to the Tender/Bid Documents for Unit Prices:
 - .1 Unit Price #1: Provide a Unit Price for the replacement of the existing roof decking.
 - .2 Unit Price #2: Provide a Unit Price for the replacement of the existing wood blocking, parapets, and/or curbs that are noted to remain, but that may contain rot and/or damage, if deemed unusable.

1.5 SUBMITTALS

- .1 Provide shop drawings including manufacturers technical data sheets and installation methods for each component. Include a summary of the roofing system from top to bottom.
 - .1 Ensure manufacturer products specified are as prescribed by FM Class 1-90 wind uplift recommendations.
 - .2 Provide layout for tapered areas of rigid insulation. Ensure tapered insulation noted for roof areas indicate a positive slope to drain.
 - .3 Provide fastening layouts meeting FM Class 1-90 requirements, for field, edge and corner locations.

1.6 ENVIRONMENTAL REQUIREMENTS

- .1 Comply with requirements of Workplace Hazardous Materials Information System (WHMIS) regarding use, handling, storage and disposal of materials.
- .2 Refer to the Manufacturer's recommendations regarding installation of roofing system at ambient temperatures. Roofing system should be applied when temperatures are above 0°C.
- .3 Refer to the Manufacturer's recommendations of temperatures required for conditioning the materials prior to application and install and curing after.
- .4 Install roofing on dry deck, free of snow and ice, use only dry materials and apply only during weather that will not introduce moisture into roofing system.
- .5 Only 'Dry' materials are to be installed. Materials that are installed wet, or materials that become wet during inclement weather to be removed and replaced.

1.7 SAFETY REQUIREMENTS

- .1 Refer to the HRSB Documents on Safety.
 - .2 Contractor to abide by NSCSA Occupational Health and Safety Act.
-

- .3 Ensure all roof installers have taken the NSCSA Fall Protection course and abide by the NSCSA Fall Protection Course Guidelines.
- .4 Contractor to be cognizant of proper protection of removal of roofing from the building and site. Ensure Project Manager is advised re the proposed location and protection.

1.8 WASTE MANAGEMENT

- .1 Contractor to remove debris immediately from site to a designated landfill approved by Provincial Regulations to accept existing roofing materials debris.

1.9 PERFORMANCE CRITERIA

- .1 Compatibility between components of roofing system is essential. Provide written declaration to Consultant stating that materials and components, as assembled in system, meet this requirement.
- .2 Do roofing work in accordance with applicable, standard in Canadian Roofing Contractors Association (CRCA) Roofing Specifications Manual and to prescribed FM Class 1-90 wind uplift requirements where mechanically fastened.

1.10 DELIVERY, STORAGE AND PROTECTION OF PRODUCT

- .1 Comply with manufacturer's recommendations for handling, storage and protection during installation.
 - .2 Protect and store materials off the ground, away from physical damage and from becoming wet, soiled or covered with ice or snow before, during and after installation.
 - .3 Removal and replacement of roof drains and removal and reinstatement of existing mechanical units to be completed by a subcontractor qualified to complete the identified work.
 - .4 Label packages to include material name, production date and/or product code.
 - .5 Store rolls of felt and membrane in upright position. Store membrane rolls with salvage edge up.
 - .6 Remove only in quantities required for same day use.
 - .7 Place plywood runways over work to enable movement of material and other traffic.
 - .8 Store roofing material at +5C minimum.
-

1.11 QUALITY ASSURANCE/QUALITY CONTROL

- .1 Convene pre-installation meeting one week prior to beginning work of this Section.
 - .1 Verify project requirements.
 - .2 Review installation and substrate conditions.
 - .3 Co-ordinate with other building subtrades.
 - .4 Review manufacturer's installation instructions and warranty requirements.
 - .5 Record meeting proceedings including corrective measures and other actions required to ensure successful completion of work and distribute to each attendee within one week of meeting.
- .2 Certificates: product certificates signed by manufacturer certifying materials comply with specified performance characteristics and criteria and physical requirements.
- .3 Roofing applicator must be a good standing member of the CRCA and approved by the Roof Manufacturing Company selected on this Project, and have completed projects of this magnitude in the last five (5) years.
- .4 Contractor to hold pre-construction meeting with Manufacturer's Technical Representative to review the substrate condition and review the process of installation. Manufacturer's Representative to visit site three (3) times unannounced during construction and once at completion and provide inspection reports to the Consultant.

1.12 FIRE WATCH

- .1 Fire Extinguishers: maintain one cartridge operated type with hose and shut-off nozzle, ULC labelled for A, B and C class protection, within 3 meters of torch applicator.
- .2 Cease torching at least three (3) hours before leaving for the day and maintain fire watch for two (2) hours after each day's roofing operations cease.
- .3 Designate a person, equipped with a fire extinguisher and a cell phone, responsible in the event of a fire, to do a mandatory walk-about to check for hot spots.
- .4 Make sure all workers know the escape route.

1.13 TEST REPORTS

- .1 If required by the Owner, provide a third party roof inspection company to check and verify all systems from Shop Drawing review, to Roof preconstruction. Meetings to review during the application of the system.
 - .2 Provide interim written reports during the application to the Consultant.
 - .3 Infrared testing of the entire roof will be required and will include all field applications. Testing of flashing: at cap flashing, roof to wall flashing, etc., and at all roof drains. Provide infrared testing of all seam testing.
-

- .4 Qualifications of the required test will be as follows:
 - .1 Upon completion of the Primary Waterproofing Membrane, Protection Course, and all associated terminations, the Contractor shall test the system.
 - .2 Repair and retest the system, report all deficiencies to the Consultant.
 - .3 No other Work is to proceed without prior direction from the Consultant.
- .5 Submit copies of all test reports to the Consultant.
- .6 All costs of the third party testing, if required, will be borne by the Owner.

1.14 WARRANTIES

- .1 Roofing Contractor to supply the Owner with a CRCA warranty certifying work completed as installed to be free of roof defect for a period of two (2) years from date of substantial performance.
- .2 Provide manufacturer's membrane warranty (non-pro-rated) in the name of the Owner, stating roofing system will remain watertight for a period of a full ten (10) years from the date of substantial completion. This warranty is to include both labour and materials necessary to affect water tightness.

PART 2 - PRODUCTS

2.1 UNDERLAYMENT BOARD

- .1 Mold and Moisture Resistant, non-combustible, solid core underlayment board to provide smooth surface for Air/Vapour Barrier application.
- .2 Manufactured as per ASTM C1177/C1177M.
- .3 Size Boards: 48" (1220 mm) wide x 96" (2440 mm) long x 1/2" (12.7mm) thick minimum.
- .4 Standard of Acceptance based on the following, or approved alternate:
 - .1 CGC Securock Glass mat Roof Board
 - .2 Georgia Pacific DensDeck Prime Roof Board.

2.2 VAPOUR BARRIER

- .1 SBS Modified bitumen, self-adhering membrane, reinforced with skid resistant polyethylene surface film.
 - .2 Self gasketing material with fully adhered system that has split release backing for fast application.
-

- .3 Suitable for application on top of roof underlayment board and serves as full coverage waterproofing layer in roof assembly.
- .4 Primer as required by manufacturer.
- .5 Thickness: 1.0 mm (40 mils)
- .6 Water Vapour Transmission: 0.05 perms
- .7 Standard of Acceptance: Blueskin PE 200 HT by Henry Company
- .8 Approved Alternates:
 - .1 IKO MVP
 - .2 Soprema Sopravap'r

2.3 EXPANDED POLYSTYRENE INSULATION

- .1 Polystyrene Insulation Type I or Type II Board manufactured to CAN/ULC-S701 and ASTM C578. Contains no CFC, HCFC or HFC blowing agents.
- .2 Size Board: 4'-0" (1220 mm) x 4'-0" (1220 mm)
- .3 Thermal Resistance: R value = R30
- .4 Tapered Insulation: where noted on the drawings.
- .5 Edges ship lapped, or insulation applied in two layers with staggered joints.

2.4 POLYISOCYANURATE RIGID INSULATION

- .1 Polyisocyanurate roof insulation Type 2 or Type 3 manufactured to CAN/ULC-S704-03 or CAN/ULC-S704-11.
 - .2 Size Board: 4'-0" (1220 mm) x 4'-0" (1220 mm) or 4'-0" (1220 mm) x 8'-0" (2440 mm)
 - .3 Physical Properties
 - .1 Compressive strength: 140kPa minimum
 - .2 Water absorption: 3.5% max (by volume)
 - .4 Thermal Resistance: R value = R30
 - .5 Mechanically fastened through deck with purpose made screws and plates. Fastening is to meet 1-90 wind uplift requirements.
 - .6 Tapered Insulation: refer to roof plans for extent and dimensions of tapered insulation.
 - .7 Edges ship lapped, or insulation applied in two layers with staggered joints
-

2.5 ROOFING ADHESIVES

- .1 Insulation and Overlayment Board Adhesive:
 - .1 Must be compatible with roofing system components, and meet roofing warranty requirements.
 - .2 Meets 1-90 wind uplift requirements.
 - .3 Low rise, low odor, foam adhesive.
 - .4 IKO Millennium or equivalent
- .2 Membrane Adhesive:
 - .1 Must be compatible with roofing system components, and meet roofing warranty requirements.
 - .2 Meets 1-90 wind uplift requirements.
 - .3 Solvent-free adhesive designed for cold application of roofing membranes.
 - .4 IKO Cold Gold adhesive or equivalent

2.6 OVERLAYMENT BOARD

- .1 Uniform, moisture resistant, fiberboard with premium wax resins to ASTM C208 high density, Type II, Grade 2.
- .2 Size boards: 4' (1220mm) x 8' (2440mm)
- .3 Thickness boards: 1/2" (13mm)
- .4 Physical Properties:
 - .1 Compressive Strength: 240 kPa min.
 - .2 Water Absorption: 7% volume max.
 - .3 Linear expansion: 0.5% max.
- .5 Acceptable Products:
 - .1 Vanguard Fiberboard High Density
 - .2 IKO Protection Board – Protectoboard
 - .3 Georgia Pacific commercial roof fiberboard
 - .4 Soprema Sopraboard
 - .5 Celotex Structodek

2.7 OVERLAYMENT BOARD WITH INTEGRAL BASE SHEET

- .1 1/2" high density fibreboard with integral 180 g/m base sheet. Top face thermofusible film for torch application of cap sheet.
 - .2 Meets CAN/ULC-S706 and ASTM C208
 - .3 Cold adhered installation only, to meet 1-90 wind uplift requirements.
-

- .4 Membrane edges self-adhesive or cold adhered.
- .5 Acceptable products: Roofcraft-180-base-f/r-polyester, Lexbase-180-fr-Polyester or approved alternate.

2.8 ROOF MEMBRANES

- .1 Base Sheet: 180 g/m:
 - .1 Non-woven reinforcing matt, polyester coated and permeated with SBS modified bitumen. This membrane is applied with cold adhesive.
 - .2 Thickness: 2.2mm (87mils)
 - .3 Bottom side coated with sand to allow adhesion with cold process adhesive.
 - .4 Top surface thermofusible film to allow adhesion with torch applied cap.
 - .5 Manufactured to ASTM D6164 for Type 1, Grade 'S' materials.
 - .6 Standard of Acceptance based on IKO MP-180-FS-Base.
 - .7 Approved Alternate Manufacturers:
 - .1 Soprema
 - .2 Bakor by Henry Company
 - .3 Polyglass
 - .2 Base Sheet Flashing 180 g/m:
 - .1 Non-woven reinforcing matt, polyester coated and permeated with Modiflex SBS bitumen, self-adhering one side, thermo fusible plastic film over.
 - .2 Thickness: 2.5mm (98mils)
 - .3 Poly Film (thermo fusible) covers the top surface; the back surface is self-adhered, silicone treated film.
 - .4 Manufactured to ASTM D6164.
 - .5 Primer as per manufacturer's recommendations.
 - .6 Standard of Acceptance based on IKO Armour Bond Flash.
 - .7 Approved Alternate Manufacturers:
 - .1 Soprema
 - .2 Bakor by Henry Company
 - .3 Polyglass
 - .3 Cap Sheet and Cap Flashing 250g/m:
 - .1 Non-woven reinforcing mat, strengthened with selected glass fibre strands, coated and permeated with SBS modified bitumen. The underside to be protected by thermofusible plastic film. Membrane to be applied by torching only.
 - .2 Thickness: 4.0mm (158mils)
 - .3 Coloured ceramic mineral granules embedded into top surface to provide protection against ultraviolet radiation.
 - .4 Manufactured to ASTM D6164 for Type II, Grade G materials.
 - .5 Standard of Acceptance based on IKO Torchflex TP 250 CAP
 - .6 Approved Alternate manufacturers:
 - .1 Soprema
 - .2 Bakor by Henry Company.
 - .3 Polyglass
-

PART 3 - EXECUTION

3.1 EXAMINATION

- .1 Manufacturer's Technical Representative to examine roof decks and immediately inform the Consultant, in writing, of defective areas requiring replacement, and that the substrate is acceptable for the new roofing system.

3.2 REMOVAL OF THE EXISTING ROOFING MATERIAL

- .1 Contractor to note the existing roofing material is BUR system including membrane, insulation and ballast on roof deck.
- .2 Remove the existing roofing down to existing roof deck. Take care when removing this material. Intent is not to damage the existing deck.
- .3 Contractor only to remove enough section of the existing that can be recovered with new in one day. At the end of each working day, ensure the existing/new junction is made watertight.
- .4 Ensure all removal material is properly placed in on-site refuse containers, and removed from site on a daily basis. Location of the onsite refuse container to be determined by the Project Manager. Contractor to provide off-site disposal area that is acceptable to the authority having jurisdiction.
- .5 Contractor to ensure any asphaltic cutback from the existing vapour barrier is removed from the wood deck.
- .6 Contractor to provide protection to all interior areas below the roof being modified. Ensure dust and dirt is contained and removed from site.
- .7 Contractor to confirm if repairs are required to the wood deck, refer to unit pricing paragraph 1.4.

3.3 PREPARATION OF SUBSTRATE

- .1 Prior to installation of roof system verify:
 - .1 Decks are firm, straight, smooth, dry, free of snow, ice or frost, and swept clean of dust, debris and ready for primer.
 - .2 Curb upstands have been installed for mechanical services requiring curbs, supports etc.
 - .3 Roof drains have been installed at proper elevations relative to finished roof surface.
-

3.4 INTERFACE WITH OTHER SYSTEMS

- .1 Coordinate roof systems with Section 07 62 00 Sheet Metal Flashing and Trim.
- .2 Coordinate the installation of roof drains supplied by Mechanical Components.
- .3 Provide temporary weathertight cover over mechanical upstand curbs.
- .4 Coordinate the installation of the roof mounted equipment and roof curbs by other trades for support and fastening.

3.5 INSTALLATION

- .1 Underlayment Board Installation:
 - .1 Mechanically fasten the underlayment board to the roof deck with adequate fastening for temporary securement. Final securement is to be provided by the mechanical fastening of the layers above.
 - .2 Air Vapour Barrier Installation:
 - .1 Apply the self-adhering air vapour barrier membrane to the underlayment board in accordance with manufacturer's recommendations.
 - .2 Prime the underlayment board and install self-adhered vapour barrier to the underlayment board.
 - .3 Temperature is to be above 5°C when applying the membrane.
 - .4 Apply the air/vapour barrier in direction of slope or perpendicular to slope. When applied perpendicular to slope, apply beginning at low point of and proceed in "shingle fashion". Position sheet to achieve correct overlap and alignment.
 - .5 Verify there are no air bubbles or fish mouths in the application.
 - .6 Tie-ins to other wall areas of the building envelope are to be properly tied in to form a complete and continuous air/vapour enclosure, roof and wall conditions.
 - .3 Insulation Panel Installation:
 - .1 Ensure the insulation panels are tightly fitted together.
 - .2 Discard broken insulation boards.
 - .3 Voids are to be completely filled with insulation.
 - .4 Install insulation to fit tightly next to curbs, parapets and roof protrusions.
 - .4 Overlayment Board Installation:
 - .1 Where two layers of underlayment board are used, mechanically fasten the first layer of overlayment board over the insulation panels, through rigid insulation panel to the roof deck to requirements of FM Class 1-90. Fasteners to be a minimum of 6" (150 mm) from the board edge. Stagger joints of two layers of protection board to fully protect insulation panels.
 - .2 Fasteners and fastening pattern to agree with the approved shop drawings for this project.
-

- .3 Fastener length should reflect the thickness of the insulation and the protection board. Contractor to review the location of conduit mounted to the underside of the steel deck, and verify that fasteners bypass the conduit. Contractor to repair damage or disruption to the cable/conduit under this contract.
- .4 Adhere top layer of protection board in accordance with the manufacturer's instructions with overlapping joints of the protection board installed prior.
- .5 If an overlayment board with integral base is used it is to be installed using a cold adhered process. No mechanical fastening will be permitted.

- .5 Base Sheet and Flashing Installation:
 - .1 Base sheet membrane to be fully adhered over protection board with cold process adhesive ensuring joints terminations are fully buttered. Each strip to have 3" (75mm) side laps and 6" (150mm) end laps.
 - .2 Base sheet to be re-rolled from both ends.
 - .3 Adhere the base sheet flashing after primer application is fully dried.
 - .4 Application to provide a smooth surface, free of air pockets, wrinkles, fishmouths or tears.
 - .5 Apply membrane perpendicular to slopes for roofs of less than 1:12 slope. Apply membrane parallel to slope on roofs of 1:12 or greater.
 - .6 Apply self-adhesive membrane for flashing and penetrations.

- .6 Cap Sheet Installation:
 - .1 Once the base sheet and stripping has been applied and does not show defects, the cap sheet can be laid.
 - .2 Cap sheet to be unrolled starting from the low point of the roof. Cap sheet to be rerolled from both ends prior to torching. Care must be taken for good alignment of the first roll (parallel with the edge of the roof).
 - .3 Cap sheet to be torch welded on to the base sheet membrane, in accordance with recommendations of the membrane manufacturer. During this application, both surfaces to be simultaneously melted, forming an asphalt bead, pushed out in front of the cap sheet. While the membrane is still hot, apply enough pressure with a steel roller onto the side lap so as to have bitumen seep out to create a continuous bead of bitumen on the side lap. Care should be taken not to embed the granules into the bitumen.
 - .4 Care must be taken not to burn the membranes, and their respective reinforcements.
 - .5 Base sheet and cap sheet seams to be staggered a minimum of 1'-0" (300 mm).
 - .6 Cap sheet to have side laps of 3" (75 mm) and end laps of 6" (150 mm). Surface granules on end laps to be embedded prior to installation of following sheet.
 - .7 Make sure the two membranes are properly welded, without air pockets, wrinkles, fishmouths or tears.
 - .8 After installation of the cap sheet, check lap seams on the cap sheet.
 - .9 During installation, care must be taken to avoid asphalt seepage greater than 1/5" (5 mm) at seams.

3.6 PROTECTION DURING WORK

- .1 Cover walls and adjacent work where materials hoisted or used.
-

- .2 Use warning signs and barriers. Maintain in good order until completion of work.
- .3 Clean off drips and smears of bituminous material immediately.
- .4 Dispose of rain water off roof and away from face of building until roof drains are installed and connected.
- .5 Protect roof from traffic and damage. Comply with precautions deemed necessary by Consultant.
- .6 At end of each day's work or when stoppage occurs due to inclement weather, provide protection for completed work and materials out of storage.
- .7 Place plywood runways over work to enable movement of materials and other traffic.
- .8 Contractor to ensure only as much of the roofing material removed from the roof as can be made watertight and secure by days end.
- .9 Contractor is solely responsible for water damage, to the interior of the building caused by lack of protection of the system during the deconstruction or construction of this roofing system.

3.7 PROTECTION AFTER WORK COMPLETED

- .1 Contractor to repair damage caused by work of this contract - to adjacent roof and wall areas, and also to site areas such as lawns or paved areas that have damage caused by this contract.
- .2 Contractor responsible to protect and cover interior areas for dust cover and migration of dirt stemming from work above.

3.8 CLEANING

- .1 Contractor to provide clean-up for this roofing area. Debris and excess roofing items to be removed from the site.

END

The Executed Standard Agreement of the Halifax Regional School Board is to be read in conjunction with this Section.

PART 1 GENERAL

1.1 SUMMARY OF SECTION

- .1 As summarized and described but not restricted to the following:
 - .1 To remove all flashings at the perimeter of the building and all equipment bases.
 - .2 To provide new metal flashings at the reinstated roof equipment.
 - .3 To provide metal flashing around perimeter of roof area.

1.2 REFERENCES

- .1 The standards listed form part of this Specification to the extent of reference. The publications are in the text by the basic designation only.
- .2 American Society for Testing and Materials International (ASTM):
 - .1 ASTM A653/A653M-13, Specification for Steel Sheet, Zinc-Coated (Galvanized) or Zinc-Iron Alloy Coated (Galvannealed) by the Hot-Dip Process.
 - .2 ASTM D523-14, Test Method for Specular Gloss
 - .3 ASTM D822/D822M-13, Practice for Filtered Open Flame Carbon Arc Exposures of Paint and Related Coatings
 - .4 ASTM F1667-11a e1, Driven Fasteners: Nails, Spikes and Staples
 - .5 ASTM D4586/D4586M-07(2012)e1, Standard Specification for Asphalt Roof Cement, Asbestos-Free
- .3 Canadian General Standards Board:
 - .1 CAN/CGSB 51.32-M77 Sheathing, Membrane, Breather Type

1.3 SUBMITTALS

- .1 Samples:
 - .1 Submit duplicate 50 x 50 mm samples of each type of sheet metal material, colour and finish.

1.4 ENVIRONMENTAL REQUIREMENTS

- .1 Comply with requirements of Workplace Hazardous Materials Information System (WHMIS) regarding use, handling, storage and disposal of materials.

1.5 WASTE MANAGEMENT

- .1 Separate and recycle waste materials in accordance with Division 01 Requirements.
-

1.6 DELIVERY, STORAGE AND PROTECTION OF PRODUCT

- .1 Comply with manufacturer's recommendations for handling, storage and protection during installation.
- .2 Protect and store materials off the ground, away from physical damage and from becoming wet, soiled or covered with ice or snow before, during and after installation.
- .3 Label packages to include material name, production date and/or product code.

PART 2 - PRODUCTS

2.1 MATERIALS

- .1 Prefinished Steel Sheet Flashing
 - .1 Prefinished steel, with factory applied silicone modified polyester.
 - .1 To ASTM A653/A653M Z275 zinc coating designation; 22 gauge core steel. Shop pre-coated with modified silicone.
 - .2 Class F1S.
 - .3 Specular gloss: 30 units +/- 5 in accordance with ASTM D 523
 - .4 Resistance to accelerated weathering for chalk rating of 8, colour fade 5 units, or less erosion rate less than 20% for ASTM D822
 - .1 Outdoor exposure 1000 hrs
 - .2 Humidity resistance 1000 hrs
 - .5 Ensure minimum 2" vertical leg on sheet metal flashing
 - .2 Brake Form Aluminum Flashing
 - .1 Brake form on site to cover the existing fascia, 20g. Ensure all fasteners are hidden.

2.2 ACCESSORIES

- .1 Isolation coating: alkali resistant bituminous paint.
 - .2 Plastic cement: to ASTM D4586 Type I.
 - .3 Underlay for metal flashing: dry sheathing to CAN/CGSB-51.32.
 - .4 Cleats: of same material as flashing specified, and temper as sheet metal, minimum 2" wide. Thickness 22 gauge.
 - .5 Fasteners: of same material as sheet metal, to ASTM F1667, ring thread flat head roofing nails of length and thickness suitable for metal flashing application.
 - .6 Washers: of same material as sheet metal, with rubber packings.
-

2.3 FABRICATION

- .1 Fabricate metal flashings and other sheet metal work in accordance with applicable CRCA 'FL' series details as indicated.
- .2 Form pieces in 8'-0" maximum lengths. Make allowance for expansion at joints.
- .3 Hem exposed edges on underside 1/2". Miter and seal corners with sealant.
- .4 Form sections square, true and accurate to size, free from distortion and other defects detrimental to appearance or performance.
- .5 Apply isolation coating to metal surfaces to be embedded in concrete.

PART 3 - EXECUTION

3.1 INSTALLATION

- .1 Use concealed fastenings except where approved before installation, fasteners installed at 2'-0" o.c.
- .2 Provide underlay under sheet metal. Secure in place and lap joints 4".
- .3 Counterflash bituminous flashings at intersections of roof with vertical surfaces and curbs. Flash joints using S-lock forming tight fit over hook strips.
- .4 Lock end joints and caulk with sealant.
- .5 Install surface mounted reglets true and level, and caulk top of reglet with sealant.
- .6 Insert metal flashing into reglets under cap flashing to form weathertight junction.
- .7 Caulk flashing at reglet cap flashing with sealant.
- .8 Cut triangle on diagonal joint to minimize cut joint.

END

The Executed Agreement of the Halifax Regional School Board is to be read in conjunction with this Section.

PART 1 – GENERAL

1.1 REFERENCES

- .1 American Society for Testing and Materials (ASTM)
 - .1 ASTM B32-2008, Specification for Solder Metal.
 - .2 ASTM B306-13, Specification for Copper Drainage Tube (DWV).
 - .3 ASTM C564-14, Specification for Rubber Gaskets for Cast Iron Soil Pipe and Fittings.
 - .4 ASTM B209M-10, Specification for Aluminum and Aluminum Alloy Sheet and Plate Metric.
 - .5 ASTM C335/C335M-10e1, Test Method for Steady State Heat Transfer Properties of Horizontal Pipe Insulation
 - .6 ASTM C449-07(2013), Standard Specification for Mineral Fibre Hydraulic Setting Thermal Insulating and Finishing Cement.
 - .7 ASTM C533-13, Standard specification for Calcium Silicate Insulation Block and Pipe.
 - .8 ASTM C534/C534M-13, Standard Specification for Preformed Elastomeric Cellular Thermal Insulation in Sheet And Tubular Form.
 - .9 ASTM C547-12, Standard Specification for Mineral Fibre Pipe Insulation.
 - .10 ASTM C921-10, Practice for Determining the Properties of Jacketing Materials for Thermal Insulation.
 - .2 Canadian General Standards Board (CGSB)
 - .1 CGSB 51GP52Ma, Vapour Barrier, Jacket and Facing Material for Pipe, Duct and Equipment Thermal Insulation.
 - .2 CAN/CGSB51.53, Poly (Vinyl Chloride) Jacketing Sheet, for Insulated Pipes, Vessels and Round Ducts.
 - .3 Manufacturer's Trade Associations
 - .1 Thermal Insulation Association of Canada (TIAC): National Insulation Standards.
 - .4 Underwriters' Laboratories of Canada (ULC)
 - .1 CAN/ULCS102-10, Surface Burning Characteristics of Building Materials and Assemblies.
 - .2 CAN/ULCS701-11 Thermal Insulation, Polystyrene, Boards and Pipe Covering.
 - .3 CAN/ULCS702-09, Thermal Insulation, Mineral Fibre, for Buildings
 - .5 Canadian Standards Association (CSA)
 - .1 CAN/CSA B70-12, Cast Iron Soil Pipe, Fittings and Means of Joining.
 - .2 CAN/CSA B125.3-12, Plumbing Fittings.
-

1.2 QUALIFICATIONS

- .1 Installer to be specialist in performing work of this Section, and have at least five (5) years successful experience in this size and type of project, qualified to standards of TIAC.

1.3 DELIVERY, STORAGE AND HANDLING

- .1 Deliver materials to site in original factory packaging, labelled with manufacturer's name, address.
- .2 Protect from weather, construction traffic.
- .3 Protect against damage from any source.
- .4 Store at temperatures and conditions required by manufacturer.

PART 2 – PRODUCTS

2.1 ROOF DRAIN

- .1 Standard of Acceptance: based on Zurn ZA100 15" (381mm) diameter roof drain, or approved alternate.
 - .1 Cast iron body with combination membrane flashing clamp/gravel guard.
 - .2 Under-deck clamps.
 - .3 Aluminum Dome.
 - .4 4" (100mm) Outlet.

2.2 CAST IRON PIPING AND FITTINGS: FOR INTERIOR WORK

- .1 Above ground sanitary storm and vent: to CAN/CSA B70.
 - .1 Mechanical joints: Neoprene or butyl rubber compression gaskets with stainless steel clamps.

2.3 THERMAL INSULATION FOR PIPING

- .1 Fire and smoke rating:
 - .1 In accordance with CAN/ULCS102.
 - .1 Maximum flame spread rating: 25.
 - .2 Maximum smoke developed rating: 50.
-

- .2 Insulation:
 - .1 Mineral fibre specified includes glass fibre, rock wool, slag wool.
 - .2 Thermal conductivity ("k" factor) not to exceed specified values at 24 C mean temperature when tested in accordance with ASTM C335.
 - .3 TIAC Code A3: Rigid moulded mineral fibre with factory applied vapour retarder jacket.
 - .1 Mineral fibre: to CAN/ULC S702 and ASTM C547.
 - .2 Jacket: to CGSB 51GP52Ma.
 - .3 Maximum "k" factor: to CAN/ULC S702.
 - .4 TIAC Code C2: Mineral fibre blanket faced with factory applied vapour retarder jacket (as scheduled in PART 3 of this section).
 - .1 Mineral fibre: to CAN/ULCS702.
 - .2 Jacket: to CGSB 51GP52Ma.
 - .3 Maximum "k" factor: to CAN/ULC S702.
 - .5 TIAC Code A6: flexible unicellular tubular elastomer.
 - .1 Insulation: with vapour retarder jacket to ASTM C534.
 - .2 Jacket: to CGSB 51GP52Ma.
 - .3 Maximum "k" factor: 0.039 W/mC.
 - .4 To be certified by manufacturer to be free of potential stress, corrosion, and/or cracking.
 - .5 Flame spread index less than 25 and smoke developed index less than 50.
 - .6 Acceptable Manufacturers: Manson, Knauf, Owens Corning.
- .3 Insulation Securement:
 - .1 Tape: Self-adhesive, aluminum, plain reinforced, 50 mm wide minimum.
 - .2 Contact adhesive: Quick setting.
 - .3 Canvas adhesive: Washable.
 - .4 Tie wire: 1.5 mm diameter stainless steel.
 - .5 Bands: Stainless steel, 19 mm wide, 0.5 mm thick.
- .4 Thermal insulating and finishing cement:
 - .1 Hydraulic setting or air drying on mineral wool, to ASTM C449/C449M.
- .5 Vapour Retarder Lap Adhesive:
 - .1 Water based, fire retardant type, compatible with insulation.
- .6 Indoor Vapour Retarder Finish:
 - .1 Vinyl emulsion type acrylic, compatible with insulation.
 - .2 For Type A6 insulation to manufacturer's recommendation.
- .8 Jackets:
 - .1 Canvas:
 - .1 220gm/m² cotton, plain weave, treated with dilute fire retardant lagging adhesive to ASTM C921.
 - .2 Lagging adhesive: Compatible with insulation.
 - .2 Aluminum:
 - .1 To ASTM B209.
 - .2 Thickness: 0.40 mm sheet.
 - .3 Finish: Stucco embossed or corrugated.
 - .4 Joining: Longitudinal and circumferential slip joints with 50 mm laps.

- .5 Fittings: 0.5 mm thick die shaped fitting covers with factory attached protective liner.
- .6 Metal jacket banding and mechanical seals: stainless steel, 19 mm wide, 0.5 mm thick at 300 mm spacing.
- .3 Self-adhesive Weather Barrier Membrane:
 - .1 Flexible SBS modified membrane impermeable to air, moisture vapour and water. UV light resistant, flame free adhesion.
 - .2 Henry Bakor Foilskin, or approved equivalent.

PART 3 - EXECUTION

3.1 PIPE INSTALLATION

- .1 Install in accordance with Canadian Plumbing Code and local authority having jurisdiction.
- .2 Install piping parallel and close to walls to conserve headroom and space, and grade as indicated.
- .3 Provide pipe firestop barriers and/or collars on the underside of fire-rated floors and both sides of fire-rated partitions that are penetrated.
 - .1 Acceptable Manufacturer: 3M Firestop.

3.2 PERFORMANCE VERIFICATION

- .1 Storm Water Drainage:
 - .1 Verify domes are secure.
 - .2 Confirm weirs are correctly sized and installed correctly.
 - .3 Verify provisions for movement of roof system.
 - .4 Confirm fixtures are properly anchored, connected to system and effectively vented.
 - .5 Affix applicable label (storm, sanitary, vent, pump discharge etc.) complete with directional arrows every floor or 4.5 m (whichever is less).
- .2 Pressure testing of piping systems and adjacent equipment to be complete, witnessed and certified.
- .3 Surfaces clean, dry, and free from foreign material.

3.3 INSULATION INSTALLATION

- .1 Install in accordance with TIAC National Standards.
 - .2 Apply materials in accordance with manufacturer's instructions and this specification.
-

- .3 Use two (2) layers with staggered joints when required nominal wall thickness exceeds 75 mm.
- .4 Maintain uninterrupted continuity and integrity of vapour retarder jacket and finishes.
 - .1 Hangers, supports to be outside vapour retarder jacket.
- .5 Supports, Hangers:
 - .1 Apply high compressive strength insulation, suitable for service, at oversized saddles and shoes where insulation saddles have not been provided.

3.4 REMOVABLE, PRE-FABRICATED INSULATION AND ENCLOSURES

- .1 Application: At expansion joints, valves, primary flow measuring elements flanges and unions at equipment.
- .2 Design: To permit movement of expansion joint and to permit periodic removal and replacement without damage to adjacent insulation.
- .3 Insulation:
 - .1 Insulation, fastenings and finishes: same as system.
 - .2 Jacket: Aluminum, PVC high temperature fabric.

3.5 INSTALLATION OF ELASTOMERIC INSULATION

- .1 Insulation to remain dry at all times. Overlaps to manufacturer's instructions. Ensure tight joints.
- .2 Provide vapour retarder as recommended by manufacturer.

END

The Executed Agreement of the Halifax Regional School Board is to be read in conjunction with this Section.

PART 1 - GENERAL

1.1 SUMMARY OF SECTION

- .1 As summarized and described but not restricted to the following:
 - .1 Provide rough carpentry for work from other sections as noted.
 - .2 Provide rough carpentry work as indicated in Schedule.

1.2 REFERENCES

- .1 The standards listed form part of this Specification to the extent of reference. The publications are in the text by the basic designation only.
- .2 American Society for Testing and Materials International (ASTM):
 - .1 ASTM A123/123M-13 Standard Specification for Zinc (Hot Dipped Galvanized) Coatings on Iron and Steel Products.
 - .2 ASTM F1667 -11ae1, Standard Specification for Driven Fasteners: Nails, Spikes, and Staples.
 - .3 ASTM A653/A653M-13, Standard Specification for Steel Sheet, Zinc-Coated (Galvanized) or Zinc-Iron Alloy-Coated (Galvannealed) by the Hot-Dip Process for G-185 fasteners for use with ACQ wood
- .3 American Wood Protection Association (AWPA), Alkaline Copper Quarternary (ACQ) for all pressure treated wood.
- .4 Canadian Standards Association (CSA):
 - .1 CSA-B111-1974 (R2003), Wire Nails, Spikes and Staples.
 - .2 CAN/CSA-G164-M92 (R2003), Hot Dip Galvanizing of Irregularly Shaped Articles.
 - .3 CSA O80S2-05 Supplement to O80 Series-97, Wood Preservation
 - .4 CSA O151-09(R2014), Canadian Softwood Plywood.
- .5 ISO 14040:2006, Environmental management, Life Cycle Assessment, Principles and Framework.
- .6 National Building Code of Canada (NBCC) 2010.
- .7 National Lumber Grades Authority (NLGA), Standard Grading Rules for Canadian Lumber, 2010.

1.3 ENVIRONMENTAL REQUIREMENTS

- .1 Comply with requirements of Workplace Hazardous Materials Information System (WHMIS) regarding use, handling, storage and disposal of materials.
-

1.4 WASTE MANAGEMENT

- .1 Separate and recycle waste materials in accordance with Division 01 Requirements.
- .2 Separate wood waste and place in designated areas in the following categories for recycling: Solid wood/ softwood/ hardwood, composite wood, treated, painted, or contaminated wood in containers supplied by the Contractor.
- .3 Set aside damaged wood and dimensional lumber off-cuts for acceptable alternative uses (e.g. bracing, blocking, cripples, bridging, finger-joining, or ties). Store this separated reusable wood waste convenient to cutting station and area of work.
- .4 Do not burn scrap at the project site.
- .5 Separate corrugated cardboard and recycle.

1.5 DELIVERY, STORAGE AND PROTECTION OF PRODUCT

- .1 Deliver and store materials in compliance with Division 01 Requirements.
- .2 Comply with manufacturer's recommendations for handling, storage and protection during installation.
- .3 Protect and store materials off the ground, away from physical damage and from becoming wet, soiled or covered with ice or snow before, during and after installation.
- .4 Label packages to include material name, production date and/or product code.

1.6 QUALITY ASSURANCE/QUALITY CONTROL

- .1 Lumber identification: by grade stamp of an agency certified by Canadian Lumber Standards Accreditation Board.
- .2 Plywood identification: by grade mark in accordance with applicable CSA standards.

PART 2 - PRODUCTS

2.1 LUMBER MATERIAL

- .1 Softwood Lumber: unless specified otherwise:
 - .1 Softwood, SPF Species, NLGA Grade 2 (or better).
 - .2 G4S, (good four sides)
 - .3 Moisture content 19% or less in accordance with:
 - .1 CSA-O141
 - .2 NLGA Standard Grading Rules for Canadian Lumber

- .2 Furring, blocking, nailing strips: cants, curbs, backing and sleepers:
 - .1 Softwood, SPF series, NLGA Standard or better grade.
 - .2 Moisture content: 19% or less, in accordance with:
 - .1 CSA-O141
 - .2 NLGA Standard Grading Rules for Canadian Lumber.
- .3 The manufacturing process must adhere to Lifecycle Assessment (LCA) standards as per ISO 14040.
- .4 Use pressure treated lumber for all roof related items and when wood is in contact with concrete.
 - .1 Pressure treated wood (Alkaline Copper Quarternary) treatment in accordance with CSA-O80 Series

2.2 SOFT WOOD PANEL MATERIALS

- .1 Canadian Softwood Plywood: to CSA O151, standard construction.
- .2 Use pressure treated panels for all roof related items and when wood is in contact with concrete.
 - .1 Pressure treated wood (Alkaline Copper Quarternary) treatment in accordance with CSA-O80 Series.

2.3 FASTENERS

- .1 Nails, spikes and staples: to CSA B111 and ASTM F1667.
- .2 Bolts: 1/2" min. diameter unless indicated otherwise, complete with nuts and washers.
- .3 Proprietary fasteners: toggle bolts, expansion shields and lag bolts, screws and lead or inorganic fiber plugs, explosive actuated fastening devices, recommended for purpose by manufacturer.
- .4 Fasteners for ACQ wood must be galvanized to G-185 (as defined in ASTM A653/A653M) or better, stainless steel or ceramic coated fasteners approved for use with ACQ wood.

2.4 SEMI-RIGID INSULATION

- .1 Semi-Rigid Fibrous Insulation:
 - .1 Standard of Acceptance: specification based on Roxul Inc Semi-Rigid board, or approved alternate.
 - .2 Board Density: ASTM C612, 4.4 lbs/ft³ or 70 kg/m³
 - .3 Board Size: 16" (406 mm) OR 24" (610 mm) wide by 48" (1219 mm) long.
 - .4 Board Thickness: 1" (25 mm), OR 1.5" (38 mm), 2" (50 mm)
 - .5 Facing: unfaced
 - .6 Non-Combustable: ASTM E136, CAN/ULC S114
-

- .7 Thermal Resistance: R-Value 4.2 per inch. RSI-Value: 0.74m² k/w
- .8 Moisture Resistance: ASTM C1104, Moisture Absorption: 0.03% volume
- .9 Water Vapour Permeance: ASTM E96 (33.1 perm)
- .10 Acceptable Alternate Manufacturers:
 - .1 Thermafibre Inc.

PART 3 - EXECUTION

3.1 EXAMINATION

- .1 Verify that field conditions are acceptable and are ready to receive Work.
- .2 Site verify dimensions, tolerances and method of attachment with other Work.

3.2 INSTALLATION

- .1 Comply with requirements of NBC 2010.
- .2 Install rough bucks, nailers and linings to rough openings as required to provide backing for frames and other work.
- .3 Install sleepers as indicated.
- .4 Provide space framing and furring as indicated.
- .5 Align and plumb faces of furring and blocking to tolerance of 1:600.
- .6 Install backing, nailers, curbs and other wood supports as required, secure using ACQ approved fasteners at exterior locations.
- .7 Frame, anchor, fasten, tie and brace members to provide necessary strength and rigidity.
- .8 Countersink bolts where necessary to provide clearance for other work.

3.3 SCHEDULE

- .1 Roof Curbs for Parapets and Mechanical Equipment:
 - .1 Construction & Anchorage:
 - .1 PT 2x4 wood studs at 16" o.c.
 - .2 ½" pressure treated plywood, both sides mechanically fastened at 6" o.c.
 - .3 Semi Rigid Batt Insulation; Standard of Acceptance Roxul or Thermafibre or accepted alternate
 - .4 Refer to details for height of curb and extent.
 - .5 Ensure curb is leveled around perimeter.
 - .2 Optional Assembly: Solid wood curb constructed of built-up layers of PT wood.

- .2 Roof Curbs for Chimneys:
 - .1 Construction & Anchorage:
 - .1 6" steel studs at 16" o.c.
 - .2 ½" overlayment board, both sides mechanically fastened at 6" o.c.
 - .3 Semi Rigid Batt Insulation; Standard of Acceptance Roxul or Thermafibre or accepted alternate
 - .4 Refer to details for height and extent of chimney surround.
 - .5 Ensure curb is leveled around perimeter.

3.4 CLEANING

- .1 Perform cleaning as soon as possible after installation to remove construction and accumulated environmental dirt.
- .2 Upon completion of installation, remove surplus materials, rubbish, tools and equipment barriers.

END

The Executed Agreement of the Halifax Regional School Board is to be read in conjunction with this Section.

PART 1 - GENERAL

1.1 SUMMARY OF SECTION

- .1 As summarized and described herein, but not restricted to the following:
 - .1 Remove the existing ballasted EPDM roofing system, flashing, insulation, vapour barrier, down to the existing metal deck as noted on the drawings.
 - .2 Provide new two-ply modified bituminous membrane roofing system as noted on drawings with provision for FM Class 1-90 wind uplift standards.
 - .3 To temporarily remove mechanical exhaust fans, and provide new curbs and upstand, provide metal duct extensions, and replace once roofing and flashing is in place.
 - .4 Provide all built-up parapets, blocking curb extensions as required.
 - .5 Provide new roof flashing tie-ins to existing wall systems.
 - .6 To provide fit-ups to roof deck if uncovered and has deteriorated, as a Unit Price. Refer to paragraph 1.4 of this section and Tender/Bid Document for additional information.

1.2 ACCEPTABLE ROOFING ASSEMBLIES

- .1 The following assemblies are acceptable for use on this project. Materials are listed in Part 2. Alternate assemblies will only be considered during the bidding phase.
 - .1 Roof Assembly option 'A'
 - .1 Existing roof deck to remain.
 - .2 ½" Underlayment Board
 - .3 Vapour Barrier
 - .4 Expanded Polystyrene Rigid Insulation
 - .5 ½" Overlayment Board – mechanically fastened to 1-90
 - .6 ½" Overlayment Board – cold adhered
 - .7 Modified Bitumen Base – cold adhered
 - .8 Modified Bitumen Cap – torch applied
 - .2 Roof Assembly option 'B'
 - .1 Existing roof deck to remain.
 - .2 ½" Underlayment Board
 - .3 Vapour Barrier
 - .4 Expanded Polystyrene Rigid Insulation
 - .5 ½" Overlayment Board – mechanically fastened to 1-90
 - .6 ½" Overlayment Board with Modified Bitumen Base – cold adhered
 - .7 Modified Bitumen Cap – torch applied
-

- .3 Roof Assembly option 'C'
 - .1 Existing roof deck to remain.
 - .2 ½" Underlayment Board
 - .3 Vapour Barrier
 - .4 Polyisocyanurate Rigid Insulation– mechanically fastened to 1-90
 - .5 ½" Overlayment Board – cold adhered
 - .6 Modified Bitumen Base – cold adhered
 - .7 Modified Bitumen Cap – torch applied

- .4 Roof Assembly option 'D'
 - .1 Existing roof deck to remain.
 - .2 ½" Underlayment Board
 - .3 Vapour Barrier
 - .4 Polyisocyanurate Rigid Insulation– mechanically fastened to 1-90
 - .5 ½" Overlayment Board with Modified Bitumen Base – cold adhered
 - .6 Modified Bitumen Cap – torch applied

1.3 REFERENCES

- .1 American National Standards Institute (ANSI) Factory Mutual (FM):
 - .1 ANSI/FM Approval 4474, Evaluating the Simulated Wind Uplift Resistance of Roof Assemblies Using Static Positive and/or Negative Differential Pressures (Class range from 1-60 to 1-990).

 - .2 American Society for Testing and Materials International (ASTM):
 - .1 ASTM C208-12, Specification for Cellulosic Fiber Insulating Board.
 - .2 ASTM C578-12b, Specification for Rigid, Cellular Polystyrene Thermal Insulation.
 - .3 ASTM C1177/C1177M-13, Glass Mat Gypsum Substrate for Use as Sheathing
 - .4 ASTM D6164/D6164M-11, Styrene Butadiene Styrene (SBS) Modified Bituminous Sheet Materials Using Polyester Reinforcements.
 - .5 ASTM D4586/D4586M-07(2012)e1, Asphalt Roof Cement, Asbestos Free

 - ..3 Canadian General Standards Board:
 - .1 CGSB 37-GP-9Ma, Primer, Asphalt, Unfilled, for Asphalt Roofing, Dampproofing and Waterproofing.

 - .4 Canadian Roofing Contractors' Association (CRCA) – Roofing Specifications Manual.

 - .5 Nova Scotia Construction Safety Association (NSCSA), Occupational Health and Safety Act (OHSA)

 - .6 Underwriters Laboratories of Canada (ULC):
 - .1 CAN/ULC S701-11 EN, Standard for Thermal Insulation, Polystyrene, Boards and Pipe Covering.
-

1.4 UNIT PRICES

- .1 Refer to the Tender/Bid Documents for Unit Prices:
 - .1 Unit Price #1: Provide a Unit Price for the replacement of the existing roof decking.
 - .2 Unit Price #2: Provide a Unit Price for the replacement of the existing wood blocking, parapets, and/or curbs that are noted to remain, but that may contain rot and/or damage, if deemed unusable.

1.5 SUBMITTALS

- .1 Provide shop drawings including manufacturers technical data sheets and installation methods for each component. Include a summary of the roofing system from top to bottom.
 - .1 Ensure manufacturer products specified are as prescribed by FM Class 1-90 wind uplift recommendations.
 - .2 Provide layout for tapered areas of rigid insulation. Ensure tapered insulation noted for roof areas indicate a positive slope to drain.
 - .3 Provide fastening layouts meeting FM Class 1-90 requirements, for field, edge and corner locations.

1.6 ENVIRONMENTAL REQUIREMENTS

- .1 Comply with requirements of Workplace Hazardous Materials Information System (WHMIS) regarding use, handling, storage and disposal of materials.
- .2 Refer to the Manufacturer's recommendations regarding installation of roofing system at ambient temperatures. Roofing system should be applied when temperatures are above 0°C.
- .3 Refer to the Manufacturer's recommendations of temperatures required for conditioning the materials prior to application and install and curing after.
- .4 Install roofing on dry deck, free of snow and ice, use only dry materials and apply only during weather that will not introduce moisture into roofing system.
- .5 Only 'Dry' materials are to be installed. Materials that are installed wet, or materials that become wet during inclement weather to be removed and replaced.

1.7 SAFETY REQUIREMENTS

- .1 Refer to the HRSB Documents on Safety.
 - .2 Contractor to abide by NSCSA Occupational Health and Safety Act.
-

- .3 Ensure all roof installers have taken the NSCSA Fall Protection course and abide by the NSCSA Fall Protection Course Guidelines.
- .4 Contractor to be cognizant of proper protection of removal of roofing from the building and site. Ensure Project Manager is advised re the proposed location and protection.

1.8 WASTE MANAGEMENT

- .1 Contractor to remove debris immediately from site to a designated landfill approved by Provincial Regulations to accept existing roofing materials debris.

1.9 PERFORMANCE CRITERIA

- .1 Compatibility between components of roofing system is essential. Provide written declaration to Consultant stating that materials and components, as assembled in system, meet this requirement.
- .2 Do roofing work in accordance with applicable, standard in Canadian Roofing Contractors Association (CRCA) Roofing Specifications Manual and to prescribed FM Class 1-90 wind uplift requirements where mechanically fastened.

1.10 DELIVERY, STORAGE AND PROTECTION OF PRODUCT

- .1 Comply with manufacturer's recommendations for handling, storage and protection during installation.
 - .2 Protect and store materials off the ground, away from physical damage and from becoming wet, soiled or covered with ice or snow before, during and after installation.
 - .3 Removal and replacement of roof drains and removal and reinstatement of existing mechanical units to be completed by a subcontractor qualified to complete the identified work.
 - .4 Label packages to include material name, production date and/or product code.
 - .5 Store rolls of felt and membrane in upright position. Store membrane rolls with salvage edge up.
 - .6 Remove only in quantities required for same day use.
 - .7 Place plywood runways over work to enable movement of material and other traffic.
 - .8 Store roofing material at +5C minimum.
-

1.11 QUALITY ASSURANCE/QUALITY CONTROL

- .1 Convene pre-installation meeting one week prior to beginning work of this Section.
 - .1 Verify project requirements.
 - .2 Review installation and substrate conditions.
 - .3 Co-ordinate with other building subtrades.
 - .4 Review manufacturer's installation instructions and warranty requirements.
 - .5 Record meeting proceedings including corrective measures and other actions required to ensure successful completion of work and distribute to each attendee within one week of meeting.
- .2 Certificates: product certificates signed by manufacturer certifying materials comply with specified performance characteristics and criteria and physical requirements.
- .3 Roofing applicator must be a good standing member of the CRCA and approved by the Roof Manufacturing Company selected on this Project, and have completed projects of this magnitude in the last five (5) years.
- .4 Contractor to hold pre-construction meeting with Manufacturer's Technical Representative to review the substrate condition and review the process of installation. Manufacturer's Representative to visit site three (3) times unannounced during construction and once at completion and provide inspection reports to the Consultant.

1.12 FIRE WATCH

- .1 Fire Extinguishers: maintain one cartridge operated type with hose and shut-off nozzle, ULC labelled for A, B and C class protection, within 3 meters of torch applicator.
- .2 Cease torching at least three (3) hours before leaving for the day and maintain fire watch for two (2) hours after each day's roofing operations cease.
- .3 Designate a person, equipped with a fire extinguisher and a cell phone, responsible in the event of a fire, to do a mandatory walk-about to check for hot spots.
- .4 Make sure all workers know the escape route.

1.13 TEST REPORTS

- .1 If required by the Owner, provide a third party roof inspection company to check and verify all systems from Shop Drawing review, to Roof preconstruction. Meetings to review during the application of the system.
 - .2 Provide interim written reports during the application to the Consultant.
 - .3 Infrared testing of the entire roof will be required and will include all field applications. Testing of flashing: at cap flashing, roof to wall flashing, etc., and at all roof drains. Provide infrared testing of all seam testing.
-

- .4 Qualifications of the required test will be as follows:
 - .1 Upon completion of the Primary Waterproofing Membrane, Protection Course, and all associated terminations, the Contractor shall test the system.
 - .2 Repair and retest the system, report all deficiencies to the Consultant.
 - .3 No other Work is to proceed without prior direction from the Consultant.
- .5 Submit copies of all test reports to the Consultant.
- .6 All costs of the third party testing, if required, will be borne by the Owner.

1.14 WARRANTIES

- .1 Roofing Contractor to supply the Owner with a CRCA warranty certifying work completed as installed to be free of roof defect for a period of two (2) years from date of substantial performance.
- .2 Provide manufacturer's membrane warranty (non-pro-rated) in the name of the Owner, stating roofing system will remain watertight for a period of a full ten (10) years from the date of substantial completion. This warranty is to include both labour and materials necessary to affect water tightness.

PART 2 - PRODUCTS

2.1 UNDERLAYMENT BOARD

- .1 Mold and Moisture Resistant, non-combustible, solid core underlayment board to provide smooth surface for Air/Vapour Barrier application.
- .2 Manufactured as per ASTM C1177/C1177M.
- .3 Size Boards: 48" (1220 mm) wide x 96" (2440 mm) long x 1/2" (12.7mm) thick minimum.
- .4 Standard of Acceptance based on the following, or approved alternate:
 - .1 CGC Securock Glass mat Roof Board
 - .2 Georgia Pacific DensDeck Prime Roof Board.

2.2 VAPOUR BARRIER

- .1 SBS Modified bitumen, self-adhering membrane, reinforced with skid resistant polyethylene surface film.
 - .2 Self gasketing material with fully adhered system that has split release backing for fast application.
-

- .3 Suitable for application on top of roof underlayment board and serves as full coverage waterproofing layer in roof assembly.
- .4 Primer as required by manufacturer.
- .5 Thickness: 1.0 mm (40 mils)
- .6 Water Vapour Transmission: 0.05 perms
- .7 Standard of Acceptance: Blueskin PE 200 HT by Henry Company
- .8 Approved Alternates:
 - .1 IKO MVP
 - .2 Soprema Sopravap'r

2.3 EXPANDED POLYSTYRENE INSULATION

- .1 Polystyrene Insulation Type I or Type II Board manufactured to CAN/ULC-S701 and ASTM C578. Contains no CFC, HCFC or HFC blowing agents.
- .2 Size Board: 4'-0" (1220 mm) x 4'-0" (1220 mm)
- .3 Thermal Resistance: R value = R30
- .4 Tapered Insulation: where noted on the drawings.
- .5 Edges ship lapped, or insulation applied in two layers with staggered joints.

2.4 POLYISOCYANURATE RIGID INSULATION

- .1 Polyisocyanurate roof insulation Type 2 or Type 3 manufactured to CAN/ULC-S704-03 or CAN/ULC-S704-11.
 - .2 Size Board: 4'-0" (1220 mm) x 4'-0" (1220 mm) or 4'-0" (1220 mm) x 8'-0" (2440 mm)
 - .3 Physical Properties
 - .1 Compressive strength: 140kPa minimum
 - .2 Water absorption: 3.5% max (by volume)
 - .4 Thermal Resistance: R value = R30
 - .5 Mechanically fastened through deck with purpose made screws and plates. Fastening is to meet 1-90 wind uplift requirements.
 - .6 Tapered Insulation: refer to roof plans for extent and dimensions of tapered insulation.
 - .7 Edges ship lapped, or insulation applied in two layers with staggered joints
-

2.5 ROOFING ADHESIVES

- .1 Insulation and Overlayment Board Adhesive:
 - .1 Must be compatible with roofing system components, and meet roofing warranty requirements.
 - .2 Meets 1-90 wind uplift requirements.
 - .3 Low rise, low odor, foam adhesive.
 - .4 IKO Millennium or equivalent
- .2 Membrane Adhesive:
 - .1 Must be compatible with roofing system components, and meet roofing warranty requirements.
 - .2 Meets 1-90 wind uplift requirements.
 - .3 Solvent-free adhesive designed for cold application of roofing membranes.
 - .4 IKO Cold Gold adhesive or equivalent

2.6 OVERLAYMENT BOARD

- .1 Uniform, moisture resistant, fiberboard with premium wax resins to ASTM C208 high density, Type II, Grade 2.
- .2 Size boards: 4' (1220mm) x 8' (2440mm)
- .3 Thickness boards: 1/2" (13mm)
- .4 Physical Properties:
 - .1 Compressive Strength: 240 kPa min.
 - .2 Water Absorption: 7% volume max.
 - .3 Linear expansion: 0.5% max.
- .5 Acceptable Products:
 - .1 Vanguard Fiberboard High Density
 - .2 IKO Protection Board – Protectoboard
 - .3 Georgia Pacific commercial roof fiberboard
 - .4 Soprema Sopraboard
 - .5 Celotex Structodek

2.7 OVERLAYMENT BOARD WITH INTEGRAL BASE SHEET

- .1 1/2" high density fibreboard with integral 180 g/m base sheet. Top face thermofusible film for torch application of cap sheet.
 - .2 Meets CAN/ULC-S706 and ASTM C208
 - .3 Cold adhered installation only, to meet 1-90 wind uplift requirements.
-

- .4 Membrane edges self-adhesive or cold adhered.
- .5 Acceptable products: Roofcraft-180-base-f/r-polyester, Lexbase-180-fr-Polyester or approved alternate.

2.8 ROOF MEMBRANES

- .1 Base Sheet: 180 g/m:
 - .1 Non-woven reinforcing matt, polyester coated and permeated with SBS modified bitumen. This membrane is applied with cold adhesive.
 - .2 Thickness: 2.2mm (87mils)
 - .3 Bottom side coated with sand to allow adhesion with cold process adhesive.
 - .4 Top surface thermofusible film to allow adhesion with torch applied cap.
 - .5 Manufactured to ASTM D6164 for Type 1, Grade 'S' materials.
 - .6 Standard of Acceptance based on IKO MP-180-FS-Base.
 - .7 Approved Alternate Manufacturers:
 - .1 Soprema
 - .2 Bakor by Henry Company
 - .3 Polyglass
 - .2 Base Sheet Flashing 180 g/m:
 - .1 Non-woven reinforcing matt, polyester coated and permeated with Modiflex SBS bitumen, self-adhering one side, thermo fusible plastic film over.
 - .2 Thickness: 2.5mm (98mils)
 - .3 Poly Film (thermo fusible) covers the top surface; the back surface is self-adhered, silicone treated film.
 - .4 Manufactured to ASTM D6164.
 - .5 Primer as per manufacturer's recommendations.
 - .6 Standard of Acceptance based on IKO Armour Bond Flash.
 - .7 Approved Alternate Manufacturers:
 - .1 Soprema
 - .2 Bakor by Henry Company
 - .3 Polyglass
 - .3 Cap Sheet and Cap Flashing 250g/m:
 - .1 Non-woven reinforcing mat, strengthened with selected glass fibre strands, coated and permeated with SBS modified bitumen. The underside to be protected by thermofusible plastic film. Membrane to be applied by torching only.
 - .2 Thickness: 4.0mm (158mils)
 - .3 Coloured ceramic mineral granules embedded into top surface to provide protection against ultraviolet radiation.
 - .4 Manufactured to ASTM D6164 for Type II, Grade G materials.
 - .5 Standard of Acceptance based on IKO Torchflex TP 250 CAP
 - .6 Approved Alternate manufacturers:
 - .1 Soprema
 - .2 Bakor by Henry Company.
 - .3 Polyglass
-

PART 3 - EXECUTION

3.1 EXAMINATION

- .1 Manufacturer's Technical Representative to examine roof decks and immediately inform the Consultant, in writing, of defective areas requiring replacement, and that the substrate is acceptable for the new roofing system.

3.2 REMOVAL OF THE EXISTING ROOFING MATERIAL

- .1 Contractor to note the existing roofing material is a ballasted EPDM system including membrane, insulation and ballast on roof deck.
- .2 Remove the existing roofing down to existing roof deck. Take care when removing this material. Intent is not to damage the existing deck.
- .3 Contractor only to remove enough section of the existing that can be recovered with new in one day. At the end of each working day, ensure the existing/new junction is made watertight.
- .4 Ensure all removal material is properly placed in on-site refuse containers, and removed from site on a daily basis. Location of the onsite refuse container to be determined by the Project Manager. Contractor to provide off-site disposal area that is acceptable to the authority having jurisdiction.
- .5 Contractor to ensure any asphaltic cutback from the existing vapour barrier is removed from the steel deck.
- .6 Contractor to provide protection to all interior areas below the roof being modified. Ensure dust and dirt is contained and removed from site.
- .7 Contractor to confirm if repairs are required to the steel deck, refer to unit pricing paragraph 1.4.

3.3 PREPARATION OF SUBSTRATE

- .1 Prior to installation of roof system verify:
 - .1 Decks are firm, straight, smooth, dry, free of snow, ice or frost, and swept clean of dust, debris and ready for primer.
 - .2 Curb upstands have been installed for mechanical services requiring curbs, supports etc.
-

3.4 INTERFACE WITH OTHER SYSTEMS

- .1 Coordinate roof systems with Section 07 62 00 Sheet Metal Flashing and Trim.
- .2 Provide temporary weathertight cover over mechanical upstand curbs.
- .3 Coordinate the installation of the roof mounted equipment and roof curbs by other trades for support and fastening.

3.5 INSTALLATION

- .1 Underlayment Board Installation:
 - .1 Mechanically fasten the underlayment board to the roof deck with adequate fastening for temporary securement. Final securement is to be provided by the mechanical fastening of the layers above.
 - .2 Air Vapour Barrier Installation:
 - .1 Apply the self-adhering air vapour barrier membrane to the underlayment board in accordance with manufacturer's recommendations.
 - .2 Prime the underlayment board and install self-adhered vapour barrier to the underlayment board.
 - .3 Temperature is to be above 5°C when applying the membrane.
 - .4 Apply the air/vapour barrier beginning at low point of and proceed in "shingle fashion". Position sheet to achieve correct overlap and alignment.
 - .5 Verify there are no air bubbles or fish mouths in the application.
 - .6 Tie-ins to other wall areas of the building envelope are to be properly tied in to form a complete and continuous air/vapour enclosure, roof and wall conditions.
 - .3 Insulation Panel Installation:
 - .1 Ensure the insulation panels are tightly fitted together.
 - .2 Discard broken insulation boards.
 - .3 Voids are to be completely filled with insulation.
 - .4 Install insulation to fit tightly next to curbs, parapets and roof protrusions.
 - .4 Overlayment Board Installation:
 - .1 Where two layers of overlayment board are used, mechanically fasten the first layer of overlayment board over the insulation panels, through rigid insulation panel to the roof deck to requirements of FM Class 1-90. Fasteners to be a minimum of 6" (150 mm) from the board edge. Stagger joints of two layers of protection board to fully protect insulation panels.
 - .2 Fasteners and fastening pattern to agree with the approved shop drawings for this project.
 - .3 Fastener length should reflect the thickness of the insulation and the protection board. Contractor to review the location of conduit mounted to the underside of the steel deck, and verify that fasteners bypass the conduit. Contractor to repair damage or disruption to the cable/conduit under this contract.
 - .4 Adhere top layer of protection board in accordance with the manufacturer's instructions with overlapping joints of the protection board installed prior.
-

- .5 If an overlayment board with integral base is used it is to be installed using a cold adhered process. No mechanical fastening will be permitted.

- .5 Base Sheet and Flashing Installation:
 - .1 Base sheet membrane to be fully adhered over protection board with cold process adhesive ensuring joints terminations are fully buttered. Each strip to have 3” (75mm) side laps and 6” (150mm) end laps.
 - .2 Base sheet to be re-rolled from both ends.
 - .3 Adhere the base sheet flashing after primer application is fully dried.
 - .4 Application to provide a smooth surface, free of air pockets, wrinkles, fishmouths or tears.
 - .5 Apply membrane perpendicular to slopes in “shingle fashion”.
 - .6 Apply self-adhesive membrane for flashing and penetrations.

- .6 Cap Sheet Installation:
 - .1 Once the base sheet and stripping has been applied and does not show defects, the cap sheet can be laid.
 - .2 Cap sheet to be unrolled starting from the low point of the roof. Cap sheet to be rerolled from both ends prior to torching. Care must be taken for good alignment of the first roll (parallel with the edge of the roof).
 - .3 Cap sheet to be torch welded on to the base sheet membrane, in accordance with recommendations of the membrane manufacturer. During this application, both surfaces to be simultaneously melted, forming an asphalt bead, pushed out in front of the cap sheet. While the membrane is still hot, apply enough pressure with a steel roller onto the side lap so as to have bitumen seep out to create a continuous bead of bitumen on the side lap. Care should be taken not to embed the granules into the bitumen.
 - .4 Care must be taken not to burn the membranes, and their respective reinforcements.
 - .5 Base sheet and cap sheet seams to be staggered a minimum of 1’-0” (300 mm).
 - .6 Cap sheet to have side laps of 3” (75 mm) and end laps of 6” (150 mm). Surface granules on end laps to be embedded prior to installation of following sheet.
 - .7 Make sure the two membranes are properly welded, without air pockets, wrinkles, fishmouths or tears.
 - .8 After installation of the cap sheet, check lap seams on the cap sheet.
 - .9 During installation, care must be taken to avoid asphalt seepage greater than 1/5” (5 mm) at seams.

3.6 PROTECTION DURING WORK

- .1 Cover walls and adjacent work where materials hoisted or used.
 - .2 Use warning signs and barriers. Maintain in good order until completion of work.
 - .3 Clean off drips and smears of bituminous material immediately.
 - .4 Protect roof from traffic and damage. Comply with precautions deemed necessary by Consultant.
-

- .5 At end of each day's work or when stoppage occurs due to inclement weather, provide protection for completed work and materials out of storage.
- .6 Place plywood runways over work to enable movement of materials and other traffic.
- .7 Contractor to ensure only as much of the roofing material removed from the roof as can be made watertight and secure by days end.
- .8 Contractor is solely responsible for water damage, to the interior of the building caused by lack of protection of the system during the deconstruction or construction of this roofing system.

3.7 PROTECTION AFTER WORK COMPLETED

- .1 Contractor to repair damage caused by work of this contract - to adjacent roof and wall areas, and also to site areas such as lawns or paved areas that have damage caused by this contract.
- .2 Contractor responsible to protect and cover interior areas for dust cover and migration of dirt stemming from work above.

3.8 CLEANING

- .1 Contractor to provide clean-up for this roofing area. Debris and excess roofing items to be removed from the site.

END

The Executed Standard Agreement of the Halifax Regional School Board is to be read in conjunction with this Section.

PART 1 GENERAL

1.1 SUMMARY OF SECTION

- .1 As summarized and described but not restricted to the following:
 - .1 To remove all flashings at the perimeter of the building and all equipment bases.
 - .2 To provide new metal flashings at the reinstated roof equipment.
 - .3 To provide metal flashing around perimeter of roof area.

1.2 REFERENCES

- .1 The standards listed form part of this Specification to the extent of reference. The publications are in the text by the basic designation only.
- .2 American Society for Testing and Materials International (ASTM):
 - .1 ASTM A653/A653M-13, Specification for Steel Sheet, Zinc-Coated (Galvanized) or Zinc-Iron Alloy Coated (Galvannealed) by the Hot-Dip Process.
 - .2 ASTM D523-14, Test Method for Specular Gloss
 - .3 ASTM D822/D822M-13, Practice for Filtered Open Flame Carbon Arc Exposures of Paint and Related Coatings
 - .4 ASTM F1667-11a e1, Driven Fasteners: Nails, Spikes and Staples
 - .5 ASTM D4586/D4586M-07(2012)e1, Standard Specification for Asphalt Roof Cement, Asbestos-Free
- .3 Canadian General Standards Board:
 - .1 CAN/CGSB 51.32-M77 Sheathing, Membrane, Breather Type

1.3 SUBMITTALS

- .1 Samples:
 - .1 Submit duplicate 50 x 50 mm samples of each type of sheet metal material, colour and finish.

1.4 ENVIRONMENTAL REQUIREMENTS

- .1 Comply with requirements of Workplace Hazardous Materials Information System (WHMIS) regarding use, handling, storage and disposal of materials.

1.5 WASTE MANAGEMENT

- .1 Separate and recycle waste materials in accordance with Division 01 Requirements.
-

1.6 DELIVERY, STORAGE AND PROTECTION OF PRODUCT

- .1 Comply with manufacturer's recommendations for handling, storage and protection during installation.
- .2 Protect and store materials off the ground, away from physical damage and from becoming wet, soiled or covered with ice or snow before, during and after installation.
- .3 Label packages to include material name, production date and/or product code.

PART 2 - PRODUCTS

2.1 MATERIALS

- .1 Prefinished Steel Sheet Flashing
 - .1 Prefinished steel, with factory applied silicone modified polyester.
 - .1 To ASTM A653/A653M Z275 zinc coating designation; 22 gauge core steel. Shop pre-coated with modified silicone.
 - .2 Class F1S.
 - .3 Specular gloss: 30 units +/- 5 in accordance with ASTM D 523
 - .4 Resistance to accelerated weathering for chalk rating of 8, colour fade 5 units, or less erosion rate less than 20% for ASTM D822
 - .1 Outdoor exposure 1000 hrs
 - .2 Humidity resistance 1000 hrs
 - .5 Ensure minimum 2" vertical leg on sheet metal flashing
 - .2 Brake Form Aluminum Flashing
 - .1 Brake form on site to cover the new fascia, 20g. Ensure all fasteners are hidden.

2.2 ACCESSORIES

- .1 Isolation coating: alkali resistant bituminous paint.
 - .2 Plastic cement: to ASTM D4586 Type I.
 - .3 Underlay for metal flashing: dry sheathing to CAN/CGSB-51.32.
 - .4 Cleats: of same material as flashing specified, and temper as sheet metal, minimum 2" wide. Thickness 22 gauge.
 - .5 Fasteners: of same material as sheet metal, to ASTM F1667, ring thread flat head roofing nails of length and thickness suitable for metal flashing application.
 - .6 Washers: of same material as sheet metal, with rubber packings.
-

2.3 FABRICATION

- .1 Fabricate metal flashings and other sheet metal work in accordance with applicable CRCA 'FL' series details as indicated.
- .2 Form pieces in 8'-0" maximum lengths. Make allowance for expansion at joints.
- .3 Hem exposed edges on underside 1/2". Miter and seal corners with sealant.
- .4 Form sections square, true and accurate to size, free from distortion and other defects detrimental to appearance or performance.
- .5 Apply isolation coating to metal surfaces to be embedded in concrete.

PART 3 - EXECUTION

3.1 INSTALLATION

- .1 Use concealed fastenings except where approved before installation, fasteners installed at 2'-0" o.c.
- .2 Provide underlay under sheet metal. Secure in place and lap joints 4".
- .3 Counterflash bituminous flashings at intersections of roof with vertical surfaces and curbs. Flash joints using S-lock forming tight fit over hook strips.
- .4 Lock end joints and caulk with sealant.
- .5 Install surface mounted reglets true and level, and caulk top of reglet with sealant.
- .6 Insert metal flashing into reglets under cap flashing to form weathertight junction.
- .7 Caulk flashing at reglet cap flashing with sealant.
- .8 Cut triangle on diagonal joint to minimize cut joint.

END

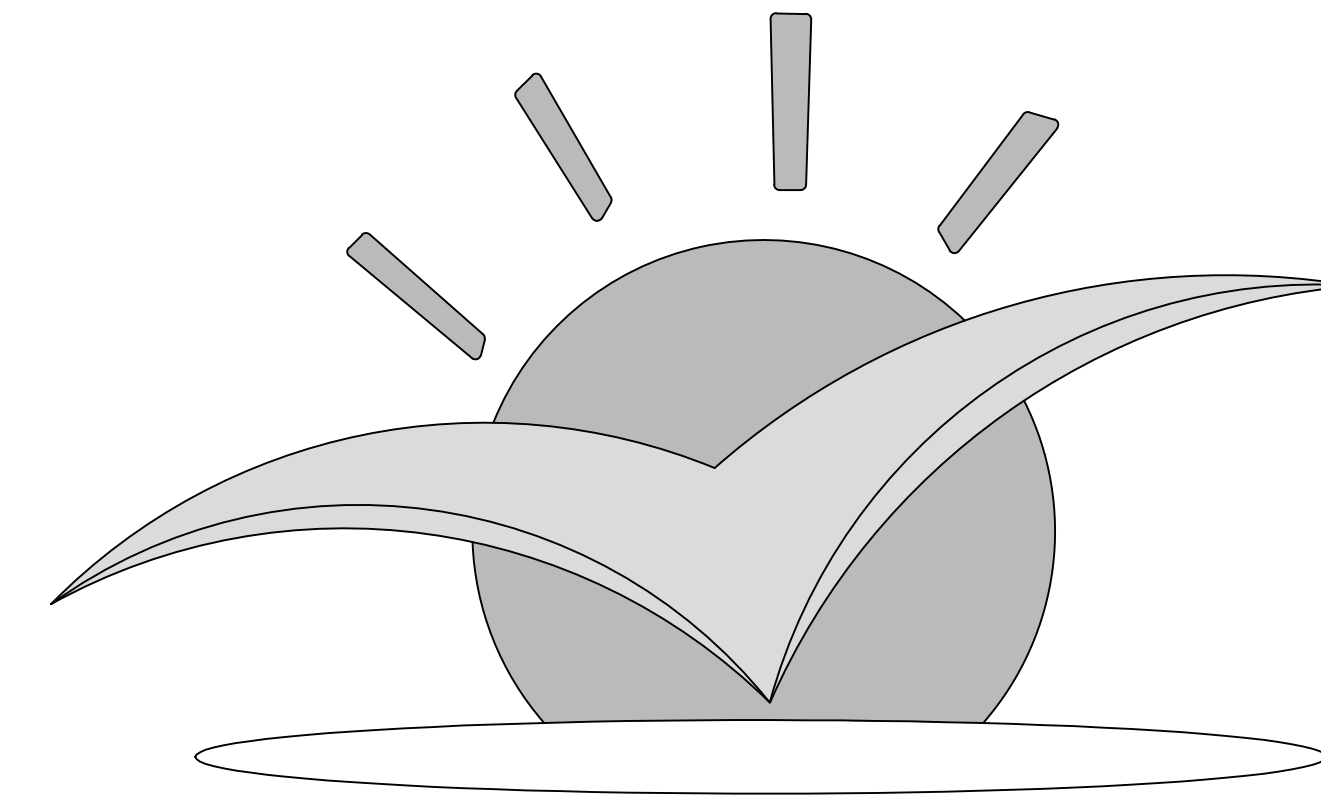

Halifax Regional School Board

DRAWING LIST:

ARCHITECTURAL

A-100 ROOF PLAN, LEGEND & NOTES
A-101 ROOF DETAILS

ATLANTIC VIEW ELEMENTARY ROOF REPLACEMENT

3391 LAWRENCETOWN RD.
LAWRENCETOWN, NS B2Z 1R5

ISSUE DATE: JULY 18, 2014

ARCHITECT

ARCHITECTURE | 49

1640 Market Street
Halifax, NS, B3J 2C8
T+1.902.429.5490
F+1.902.429.2632

www.architecture49.com

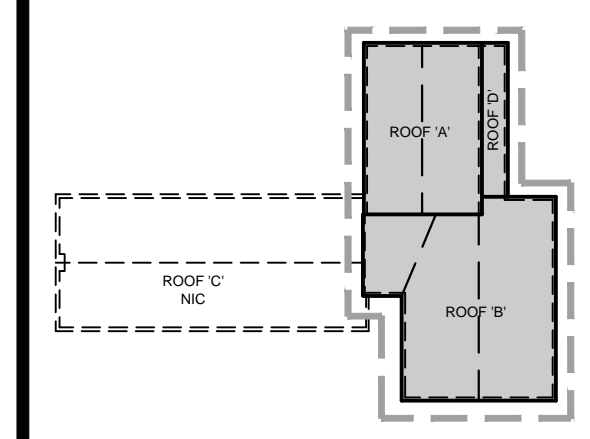

DESCRIPTION	NO.	DATE
REVISIONS		

REVISIONS

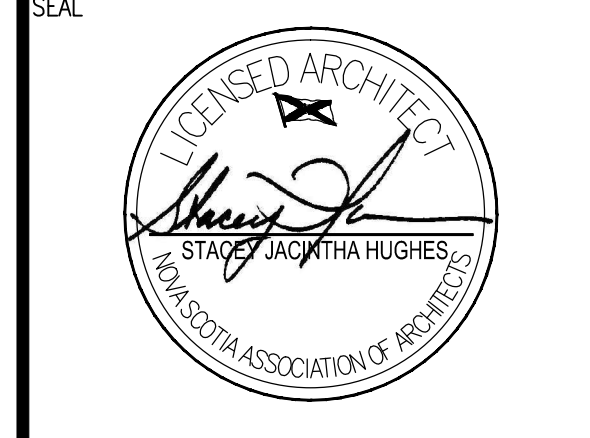
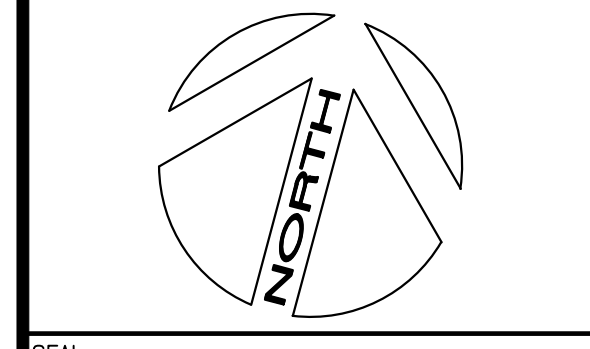

DRAWN	SCALE
OMK	AS NOTED
CHECKED	DATE
JW	JULY 18, 2014

APPROVED
SH



PROJECT
ATLANTIC VIEW ELEMENTARY

ROOF REPLACEMENT

LAWRENCETOWN, HFX. CO. NS
CITY PROVINCE

TITLE
ROOF PLAN, LEGEND & NOTES

COMMISSION NO.

PROJECT NO.

CONTRACT NO.

DWG. NO.

A-100

GENERAL NOTES

- CONTRACTOR TO VERIFY ALL DIMENSIONS & ACTUAL CONDITIONS ON SITE.
- REVIEW ALL EXISTING T&G WOOD ROOF DECK & ALL EXISTING WOOD OUTLOOKS & SLEEPERS FOR ANY DAMAGE & ROTTEN AREAS PRIOR TO INSTALLING ROOF MEMBRANE. REPLACE AS REQUIRED, TO MATCH EXISTING.

LEGEND

- VP EXISTING VENT PIPE LOCATION
- CH EXISTING CHIMNEY
- EQ ROOFTOP EQUIPMENT
- DS DOWNSPOUT

TYPICAL EXISTING ROOF CONSTRUCTION

- BALLAST, TO BE REMOVED
- EPDM MEMBRANE, TO BE REMOVED
- RIGID INSULATION, TO BE REMOVED.
- STEEL ROOF DECK, TO REMAIN, INSPECT FOR DAMAGED AREAS & REFER FOR UNIT PRICE FOR REPAIR/REPLACEMENT OF ANY DECKING.
- ROOF STRUCTURE, REFER TO UNIT PRICE FOR REPLACEMENT OF ANY STRUCTURAL COMPONENT.

TYPICAL NEW ROOF CONSTRUCTION

- 2 FLY MOD. BIT. MEMBRANE ROOFING SYSTEM
- 2 LAYERS 1/2" FIBREBOARD
- E.P.S. RIGID INSULATION TYPE "2" (R30)
- SELF-ADHESIVE VAPOUR BARRIER MEMBRANE
- 1/2" UNDERLAYMENT BOARD
- EXISTING STEEL ROOF DECK, TO REMAIN
- EXISTING ROOF STRUCTURE, TO REMAIN

N.T.S. **A1** LEGEND & NOTES
A-100

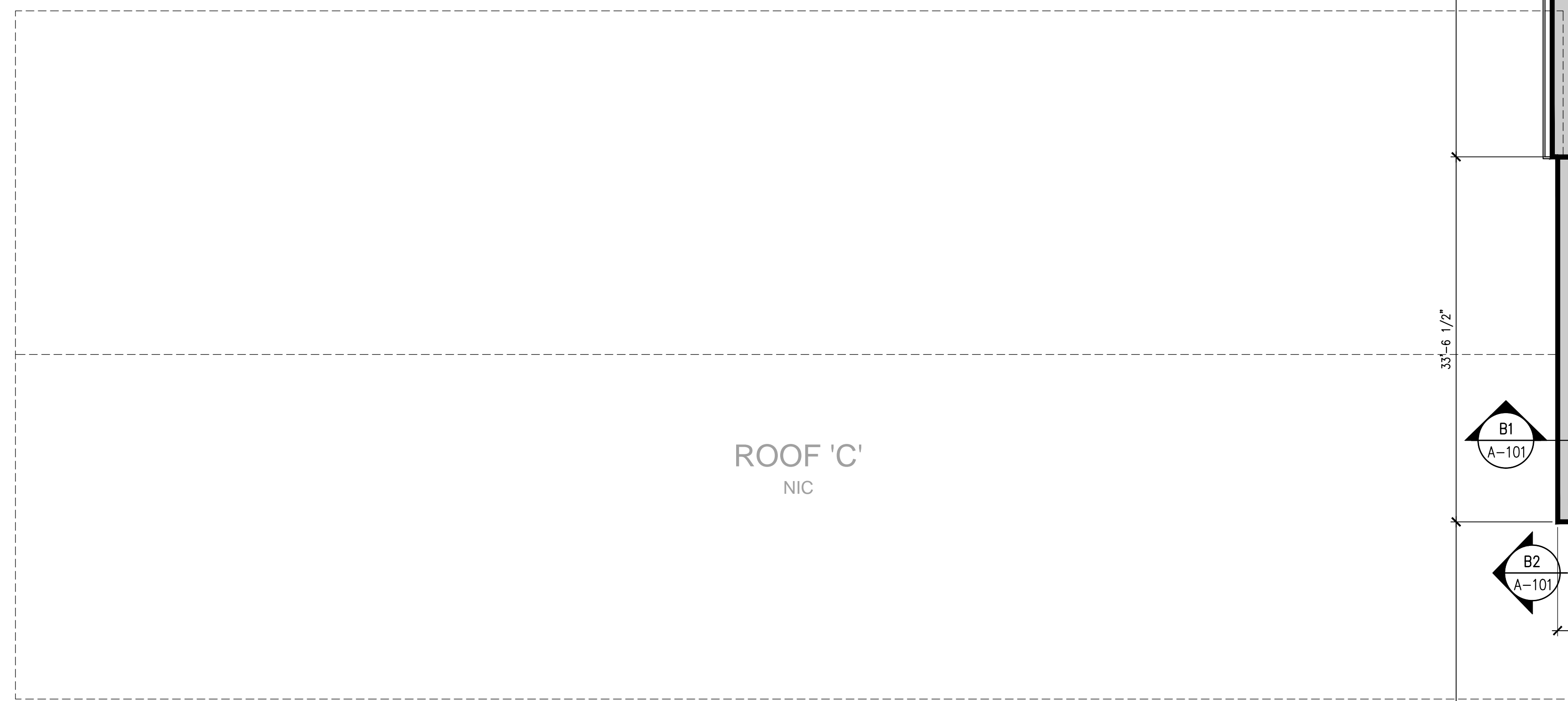

1/8" = 1'-0" **D1** ROOF PLAN
A-100

The Executed Agreement of the Halifax Regional School Board is to be read in conjunction with this Section.

PART 1 - GENERAL

1.1 SUMMARY OF SECTION

- .1 As summarized and described but not restricted to the following:
 - .1 Provide rough carpentry for work from other sections as noted.
 - .2 Provide rough carpentry work as indicated in Schedule.

1.2 REFERENCES

- .1 The standards listed form part of this Specification to the extent of reference. The publications are in the text by the basic designation only.
- .2 American Society for Testing and Materials International (ASTM):
 - .1 ASTM A123/123M-13 Standard Specification for Zinc (Hot Dipped Galvanized) Coatings on Iron and Steel Products.
 - .2 ASTM F1667 -11ae1, Standard Specification for Driven Fasteners: Nails, Spikes, and Staples.
 - .3 ASTM A653/A653M-13, Standard Specification for Steel Sheet, Zinc-Coated (Galvanized) or Zinc-Iron Alloy-Coated (Galvannealed) by the Hot-Dip Process for G-185 fasteners for use with ACQ wood
- .3 American Wood Protection Association (AWPA), Alkaline Copper Quarternary (ACQ) for all pressure treated wood.
- .4 Canadian Standards Association (CSA):
 - .1 CSA-B111-1974 (R2003), Wire Nails, Spikes and Staples.
 - .2 CAN/CSA-G164-M92 (R2003), Hot Dip Galvanizing of Irregularly Shaped Articles.
 - .3 CSA O80S2-05 Supplement to O80 Series-97, Wood Preservation
 - .4 CSA O151-09(R2014), Canadian Softwood Plywood.
- .5 ISO 14040:2006, Environmental management, Life Cycle Assessment, Principles and Framework.
- .6 National Building Code of Canada (NBCC) 2010.
- .7 National Lumber Grades Authority (NLGA), Standard Grading Rules for Canadian Lumber, 2010.

1.3 ENVIRONMENTAL REQUIREMENTS

- .1 Comply with requirements of Workplace Hazardous Materials Information System (WHMIS) regarding use, handling, storage and disposal of materials.
-

1.4 WASTE MANAGEMENT

- .1 Separate and recycle waste materials in accordance with Division 01 Requirements.
- .2 Separate wood waste and place in designated areas in the following categories for recycling: Solid wood/ softwood/ hardwood, composite wood, treated, painted, or contaminated wood in containers supplied by the Contractor.
- .3 Set aside damaged wood and dimensional lumber off-cuts for acceptable alternative uses (e.g. bracing, blocking, cripples, bridging, finger-joining, or ties). Store this separated reusable wood waste convenient to cutting station and area of work.
- .4 Do not burn scrap at the project site.
- .5 Separate corrugated cardboard and recycle.

1.5 DELIVERY, STORAGE AND PROTECTION OF PRODUCT

- .1 Deliver and store materials in compliance with Division 01 Requirements.
- .2 Comply with manufacturer's recommendations for handling, storage and protection during installation.
- .3 Protect and store materials off the ground, away from physical damage and from becoming wet, soiled or covered with ice or snow before, during and after installation.
- .4 Label packages to include material name, production date and/or product code.

1.6 QUALITY ASSURANCE/QUALITY CONTROL

- .1 Lumber identification: by grade stamp of an agency certified by Canadian Lumber Standards Accreditation Board.
- .2 Plywood identification: by grade mark in accordance with applicable CSA standards.

PART 2 - PRODUCTS

2.1 LUMBER MATERIAL

- .1 Softwood Lumber: unless specified otherwise:
 - .1 Softwood, SPF Species, NLGA Grade 2 (or better).
 - .2 G4S, (good four sides)
 - .3 Moisture content 19% or less in accordance with:
 - .1 CSA-O141
 - .2 NLGA Standard Grading Rules for Canadian Lumber

- .2 Furring, blocking, nailing strips: cants, curbs, backing and sleepers:
 - .1 Softwood, SPF series, NLGA Standard or better grade.
 - .2 Moisture content: 19% or less, in accordance with:
 - .1 CSA-O141
 - .2 NLGA Standard Grading Rules for Canadian Lumber.
- .3 The manufacturing process must adhere to Lifecycle Assessment (LCA) standards as per ISO 14040.
- .4 Use pressure treated lumber for all roof related items and when wood is in contact with concrete.
 - .1 Pressure treated wood (Alkaline Copper Quarternary) treatment in accordance with CSA-O80 Series

2.2 SOFT WOOD PANEL MATERIALS

- .1 Canadian Softwood Plywood: to CSA O151, standard construction.
- .2 Use pressure treated panels for all roof related items and when wood is in contact with concrete.
 - .1 Pressure treated wood (Alkaline Copper Quarternary) treatment in accordance with CSA-O80 Series.

2.3 FASTENERS

- .1 Nails, spikes and staples: to CSA B111 and ASTM F1667.
- .2 Bolts: 1/2" min. diameter unless indicated otherwise, complete with nuts and washers.
- .3 Proprietary fasteners: toggle bolts, expansion shields and lag bolts, screws and lead or inorganic fiber plugs, explosive actuated fastening devices, recommended for purpose by manufacturer.
- .4 Fasteners for ACQ wood must be galvanized to G-185 (as defined in ASTM A653/A653M) or better, stainless steel or ceramic coated fasteners approved for use with ACQ wood.

2.4 SEMI-RIGID INSULATION

- .1 Semi-Rigid Fibrous Insulation:
 - .1 Standard of Acceptance: specification based on Roxul Inc Semi-Rigid board, or approved alternate.
 - .2 Board Density: ASTM C612, 4.4 lbs/ft³ or 70 kg/m³
 - .3 Board Size: 16" (406 mm) OR 24" (610 mm) wide by 48" (1219 mm) long.
 - .4 Board Thickness: 1" (25 mm), OR 1.5" (38 mm), 2" (50 mm)
 - .5 Facing: unfaced
 - .6 Non-Combustable: ASTM E136, CAN/ULC S114
-

- .7 Thermal Resistance: R-Value 4.2 per inch. RSI-Value: 0.74m² k/w
- .8 Moisture Resistance: ASTM C1104, Moisture Absorption: 0.03% volume
- .9 Water Vapour Permeance: ASTM E96 (33.1 perm)
- .10 Acceptable Alternate Manufacturers:
 - .1 Thermafibre Inc.

PART 3 - EXECUTION

3.1 EXAMINATION

- .1 Verify that field conditions are acceptable and are ready to receive Work.
- .2 Site verify dimensions, tolerances and method of attachment with other Work.

3.2 INSTALLATION

- .1 Comply with requirements of NBC 2010.
- .2 Install rough bucks, nailers and linings to rough openings as required to provide backing for frames and other work.
- .3 Install sleepers as indicated.
- .4 Provide space framing and furring as indicated.
- .5 Align and plumb faces of furring and blocking to tolerance of 1:600.
- .6 Install backing, nailers, curbs and other wood supports as required, secure using ACQ approved fasteners at exterior locations.
- .7 Frame, anchor, fasten, tie and brace members to provide necessary strength and rigidity.
- .8 Countersink bolts where necessary to provide clearance for other work.

3.3 SCHEDULE

- .1 Roof Curbs for Parapets and Mechanical Equipment:
 - .1 Construction & Anchorage:
 - .1 PT 2x4 wood studs at 16" o.c.
 - .2 ½" pressure treated plywood, both sides mechanically fastened at 6" o.c.
 - .3 Semi Rigid Batt Insulation; Standard of Acceptance Roxul or Thermafibre or accepted alternate
 - .4 Refer to details for height of curb and extent.
 - .5 Ensure curb is leveled around perimeter.
 - .2 Optional Assembly: Solid wood curb constructed of built-up layers of PT wood.

- .2 Roof Curbs for Chimneys:
 - .1 Construction & Anchorage:
 - .1 6" steel studs at 16" o.c.
 - .2 ½" overlayment board, both sides mechanically fastened at 6" o.c.
 - .3 Semi Rigid Batt Insulation; Standard of Acceptance Roxul or Thermafibre or accepted alternate
 - .4 Refer to details for height and extent of chimney surround.
 - .5 Ensure curb is leveled around perimeter.

3.4 CLEANING

- .1 Perform cleaning as soon as possible after installation to remove construction and accumulated environmental dirt.
- .2 Upon completion of installation, remove surplus materials, rubbish, tools and equipment barriers.

END

The Executed Agreement of the Halifax Regional School Board is to be read in conjunction with this Section.

PART 1 - GENERAL

1.1 SUMMARY OF SECTION

- .1 As summarized and described herein, but not restricted to the following:
 - .1 Remove the existing 4-ply built up roofing system, flashing, insulation, vapour barrier, down to the existing metal deck as noted on the drawings.
 - .2 Provide new two-ply modified bituminous membrane roofing system as noted on drawings with provision for FM Class 1-90 wind uplift standards.
 - .3 To temporarily remove mechanical exhaust fans, and provide new curbs and upstand, provide metal duct extensions, and replace once roofing and flashing is in place.
 - .4 Provide all built-up parapets, blocking curb extensions as required.
 - .5 Provide new roof drains where noted on the documents.
 - .6 Provide new roof flashing tie-ins to existing wall systems.
 - .7 To provide fit-ups to roof deck if uncovered and has deteriorated, as a Unit Price. Refer to paragraph 1.4 of this section and Tender/Bid Document for additional information.

1.2 ACCEPTABLE ROOFING ASSEMBLIES

- .1 The following assemblies are acceptable for use on this project. Materials are listed in Part 2. Alternate assemblies will only be considered during the bidding phase.
 - .1 Roof Assembly option 'A'
 - .1 Existing roof deck to remain.
 - .2 ½" Underlayment Board
 - .3 Vapour Barrier
 - .4 Expanded Polystyrene Rigid Insulation
 - .5 ½" Overlayment Board – mechanically fastened to 1-90
 - .6 ½" Overlayment Board – cold adhered
 - .7 Modified Bitumen Base – cold adhered
 - .8 Modified Bitumen Cap – torch applied
 - .2 Roof Assembly option 'B'
 - .1 Existing roof deck to remain.
 - .2 ½" Underlayment Board
 - .3 Vapour Barrier
 - .4 Expanded Polystyrene Rigid Insulation
 - .5 ½" Overlayment Board – mechanically fastened to 1-90
 - .6 ½" Overlayment Board with Modified Bitumen Base – cold adhered
 - .7 Modified Bitumen Cap – torch applied
-

- .3 Roof Assembly option 'C'
 - .1 Existing roof deck to remain.
 - .2 ½" Underlayment Board
 - .3 Vapour Barrier
 - .4 Polyisocyanurate Rigid Insulation– mechanically fastened to 1-90
 - .5 ½" Overlayment Board – cold adhered
 - .6 Modified Bitumen Base – cold adhered
 - .7 Modified Bitumen Cap – torch applied

- .4 Roof Assembly option 'D'
 - .1 Existing roof deck to remain.
 - .2 ½" Underlayment Board
 - .3 Vapour Barrier
 - .4 Polyisocyanurate Rigid Insulation– mechanically fastened to 1-90
 - .5 ½" Overlayment Board with Modified Bitumen Base – cold adhered
 - .6 Modified Bitumen Cap – torch applied

1.3 REFERENCES

- .1 American National Standards Institute (ANSI) Factory Mutual (FM):
 - .1 ANSI/FM Approval 4474, Evaluating the Simulated Wind Uplift Resistance of Roof Assemblies Using Static Positive and/or Negative Differential Pressures (Class range from 1-60 to 1-990).

 - .2 American Society for Testing and Materials International (ASTM):
 - .1 ASTM C208-12, Specification for Cellulosic Fiber Insulating Board.
 - .2 ASTM C578-12b, Specification for Rigid, Cellular Polystyrene Thermal Insulation.
 - .3 ASTM C1177/C1177M-13, Glass Mat Gypsum Substrate for Use as Sheathing
 - .4 ASTM D6164/D6164M-11, Styrene Butadiene Styrene (SBS) Modified Bituminous Sheet Materials Using Polyester Reinforcements.
 - .5 ASTM D4586/D4586M-07(2012)e1, Asphalt Roof Cement, Asbestos Free

 - ..3 Canadian General Standards Board:
 - .1 CGSB 37-GP-9Ma, Primer, Asphalt, Unfilled, for Asphalt Roofing, Dampproofing and Waterproofing.

 - .4 Canadian Roofing Contractors' Association (CRCA) – Roofing Specifications Manual.

 - .5 Nova Scotia Construction Safety Association (NSCSA), Occupational Health and Safety Act (OHSA)

 - .6 Underwriters Laboratories of Canada (ULC):
 - .1 CAN/ULC S701-11 EN, Standard for Thermal Insulation, Polystyrene, Boards and Pipe Covering.
-

1.4 UNIT PRICES

- .1 Refer to the Tender/Bid Documents for Unit Prices:
 - .1 Unit Price #1: Provide a Unit Price for the replacement of the existing roof decking.
 - .2 Unit Price #2: Provide a Unit Price for the replacement of the existing wood blocking, parapets, and/or curbs that are noted to remain, but that may contain rot and/or damage, if deemed unusable.

1.5 SUBMITTALS

- .1 Provide shop drawings including manufacturers technical data sheets and installation methods for each component. Include a summary of the roofing system from top to bottom.
 - .1 Ensure manufacturer products specified are as prescribed by FM Class 1-90 wind uplift recommendations.
 - .2 Provide layout for tapered areas of rigid insulation. Ensure tapered insulation noted for roof areas indicate a positive slope to drain.
 - .3 Provide fastening layouts meeting FM Class 1-90 requirements, for field, edge and corner locations.

1.6 ENVIRONMENTAL REQUIREMENTS

- .1 Comply with requirements of Workplace Hazardous Materials Information System (WHMIS) regarding use, handling, storage and disposal of materials.
- .2 Refer to the Manufacturer's recommendations regarding installation of roofing system at ambient temperatures. Roofing system should be applied when temperatures are above 0°C.
- .3 Refer to the Manufacturer's recommendations of temperatures required for conditioning the materials prior to application and install and curing after.
- .4 Install roofing on dry deck, free of snow and ice, use only dry materials and apply only during weather that will not introduce moisture into roofing system.
- .5 Only 'Dry' materials are to be installed. Materials that are installed wet, or materials that become wet during inclement weather to be removed and replaced.

1.7 SAFETY REQUIREMENTS

- .1 Refer to the HRSB Documents on Safety.
 - .2 Contractor to abide by NSCSA Occupational Health and Safety Act.
-

- .3 Ensure all roof installers have taken the NSCSA Fall Protection course and abide by the NSCSA Fall Protection Course Guidelines.
- .4 Contractor to be cognizant of proper protection of removal of roofing from the building and site. Ensure Project Manager is advised re the proposed location and protection.

1.8 WASTE MANAGEMENT

- .1 Contractor to remove debris immediately from site to a designated landfill approved by Provincial Regulations to accept existing roofing materials debris.

1.9 PERFORMANCE CRITERIA

- .1 Compatibility between components of roofing system is essential. Provide written declaration to Consultant stating that materials and components, as assembled in system, meet this requirement.
- .2 Do roofing work in accordance with applicable, standard in Canadian Roofing Contractors Association (CRCA) Roofing Specifications Manual and to prescribed FM Class 1-90 wind uplift requirements where mechanically fastened.

1.10 DELIVERY, STORAGE AND PROTECTION OF PRODUCT

- .1 Comply with manufacturer's recommendations for handling, storage and protection during installation.
 - .2 Protect and store materials off the ground, away from physical damage and from becoming wet, soiled or covered with ice or snow before, during and after installation.
 - .3 Removal and replacement of roof drains and removal and reinstatement of existing mechanical units to be completed by a subcontractor qualified to complete the identified work.
 - .4 Label packages to include material name, production date and/or product code.
 - .5 Store rolls of felt and membrane in upright position. Store membrane rolls with salvage edge up.
 - .6 Remove only in quantities required for same day use.
 - .7 Place plywood runways over work to enable movement of material and other traffic.
 - .8 Store roofing material at +5C minimum.
-

1.11 QUALITY ASSURANCE/QUALITY CONTROL

- .1 Convene pre-installation meeting one week prior to beginning work of this Section.
 - .1 Verify project requirements.
 - .2 Review installation and substrate conditions.
 - .3 Co-ordinate with other building subtrades.
 - .4 Review manufacturer's installation instructions and warranty requirements.
 - .5 Record meeting proceedings including corrective measures and other actions required to ensure successful completion of work and distribute to each attendee within one week of meeting.
- .2 Certificates: product certificates signed by manufacturer certifying materials comply with specified performance characteristics and criteria and physical requirements.
- .3 Roofing applicator must be a good standing member of the CRCA and approved by the Roof Manufacturing Company selected on this Project, and have completed projects of this magnitude in the last five (5) years.
- .4 Contractor to hold pre-construction meeting with Manufacturer's Technical Representative to review the substrate condition and review the process of installation. Manufacturer's Representative to visit site three (3) times unannounced during construction and once at completion and provide inspection reports to the Consultant.

1.12 FIRE WATCH

- .1 Fire Extinguishers: maintain one cartridge operated type with hose and shut-off nozzle, ULC labelled for A, B and C class protection, within 3 meters of torch applicator.
- .2 Cease torching at least three (3) hours before leaving for the day and maintain fire watch for two (2) hours after each day's roofing operations cease.
- .3 Designate a person, equipped with a fire extinguisher and a cell phone, responsible in the event of a fire, to do a mandatory walk-about to check for hot spots.
- .4 Make sure all workers know the escape route.

1.13 TEST REPORTS

- .1 If required by the Owner, provide a third party roof inspection company to check and verify all systems from Shop Drawing review, to Roof preconstruction. Meetings to review during the application of the system.
 - .2 Provide interim written reports during the application to the Consultant.
 - .3 Infrared testing of the entire roof will be required and will include all field applications. Testing of flashing: at cap flashing, roof to wall flashing, etc., and at all roof drains. Provide infrared testing of all seam testing.
-

- .4 Qualifications of the required test will be as follows:
 - .1 Upon completion of the Primary Waterproofing Membrane, Protection Course, and all associated terminations, the Contractor shall test the system.
 - .2 Repair and retest the system, report all deficiencies to the Consultant.
 - .3 No other Work is to proceed without prior direction from the Consultant.
- .5 Submit copies of all test reports to the Consultant.
- .6 All costs of the third party testing, if required, will be borne by the Owner.

1.14 WARRANTIES

- .1 Roofing Contractor to supply the Owner with a CRCA warranty certifying work completed as installed to be free of roof defect for a period of two (2) years from date of substantial performance.
- .2 Provide manufacturer's membrane warranty (non-pro-rated) in the name of the Owner, stating roofing system will remain watertight for a period of a full ten (10) years from the date of substantial completion. This warranty is to include both labour and materials necessary to affect water tightness.

PART 2 - PRODUCTS

2.1 UNDERLAYMENT BOARD

- .1 Mold and Moisture Resistant, non-combustible, solid core underlayment board to provide smooth surface for Air/Vapour Barrier application.
- .2 Manufactured as per ASTM C1177/C1177M.
- .3 Size Boards: 48" (1220 mm) wide x 96" (2440 mm) long x 1/2" (12.7mm) thick minimum.
- .4 Standard of Acceptance based on the following, or approved alternate:
 - .1 CGC Securock Glass mat Roof Board
 - .2 Georgia Pacific DensDeck Prime Roof Board.

2.2 VAPOUR BARRIER

- .1 SBS Modified bitumen, self-adhering membrane, reinforced with skid resistant polyethylene surface film.
 - .2 Self gasketing material with fully adhered system that has split release backing for fast application.
-

- .3 Suitable for application on top of roof underlayment board and serves as full coverage waterproofing layer in roof assembly.
- .4 Primer as required by manufacturer.
- .5 Thickness: 1.0 mm (40 mils)
- .6 Water Vapour Transmission: 0.05 perms
- .7 Standard of Acceptance: Blueskin PE 200 HT by Henry Company
- .8 Approved Alternates:
 - .1 IKO MVP
 - .2 Soprema Sopravap'r

2.3 EXPANDED POLYSTYRENE INSULATION

- .1 Polystyrene Insulation Type I or Type II Board manufactured to CAN/ULC-S701 and ASTM C578. Contains no CFC, HCFC or HFC blowing agents.
- .2 Size Board: 4'-0" (1220 mm) x 4'-0" (1220 mm)
- .3 Thermal Resistance: R value = R30
- .4 Tapered Insulation: where noted on the drawings.
- .5 Edges ship lapped, or insulation applied in two layers with staggered joints.

2.4 POLYISOCYANURATE RIGID INSULATION

- .1 Polyisocyanurate roof insulation Type 2 or Type 3 manufactured to CAN/ULC-S704-03 or CAN/ULC-S704-11.
 - .2 Size Board: 4'-0" (1220 mm) x 4'-0" (1220 mm) or 4'-0" (1220 mm) x 8'-0" (2440 mm)
 - .3 Physical Properties
 - .1 Compressive strength: 140kPa minimum
 - .2 Water absorption: 3.5% max (by volume)
 - .4 Thermal Resistance: R value = R30
 - .5 Mechanically fastened through deck with purpose made screws and plates. Fastening is to meet 1-90 wind uplift requirements.
 - .6 Tapered Insulation: refer to roof plans for extent and dimensions of tapered insulation.
 - .7 Edges ship lapped, or insulation applied in two layers with staggered joints
-

2.5 ROOFING ADHESIVES

- .1 Insulation and Overlayment Board Adhesive:
 - .1 Must be compatible with roofing system components, and meet roofing warranty requirements.
 - .2 Meets 1-90 wind uplift requirements.
 - .3 Low rise, low odor, foam adhesive.
 - .4 IKO Millennium or equivalent
- .2 Membrane Adhesive:
 - .1 Must be compatible with roofing system components, and meet roofing warranty requirements.
 - .2 Meets 1-90 wind uplift requirements.
 - .3 Solvent-free adhesive designed for cold application of roofing membranes.
 - .4 IKO Cold Gold adhesive or equivalent

2.6 OVERLAYMENT BOARD

- .1 Uniform, moisture resistant, fiberboard with premium wax resins to ASTM C208 high density, Type II, Grade 2.
- .2 Size boards: 4' (1220mm) x 8' (2440mm)
- .3 Thickness boards: 1/2" (13mm)
- .4 Physical Properties:
 - .1 Compressive Strength: 240 kPa min.
 - .2 Water Absorption: 7% volume max.
 - .3 Linear expansion: 0.5% max.
- .5 Acceptable Products:
 - .1 Vanguard Fiberboard High Density
 - .2 IKO Protection Board – Protectoboard
 - .3 Georgia Pacific commercial roof fiberboard
 - .4 Soprema Sopraboard
 - .5 Celotex Structodek

2.7 OVERLAYMENT BOARD WITH INTEGRAL BASE SHEET

- .1 1/2" high density fibreboard with integral 180 g/m base sheet. Top face thermofusible film for torch application of cap sheet.
 - .2 Meets CAN/ULC-S706 and ASTM C208
 - .3 Cold adhered installation only, to meet 1-90 wind uplift requirements.
-

- .4 Membrane edges self-adhesive or cold adhered.
- .5 Acceptable products: Roofcraft-180-base-f/r-polyester, Lexbase-180-fr-Polyester or approved alternate.

2.8 ROOF MEMBRANES

- .1 Base Sheet: 180 g/m:
 - .1 Non-woven reinforcing matt, polyester coated and permeated with SBS modified bitumen. This membrane is applied with cold adhesive.
 - .2 Thickness: 2.2mm (87mils)
 - .3 Bottom side coated with sand to allow adhesion with cold process adhesive.
 - .4 Top surface thermofusible film to allow adhesion with torch applied cap.
 - .5 Manufactured to ASTM D6164 for Type 1, Grade 'S' materials.
 - .6 Standard of Acceptance based on IKO MP-180-FS-Base.
 - .7 Approved Alternate Manufacturers:
 - .1 Soprema
 - .2 Bakor by Henry Company
 - .3 Polyglass
 - .2 Base Sheet Flashing 180 g/m:
 - .1 Non-woven reinforcing matt, polyester coated and permeated with Modiflex SBS bitumen, self-adhering one side, thermo fusible plastic film over.
 - .2 Thickness: 2.5mm (98mils)
 - .3 Poly Film (thermo fusible) covers the top surface; the back surface is self-adhered, silicone treated film.
 - .4 Manufactured to ASTM D6164.
 - .5 Primer as per manufacturer's recommendations.
 - .6 Standard of Acceptance based on IKO Armour Bond Flash.
 - .7 Approved Alternate Manufacturers:
 - .1 Soprema
 - .2 Bakor by Henry Company
 - .3 Polyglass
 - .3 Cap Sheet and Cap Flashing 250g/m:
 - .1 Non-woven reinforcing mat, strengthened with selected glass fibre strands, coated and permeated with SBS modified bitumen. The underside to be protected by thermofusible plastic film. Membrane to be applied by torching only.
 - .2 Thickness: 4.0mm (158mils)
 - .3 Coloured ceramic mineral granules embedded into top surface to provide protection against ultraviolet radiation.
 - .4 Manufactured to ASTM D6164 for Type II, Grade G materials.
 - .5 Standard of Acceptance based on IKO Torchflex TP 250 CAP
 - .6 Approved Alternate manufacturers:
 - .1 Soprema
 - .2 Bakor by Henry Company.
 - .3 Polyglass
-

PART 3 - EXECUTION

3.1 EXAMINATION

- .1 Manufacturer's Technical Representative to examine roof decks and immediately inform the Consultant, in writing, of defective areas requiring replacement, and that the substrate is acceptable for the new roofing system.

3.2 REMOVAL OF THE EXISTING ROOFING MATERIAL

- .1 Contractor to note the existing roofing material is BUR system including membrane, insulation and ballast on roof deck.
- .2 Remove the existing roofing down to existing roof deck. Take care when removing this material. Intent is not to damage the existing deck.
- .3 Contractor only to remove enough section of the existing that can be recovered with new in one day. At the end of each working day, ensure the existing/new junction is made watertight.
- .4 Ensure all removal material is properly placed in on-site refuse containers, and removed from site on a daily basis. Location of the onsite refuse container to be determined by the Project Manager. Contractor to provide off-site disposal area that is acceptable to the authority having jurisdiction.
- .5 Contractor to ensure any asphaltic cutback from the existing vapour barrier is removed from the wood deck.
- .6 Contractor to provide protection to all interior areas below the roof being modified. Ensure dust and dirt is contained and removed from site.
- .7 Contractor to confirm if repairs are required to the wood deck, refer to unit pricing paragraph 1.4.

3.3 PREPARATION OF SUBSTRATE

- .1 Prior to installation of roof system verify:
 - .1 Decks are firm, straight, smooth, dry, free of snow, ice or frost, and swept clean of dust, debris and ready for primer.
 - .2 Curb upstands have been installed for mechanical services requiring curbs, supports etc.
 - .3 Roof drains have been installed at proper elevations relative to finished roof surface.
-

3.4 INTERFACE WITH OTHER SYSTEMS

- .1 Coordinate roof systems with Section 07 62 00 Sheet Metal Flashing and Trim.
- .2 Coordinate the installation of roof drains supplied by Mechanical Components.
- .3 Provide temporary weathertight cover over mechanical upstand curbs.
- .4 Coordinate the installation of the roof mounted equipment and roof curbs by other trades for support and fastening.

3.5 INSTALLATION

- .1 Underlayment Board Installation:
 - .1 Mechanically fasten the underlayment board to the roof deck with adequate fastening for temporary securement. Final securement is to be provided by the mechanical fastening of the layers above.
 - .2 Air Vapour Barrier Installation:
 - .1 Apply the self-adhering air vapour barrier membrane to the underlayment board in accordance with manufacturer's recommendations.
 - .2 Prime the underlayment board and install self-adhered vapour barrier to the underlayment board.
 - .3 Temperature is to be above 5°C when applying the membrane.
 - .4 Apply the air/vapour barrier in direction of slope or perpendicular to slope. When applied perpendicular to slope, apply beginning at low point of and proceed in "shingle fashion". Position sheet to achieve correct overlap and alignment.
 - .5 Verify there are no air bubbles or fish mouths in the application.
 - .6 Tie-ins to other wall areas of the building envelope are to be properly tied in to form a complete and continuous air/vapour enclosure, roof and wall conditions.
 - .3 Insulation Panel Installation:
 - .1 Ensure the insulation panels are tightly fitted together.
 - .2 Discard broken insulation boards.
 - .3 Voids are to be completely filled with insulation.
 - .4 Install insulation to fit tightly next to curbs, parapets and roof protrusions.
 - .4 Overlayment Board Installation:
 - .1 Where two layers of underlayment board are used, mechanically fasten the first layer of overlayment board over the insulation panels, through rigid insulation panel to the roof deck to requirements of FM Class 1-90. Fasteners to be a minimum of 6" (150 mm) from the board edge. Stagger joints of two layers of protection board to fully protect insulation panels.
 - .2 Fasteners and fastening pattern to agree with the approved shop drawings for this project.
-

- .3 Fastener length should reflect the thickness of the insulation and the protection board. Contractor to review the location of conduit mounted to the underside of the steel deck, and verify that fasteners bypass the conduit. Contractor to repair damage or disruption to the cable/conduit under this contract.
- .4 Adhere top layer of protection board in accordance with the manufacturer's instructions with overlapping joints of the protection board installed prior.
- .5 If an overlayment board with integral base is used it is to be installed using a cold adhered process. No mechanical fastening will be permitted.

- .5 Base Sheet and Flashing Installation:
 - .1 Base sheet membrane to be fully adhered over protection board with cold process adhesive ensuring joints terminations are fully buttered. Each strip to have 3" (75mm) side laps and 6" (150mm) end laps.
 - .2 Base sheet to be re-rolled from both ends.
 - .3 Adhere the base sheet flashing after primer application is fully dried.
 - .4 Application to provide a smooth surface, free of air pockets, wrinkles, fishmouths or tears.
 - .5 Apply membrane perpendicular to slopes for roofs of less than 1:12 slope. Apply membrane parallel to slope on roofs of 1:12 or greater.
 - .6 Apply self-adhesive membrane for flashing and penetrations.

- .6 Cap Sheet Installation:
 - .1 Once the base sheet and stripping has been applied and does not show defects, the cap sheet can be laid.
 - .2 Cap sheet to be unrolled starting from the low point of the roof. Cap sheet to be rerolled from both ends prior to torching. Care must be taken for good alignment of the first roll (parallel with the edge of the roof).
 - .3 Cap sheet to be torch welded on to the base sheet membrane, in accordance with recommendations of the membrane manufacturer. During this application, both surfaces to be simultaneously melted, forming an asphalt bead, pushed out in front of the cap sheet. While the membrane is still hot, apply enough pressure with a steel roller onto the side lap so as to have bitumen seep out to create a continuous bead of bitumen on the side lap. Care should be taken not to embed the granules into the bitumen.
 - .4 Care must be taken not to burn the membranes, and their respective reinforcements.
 - .5 Base sheet and cap sheet seams to be staggered a minimum of 1'-0" (300 mm).
 - .6 Cap sheet to have side laps of 3" (75 mm) and end laps of 6" (150 mm). Surface granules on end laps to be embedded prior to installation of following sheet.
 - .7 Make sure the two membranes are properly welded, without air pockets, wrinkles, fishmouths or tears.
 - .8 After installation of the cap sheet, check lap seams on the cap sheet.
 - .9 During installation, care must be taken to avoid asphalt seepage greater than 1/5" (5 mm) at seams.

3.6 PROTECTION DURING WORK

- .1 Cover walls and adjacent work where materials hoisted or used.
-

- .2 Use warning signs and barriers. Maintain in good order until completion of work.
- .3 Clean off drips and smears of bituminous material immediately.
- .4 Dispose of rain water off roof and away from face of building until roof drains are installed and connected.
- .5 Protect roof from traffic and damage. Comply with precautions deemed necessary by Consultant.
- .6 At end of each day's work or when stoppage occurs due to inclement weather, provide protection for completed work and materials out of storage.
- .7 Place plywood runways over work to enable movement of materials and other traffic.
- .8 Contractor to ensure only as much of the roofing material removed from the roof as can be made watertight and secure by days end.
- .9 Contractor is solely responsible for water damage, to the interior of the building caused by lack of protection of the system during the deconstruction or construction of this roofing system.

3.7 PROTECTION AFTER WORK COMPLETED

- .1 Contractor to repair damage caused by work of this contract - to adjacent roof and wall areas, and also to site areas such as lawns or paved areas that have damage caused by this contract.
- .2 Contractor responsible to protect and cover interior areas for dust cover and migration of dirt stemming from work above.

3.8 CLEANING

- .1 Contractor to provide clean-up for this roofing area. Debris and excess roofing items to be removed from the site.

END

The Executed Standard Agreement of the Halifax Regional School Board is to be read in conjunction with this Section.

PART 1 GENERAL

1.1 SUMMARY OF SECTION

- .1 As summarized and described but not restricted to the following:
 - .1 To remove all flashings at the perimeter of the building and all equipment bases.
 - .2 To provide new metal flashings at the reinstated roof equipment.
 - .3 To provide metal flashing around perimeter of roof area.

1.2 REFERENCES

- .1 The standards listed form part of this Specification to the extent of reference. The publications are in the text by the basic designation only.
- .2 American Society for Testing and Materials International (ASTM):
 - .1 ASTM A653/A653M-13, Specification for Steel Sheet, Zinc-Coated (Galvanized) or Zinc-Iron Alloy Coated (Galvannealed) by the Hot-Dip Process.
 - .2 ASTM D523-14, Test Method for Specular Gloss
 - .3 ASTM D822/D822M-13, Practice for Filtered Open Flame Carbon Arc Exposures of Paint and Related Coatings
 - .4 ASTM F1667-11a e1, Driven Fasteners: Nails, Spikes and Staples
 - .5 ASTM D4586/D4586M-07(2012)e1, Standard Specification for Asphalt Roof Cement, Asbestos-Free
- .3 Canadian General Standards Board:
 - .1 CAN/CGSB 51.32-M77 Sheathing, Membrane, Breather Type

1.3 SUBMITTALS

- .1 Samples:
 - .1 Submit duplicate 50 x 50 mm samples of each type of sheet metal material, colour and finish.

1.4 ENVIRONMENTAL REQUIREMENTS

- .1 Comply with requirements of Workplace Hazardous Materials Information System (WHMIS) regarding use, handling, storage and disposal of materials.

1.5 WASTE MANAGEMENT

- .1 Separate and recycle waste materials in accordance with Division 01 Requirements.
-

1.6 DELIVERY, STORAGE AND PROTECTION OF PRODUCT

- .1 Comply with manufacturer's recommendations for handling, storage and protection during installation.
- .2 Protect and store materials off the ground, away from physical damage and from becoming wet, soiled or covered with ice or snow before, during and after installation.
- .3 Label packages to include material name, production date and/or product code.

PART 2 - PRODUCTS

2.1 MATERIALS

- .1 Prefinished Steel Sheet Flashing
 - .1 Prefinished steel, with factory applied silicone modified polyester.
 - .1 To ASTM A653/A653M Z275 zinc coating designation; 22 gauge core steel. Shop pre-coated with modified silicone.
 - .2 Class F1S.
 - .3 Specular gloss: 30 units +/- 5 in accordance with ASTM D 523
 - .4 Resistance to accelerated weathering for chalk rating of 8, colour fade 5 units, or less erosion rate less than 20% for ASTM D822
 - .1 Outdoor exposure 1000 hrs
 - .2 Humidity resistance 1000 hrs
 - .5 Ensure minimum 2" vertical leg on sheet metal flashing
 - .2 Brake Form Aluminum Flashing
 - .1 Brake form on site to cover the existing fascia, 20g. Ensure all fasteners are hidden.

2.2 ACCESSORIES

- .1 Isolation coating: alkali resistant bituminous paint.
 - .2 Plastic cement: to ASTM D4586 Type I.
 - .3 Underlay for metal flashing: dry sheathing to CAN/CGSB-51.32.
 - .4 Cleats: of same material as flashing specified, and temper as sheet metal, minimum 2" wide. Thickness 22 gauge.
 - .5 Fasteners: of same material as sheet metal, to ASTM F1667, ring thread flat head roofing nails of length and thickness suitable for metal flashing application.
 - .6 Washers: of same material as sheet metal, with rubber packings.
-

2.3 FABRICATION

- .1 Fabricate metal flashings and other sheet metal work in accordance with applicable CRCA 'FL' series details as indicated.
- .2 Form pieces in 8'-0" maximum lengths. Make allowance for expansion at joints.
- .3 Hem exposed edges on underside 1/2". Miter and seal corners with sealant.
- .4 Form sections square, true and accurate to size, free from distortion and other defects detrimental to appearance or performance.
- .5 Apply isolation coating to metal surfaces to be embedded in concrete.

PART 3 - EXECUTION

3.1 INSTALLATION

- .1 Use concealed fastenings except where approved before installation, fasteners installed at 2'-0" o.c.
- .2 Provide underlay under sheet metal. Secure in place and lap joints 4".
- .3 Counterflash bituminous flashings at intersections of roof with vertical surfaces and curbs. Flash joints using S-lock forming tight fit over hook strips.
- .4 Lock end joints and caulk with sealant.
- .5 Install surface mounted reglets true and level, and caulk top of reglet with sealant.
- .6 Insert metal flashing into reglets under cap flashing to form weathertight junction.
- .7 Caulk flashing at reglet cap flashing with sealant.
- .8 Cut triangle on diagonal joint to minimize cut joint.

END

The Executed Agreement of the Halifax Regional School Board is to be read in conjunction with this Section.

PART 1 – GENERAL

1.1 REFERENCES

- .1 American Society for Testing and Materials (ASTM)
 - .1 ASTM B32-2008, Specification for Solder Metal.
 - .2 ASTM B306-13, Specification for Copper Drainage Tube (DWV).
 - .3 ASTM C564-14, Specification for Rubber Gaskets for Cast Iron Soil Pipe and Fittings.
 - .4 ASTM B209M-10, Specification for Aluminum and Aluminum Alloy Sheet and Plate Metric.
 - .5 ASTM C335/C335M-10e1, Test Method for Steady State Heat Transfer Properties of Horizontal Pipe Insulation
 - .6 ASTM C449-07(2013), Standard Specification for Mineral Fibre Hydraulic Setting Thermal Insulating and Finishing Cement.
 - .7 ASTM C533-13, Standard specification for Calcium Silicate Insulation Block and Pipe.
 - .8 ASTM C534/C534M-13, Standard Specification for Preformed Elastomeric Cellular Thermal Insulation in Sheet And Tubular Form.
 - .9 ASTM C547-12, Standard Specification for Mineral Fibre Pipe Insulation.
 - .10 ASTM C921-10, Practice for Determining the Properties of Jacketing Materials for Thermal Insulation.
 - .2 Canadian General Standards Board (CGSB)
 - .1 CGSB 51GP52Ma, Vapour Barrier, Jacket and Facing Material for Pipe, Duct and Equipment Thermal Insulation.
 - .2 CAN/CGSB51.53, Poly (Vinyl Chloride) Jacketing Sheet, for Insulated Pipes, Vessels and Round Ducts.
 - .3 Manufacturer's Trade Associations
 - .1 Thermal Insulation Association of Canada (TIAC): National Insulation Standards.
 - .4 Underwriters' Laboratories of Canada (ULC)
 - .1 CAN/ULCS102-10, Surface Burning Characteristics of Building Materials and Assemblies.
 - .2 CAN/ULCS701-11 Thermal Insulation, Polystyrene, Boards and Pipe Covering.
 - .3 CAN/ULCS702-09, Thermal Insulation, Mineral Fibre, for Buildings
 - .5 Canadian Standards Association (CSA)
 - .1 CAN/CSA B70-12, Cast Iron Soil Pipe, Fittings and Means of Joining.
 - .2 CAN/CSA B125.3-12, Plumbing Fittings.
-

1.2 QUALIFICATIONS

- .1 Installer to be specialist in performing work of this Section, and have at least five (5) years successful experience in this size and type of project, qualified to standards of TIAC.

1.3 DELIVERY, STORAGE AND HANDLING

- .1 Deliver materials to site in original factory packaging, labelled with manufacturer's name, address.
- .2 Protect from weather, construction traffic.
- .3 Protect against damage from any source.
- .4 Store at temperatures and conditions required by manufacturer.

PART 2 – PRODUCTS

2.1 ROOF DRAIN

- .1 Standard of Acceptance: based on Zurn ZA100 15" (381mm) diameter roof drain, or approved alternate.
 - .1 Cast iron body with combination membrane flashing clamp/gravel guard.
 - .2 Under-deck clamps.
 - .3 Aluminum Dome.
 - .4 4" (100mm) Outlet.

2.2 CAST IRON PIPING AND FITTINGS: FOR INTERIOR WORK

- .1 Above ground sanitary storm and vent: to CAN/CSA B70.
 - .1 Mechanical joints: Neoprene or butyl rubber compression gaskets with stainless steel clamps.

2.3 THERMAL INSULATION FOR PIPING

- .1 Fire and smoke rating:
 - .1 In accordance with CAN/ULCS102.
 - .1 Maximum flame spread rating: 25.
 - .2 Maximum smoke developed rating: 50.
-

-
- .2 Insulation:
 - .1 Mineral fibre specified includes glass fibre, rock wool, slag wool.
 - .2 Thermal conductivity ("k" factor) not to exceed specified values at 24 C mean temperature when tested in accordance with ASTM C335.
 - .3 TIAC Code A3: Rigid moulded mineral fibre with factory applied vapour retarder jacket.
 - .1 Mineral fibre: to CAN/ULC S702 and ASTM C547.
 - .2 Jacket: to CGSB 51GP52Ma.
 - .3 Maximum "k" factor: to CAN/ULC S702.
 - .4 TIAC Code C2: Mineral fibre blanket faced with factory applied vapour retarder jacket (as scheduled in PART 3 of this section).
 - .1 Mineral fibre: to CAN/ULCS702.
 - .2 Jacket: to CGSB 51GP52Ma.
 - .3 Maximum "k" factor: to CAN/ULC S702.
 - .5 TIAC Code A6: flexible unicellular tubular elastomer.
 - .1 Insulation: with vapour retarder jacket to ASTM C534.
 - .2 Jacket: to CGSB 51GP52Ma.
 - .3 Maximum "k" factor: 0.039 W/mC.
 - .4 To be certified by manufacturer to be free of potential stress, corrosion, and/or cracking.
 - .5 Flame spread index less than 25 and smoke developed index less than 50.
 - .6 Acceptable Manufacturers: Manson, Knauf, Owens Corning.
 - .3 Insulation Securement:
 - .1 Tape: Self-adhesive, aluminum, plain reinforced, 50 mm wide minimum.
 - .2 Contact adhesive: Quick setting.
 - .3 Canvas adhesive: Washable.
 - .4 Tie wire: 1.5 mm diameter stainless steel.
 - .5 Bands: Stainless steel, 19 mm wide, 0.5 mm thick.
 - .4 Thermal insulating and finishing cement:
 - .1 Hydraulic setting or air drying on mineral wool, to ASTM C449/C449M.
 - .5 Vapour Retarder Lap Adhesive:
 - .1 Water based, fire retardant type, compatible with insulation.
 - .6 Indoor Vapour Retarder Finish:
 - .1 Vinyl emulsion type acrylic, compatible with insulation.
 - .2 For Type A6 insulation to manufacturer's recommendation.
 - .8 Jackets:
 - .1 Canvas:
 - .1 220gm/m² cotton, plain weave, treated with dilute fire retardant lagging adhesive to ASTM C921.
 - .2 Lagging adhesive: Compatible with insulation.
 - .2 Aluminum:
 - .1 To ASTM B209.
 - .2 Thickness: 0.40 mm sheet.
 - .3 Finish: Stucco embossed or corrugated.
 - .4 Joining: Longitudinal and circumferential slip joints with 50 mm laps.
-

- .5 Fittings: 0.5 mm thick die shaped fitting covers with factory attached protective liner.
- .6 Metal jacket banding and mechanical seals: stainless steel, 19 mm wide, 0.5 mm thick at 300 mm spacing.
- .3 Self-adhesive Weather Barrier Membrane:
 - .1 Flexible SBS modified membrane impermeable to air, moisture vapour and water. UV light resistant, flame free adhesion.
 - .2 Henry Bakor Foilskin, or approved equivalent.

PART 3 - EXECUTION

3.1 PIPE INSTALLATION

- .1 Install in accordance with Canadian Plumbing Code and local authority having jurisdiction.
- .2 Install piping parallel and close to walls to conserve headroom and space, and grade as indicated.
- .3 Provide pipe firestop barriers and/or collars on the underside of fire-rated floors and both sides of fire-rated partitions that are penetrated.
 - .1 Acceptable Manufacturer: 3M Firestop.

3.2 PERFORMANCE VERIFICATION

- .1 Storm Water Drainage:
 - .1 Verify domes are secure.
 - .2 Confirm weirs are correctly sized and installed correctly.
 - .3 Verify provisions for movement of roof system.
 - .4 Confirm fixtures are properly anchored, connected to system and effectively vented.
 - .5 Affix applicable label (storm, sanitary, vent, pump discharge etc.) complete with directional arrows every floor or 4.5 m (whichever is less).
- .2 Pressure testing of piping systems and adjacent equipment to be complete, witnessed and certified.
- .3 Surfaces clean, dry, and free from foreign material.

3.3 INSULATION INSTALLATION

- .1 Install in accordance with TIAC National Standards.
 - .2 Apply materials in accordance with manufacturer's instructions and this specification.
-

- .3 Use two (2) layers with staggered joints when required nominal wall thickness exceeds 75 mm.
- .4 Maintain uninterrupted continuity and integrity of vapour retarder jacket and finishes.
 - .1 Hangers, supports to be outside vapour retarder jacket.
- .5 Supports, Hangers:
 - .1 Apply high compressive strength insulation, suitable for service, at oversized saddles and shoes where insulation saddles have not been provided.

3.4 REMOVABLE, PRE-FABRICATED INSULATION AND ENCLOSURES

- .1 Application: At expansion joints, valves, primary flow measuring elements flanges and unions at equipment.
- .2 Design: To permit movement of expansion joint and to permit periodic removal and replacement without damage to adjacent insulation.
- .3 Insulation:
 - .1 Insulation, fastenings and finishes: same as system.
 - .2 Jacket: Aluminum, PVC high temperature fabric.

3.5 INSTALLATION OF ELASTOMERIC INSULATION

- .1 Insulation to remain dry at all times. Overlaps to manufacturer's instructions. Ensure tight joints.
- .2 Provide vapour retarder as recommended by manufacturer.

END

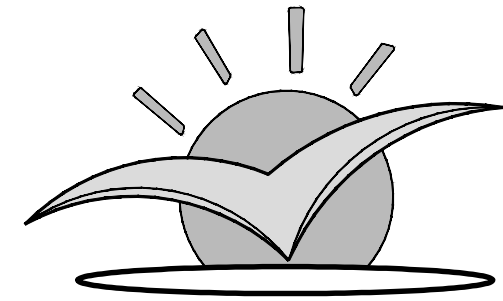

**Halifax Regional
School Board**

DRAWING LIST:

ARCHITECTURAL

A100 ROOF PLAN, LEGEND
& NOTES

A101 ROOF DETAILS
A102 ROOF DETAILS
A103 ROOF DETAILS

**MICHAEL WALLACE ELEMENTARY
SCHOOL ROOF REPLACEMENT**

24 ANDOVER ST
DARTMOUTH, NS

PROJECT NO.: 149-12436-00
ISSUE DATE: JULY 18, 2014

ISSUED FOR TENDER

ARCHITECT



ARCHITECTURE | 49

1640 Market Street, Halifax, Nova Scotia, Canada, B3J 2C8
T:902.429.5490 F: 902.429.2632 www.architecture49.com

GENERAL NOTES

1. CONTRACTOR TO VERIFY ALL DIMENSIONS & ACTUAL CONDITIONS ON SITE.
2. REVIEW ALL EXISTING WOOD BLOCKING, EXISTING WOOD DECK & ALL EXISTING SLEEPERS FOR ANY DAMAGE & DETERIORATION PRIOR TO INSTALLING ROOF MEMBRANE, REFER TO UNIT PRICE IF REPLACEMENT IS REQUIRED.
3. REMOVE ANY REDUNDANT MECHANICAL CURBS & SUPPORTS PRIOR TO INSTALLATION OF NEW ROOF CONSTRUCTION.

LEGEND

-  EXISTING 2-PLY MOD. BIT. ROOF TO REMAIN
-  EXHAUST VENTILATOR / DUCT (EV) [EXISTING UNLESS OTHERWISE NOTED]
-  ROOF DRAIN (RD) [EXISTING UNLESS OTHERWISE NOTED]

N.T.S. **1** LEGEND & NOTES

A-100

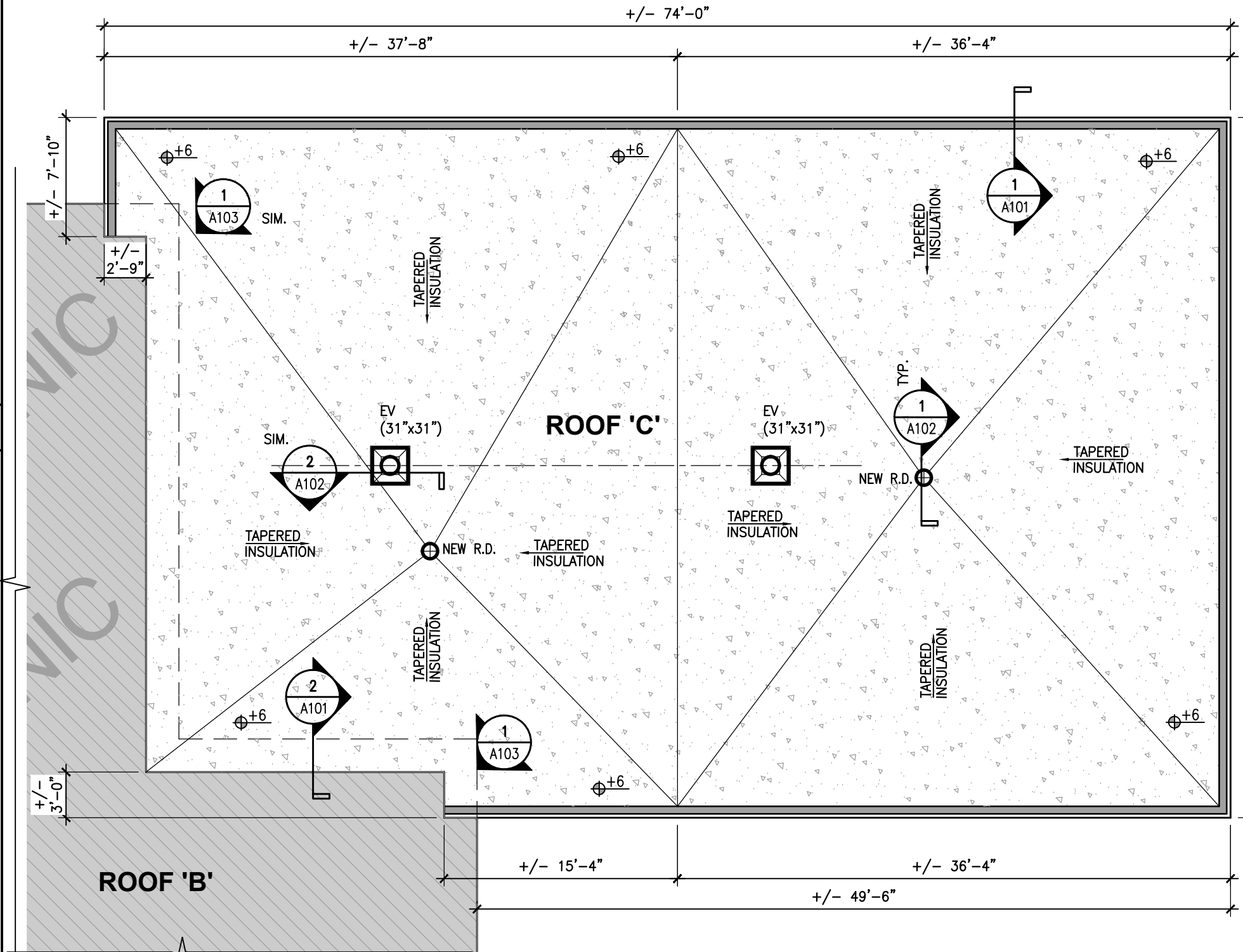

1/8" = 1'-0" **2** ROOF PLAN

A-100



Architect:
ARCHITECTURE | 49
 1640 Market Street, Halifax Nova Scotia, Canada, B3J 2C8
 T: 902-429-5490 F: 902-429-2632 www.architecture49.com

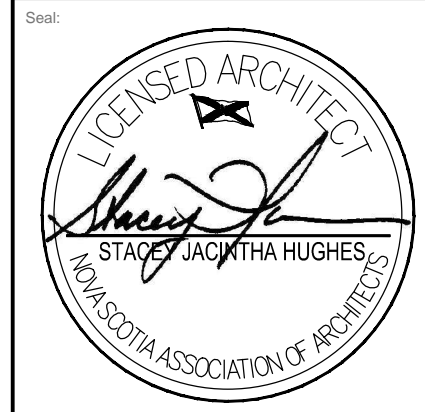

Drawn: **OMK/JW** Scale: **AS NOTED**
 Checked: **SH** Approved: **SH**
 Date: **JUNE 18, 2014**

Project:
MICHAEL WALLACE ELEMENTARY SCHOOL ROOF REPLACEMENT
 City: **Dartmouth** Province: **NS**

Title:
ROOF PLAN, LEGEND, & NOTES

Commission No.:
 Project No.: **149-12436-00**
 Contract No.:
 DWG No.:

A-100

CONTRACTOR TO CONFIRM ALL DIMENSIONS ON SITE

DEMOLITION. TYP.

REMOVE EXISTING ROOFING INCLUDING FIBREBOARD, RIGID INSULATION AND VAPOUR RETARDER TO EXPOSE WOOD DECK BELOW

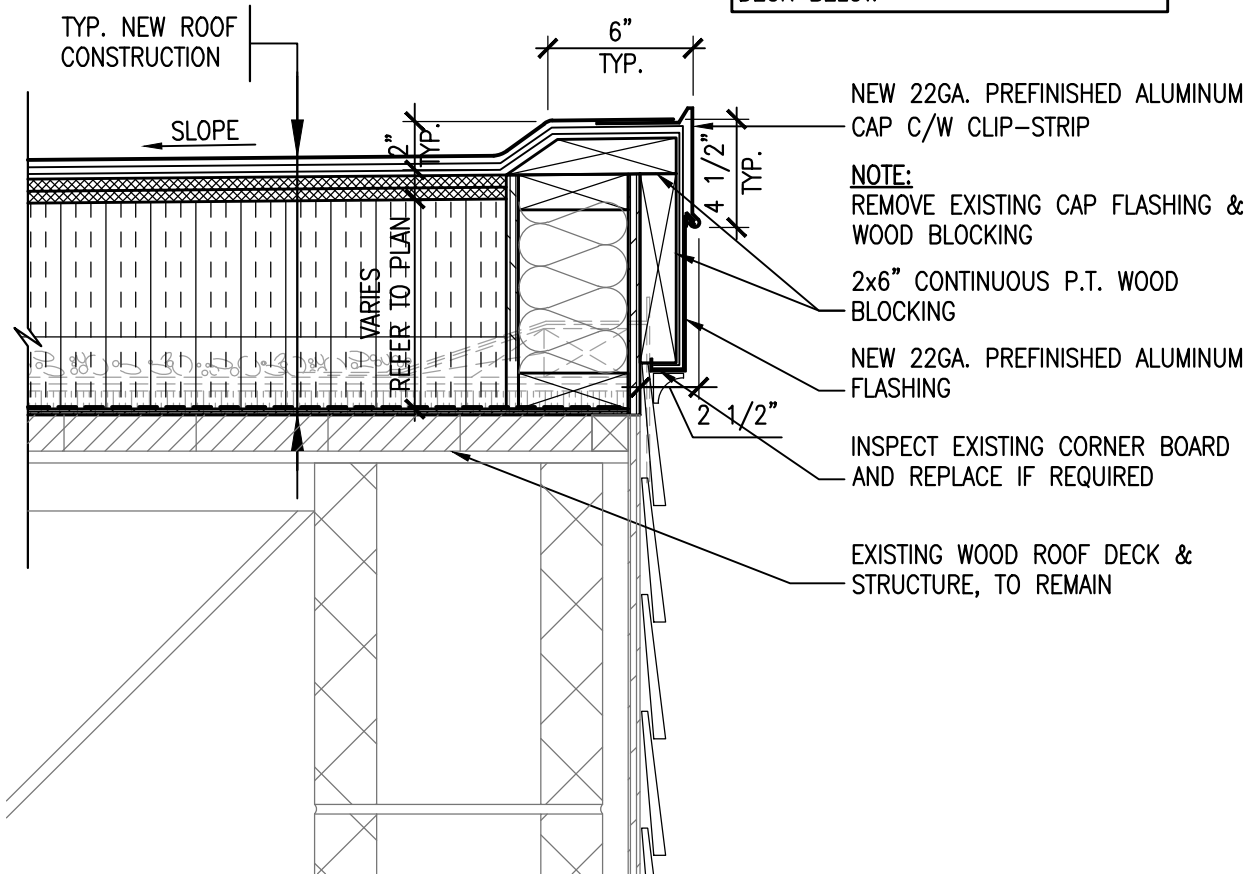

1 1/2"=1'-0" **1** TYPICAL PARAPET DETAIL
A-101

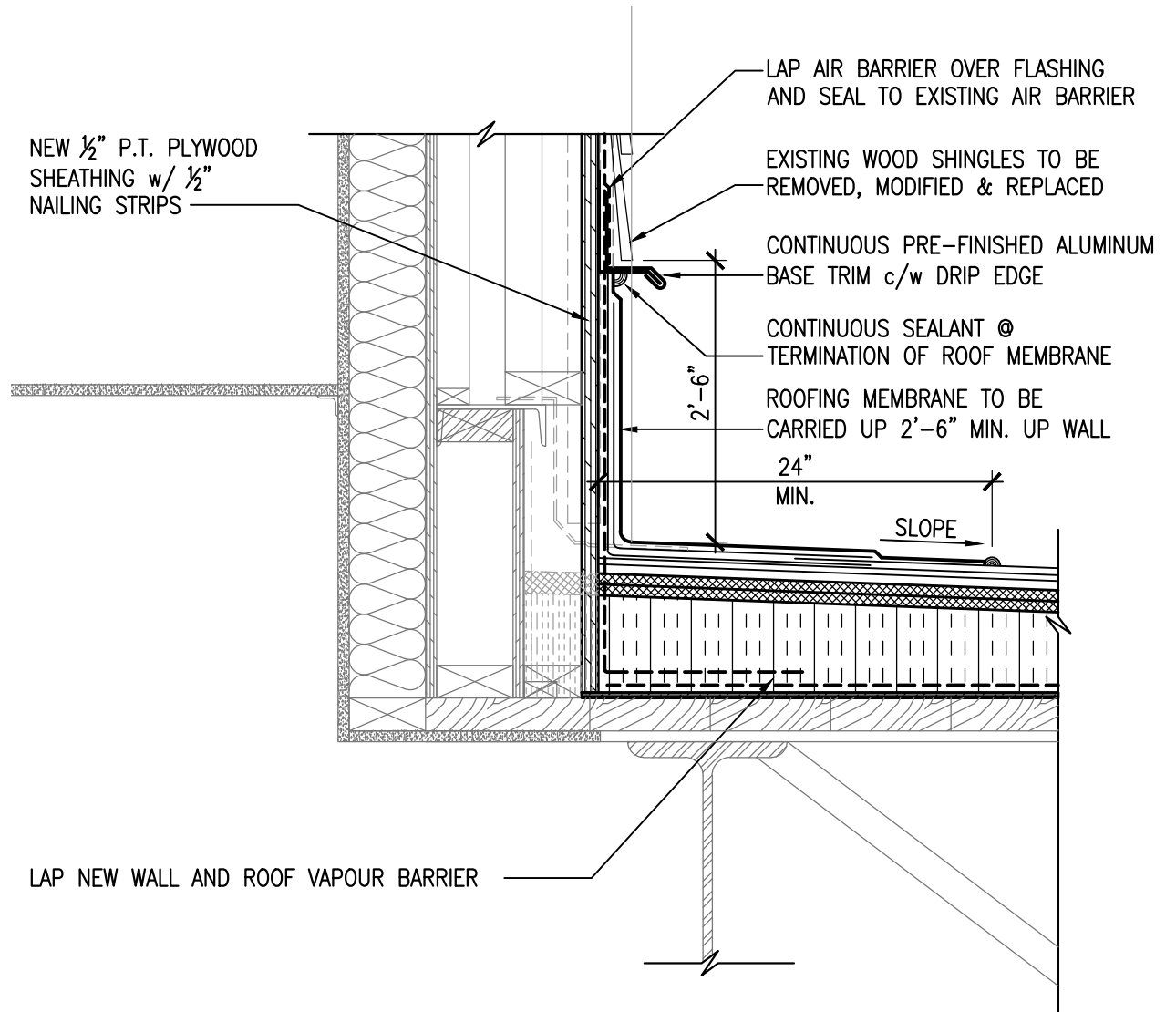

1 1/2"=1'-0" **2** TYPICAL DETAIL @ EXISTING WALL BASE
A-101



Client:

ARCHITECTURE | 49

1640 Market Street, Halifax Nova Scotia, Canada, B3J 2C8
T: 902-429-5490 F: 902-429-2632 www.architecture49.com



Drawn: OMK/JW Scale: AS NOTED

Checked: SH Approved: SH

Date: JUNE 18, 2014

Project: MICHAEL WALLACE ELEMENTARY SCHOOL ROOF REPLACEMENT

City: Dartmouth Province: NS

Title: ROOF DETAILS

Commission No.:

Project No.: 149-12436-00

Contract No.:

DWG No.:

A-101

NOTE:
 REMOVE EXISTING ROOF DRAIN, VERIFY
 CONDITION OF ROOF DECK, IF OK, INSTALL
 NEW ROOF DRAIN IN EXISTING LOCATION.
 CONNECT INTO EXISTING RAIN WATER LEADER,
 CONTRACTOR TO ENSURE THROAT SIZE
 TO MATCH EXISTING PIPE SIZE.
 ROOF DRAIN TO BE ZURN ZA-105

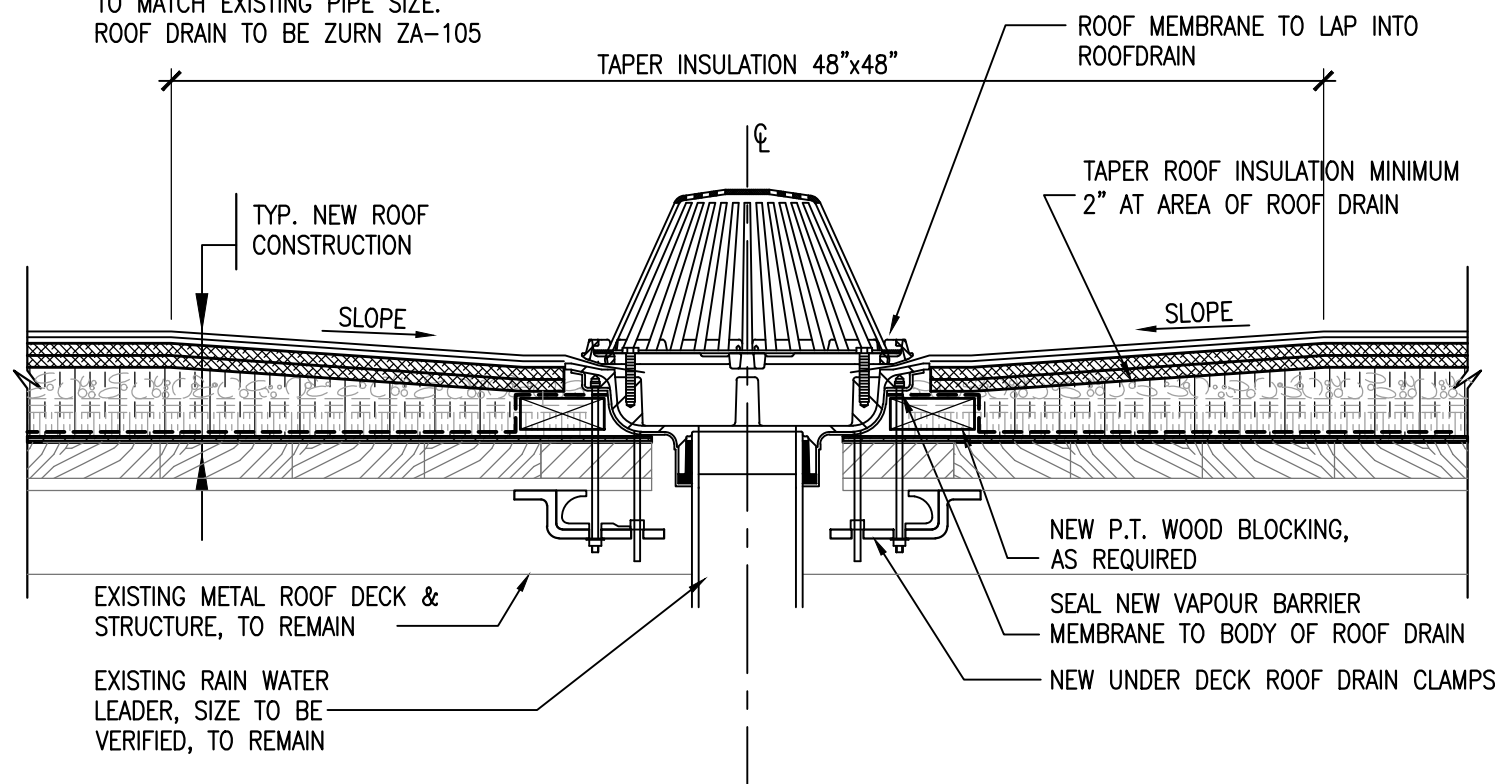

1 1/2"=1'-0" **1** TYPICAL NEW ROOF @ EXISTING ROOF DRAIN

A-102

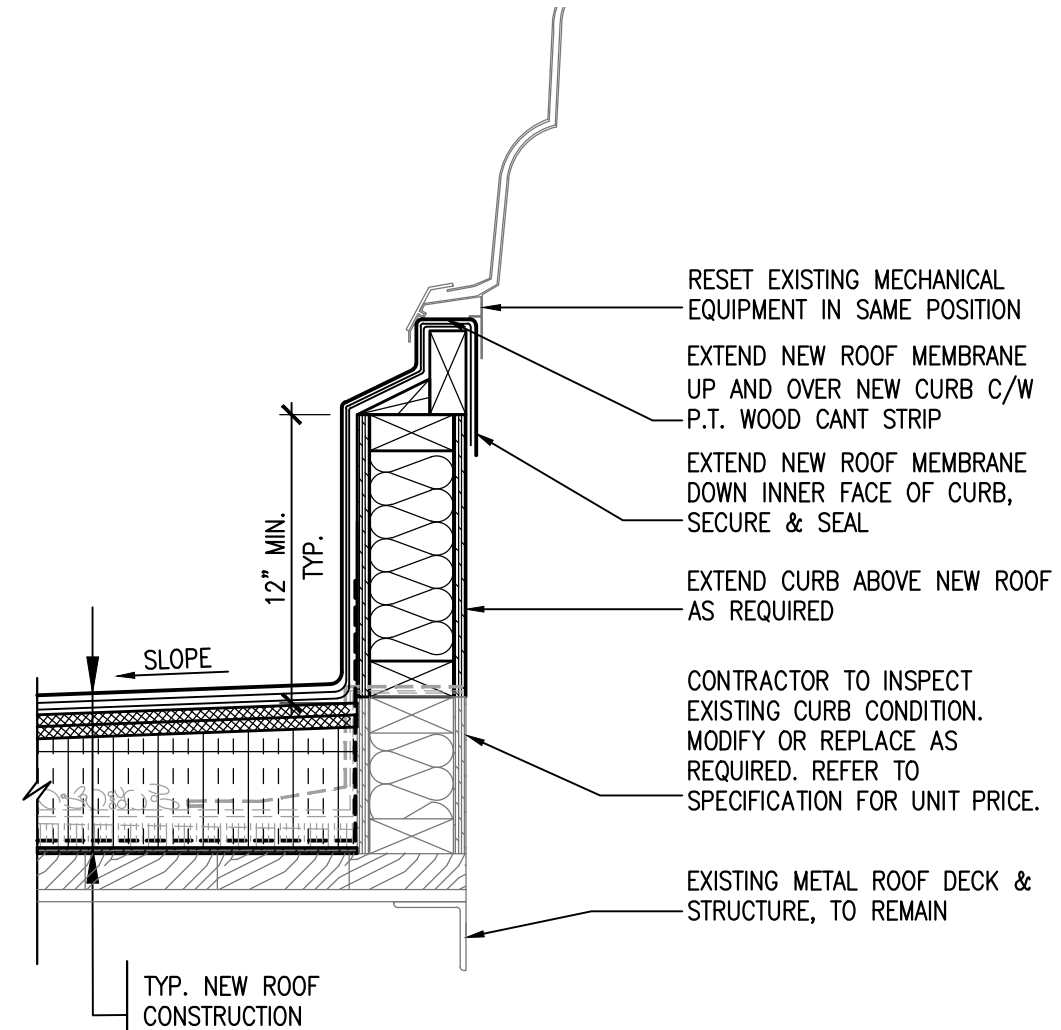

1 1/2"=1'-0" **2** TYPICAL CURB DETAIL

A-102

Client:

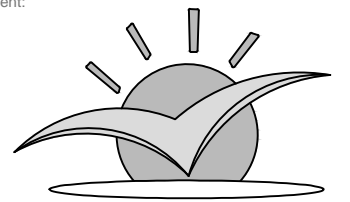

**Halifax Regional
 School Board**

Architect:

ARCHITECTURE | 49

1640 Market Street, Halifax Nova Scotia, Canada, B3J 2C8
 T: 902-429-5490 F: 902-429-2632 www.architecture49.com

Seal:

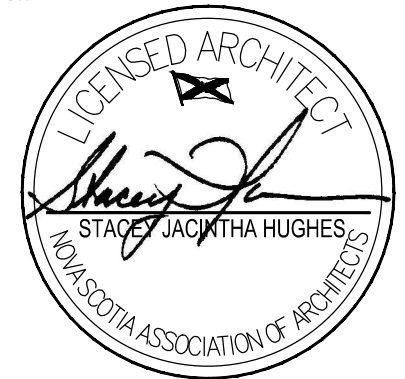

Drawn: OMK/JW Scale: AS NOTED

Checked: SH Approved: SH

Date: JUNE 18, 2014

Project:
**MICHAEL WALLACE
 ELEMENTARY SCHOOL
 ROOF REPLACEMENT**

City: Dartmouth Province: NS

Title:
ROOF DETAILS

Commission No.:

Project No.: 149-12436-00

Contract No.:

DWG No.:

A-102

1

2

3

4

A

B

C

D

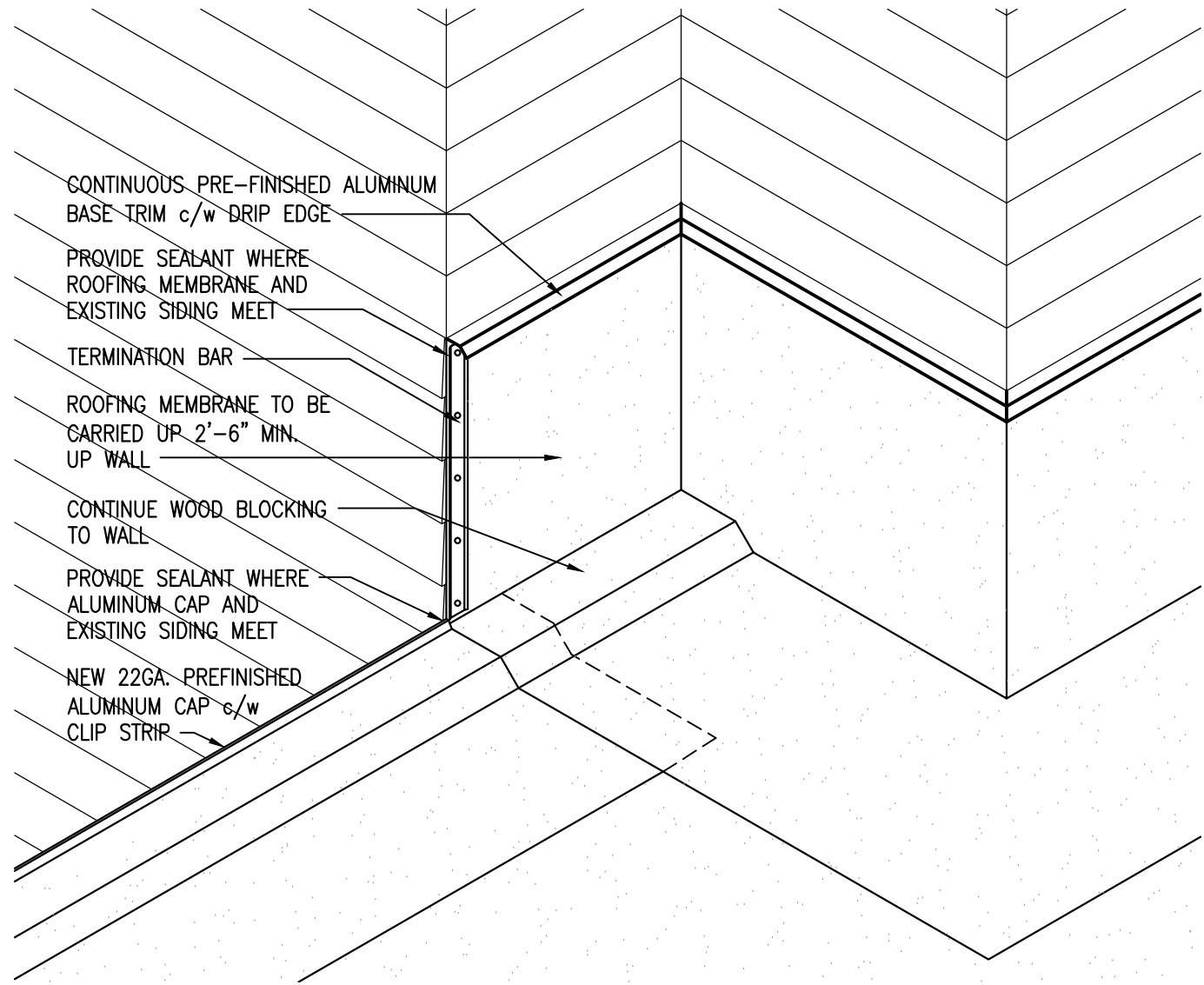

3/4"=1'-0" **1** ISOMETRIC DETAIL VIEW

A-103

Client:

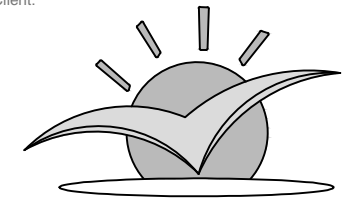

**Halifax Regional
School Board**

Architect:

ARCHITECTURE | 49

1640 Market Street, Halifax Nova Scotia, Canada, B3J 2C8
T: 902-429-5490 F: 902-429-2632 www.architecture49.com

Seal:

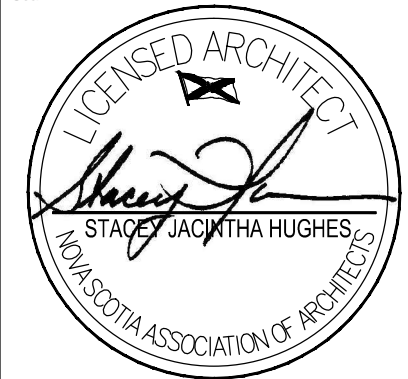

Drawn: **OMK/JW** Scale: **AS NOTED**

Checked: **SH** Approved: **SH**

Date: **JUNE 18, 2014**

Project:
**MICHAEL WALLACE
ELEMENTARY SCHOOL
ROOF REPLACEMENT**

City: **Dartmouth** Province: **NS**

Title:
ROOF DETAILS

Commission No.:

Project No.: **149-12436-00**

Contract No.:

DWG No.:

A-103